

GROUP 42B

KEYLESS OPERATION SYSTEM (KOS)

CONTENTS

GENERAL INFORMATION	42B-2	ANTENNA COMMUNICATION TEST.....	42B-236
SPECIAL TOOLS	42B-8	TPMS TRANSMITTER CHECK.....	42B-236
DIAGNOSIS	42B-9	TPMS TRANSMITTER ID CHECK	42B-236
STANDARD FLOW OF DIAGNOSTIC TROUBLESHOOTING	42B-9	KEYLESS ENTRY SYSTEM CHECK	42B-237
DIAGNOSTIC FUNCTION	42B-9	INSPECTION OF KEYLESS ENTRY TIMER LOCK FUNCTION	42B-237
ID CODES REGISTRATION JUDGMENT TABLE	42B-11	POWER DOOR LOCKS WITH SELECTIVE UNLOCKING INSPECTION	42B-237
WARNING AND WARNING INDICATOR LIST	42B-15	CUSTOMIZATION FUNCTION	42B-238
DIAGNOSTIC TROUBLE CODE CHART ..	42B-23	KOS-ECU	42B-241
DIAGNOSTIC TROUBLE CODE PROCEDURES.....	42B-25	REMOVAL AND INSTALLATION	42B-241
DATA LIST REFERENCE TABLE	42B-150	EXTERIOR TRANSMITTER ANTENNA ASSEMBLY, INTERIOR TRANSMITTER ANTENNA ASSEMBLY, RECEIVER ANTENNA MODULE	42B-242
ACTUATOR TEST TABLE	42B-151	REMOVAL AND INSTALLATION	42B-242
TROUBLE SYMPTOM CHART.....	42B-152	KEYLESS OPERATION KEY	42B-245
SYMPTOM PROCEDURES	42B-152	DISASSEMBLY AND ASSEMBLY	42B-245
TERMINAL VOLTAGE REFERENCE CHART	42B-225	TPMS TRANSMITTER	42B-247
ON-VEHICLE SERVICE	42B-227	REMOVAL AND INSTALLATION	42B-247
ID CODES REGISTRATION PROCEDURES.....	42B-227		

GENERAL INFORMATION

M1429600100280

NOTE: In this manual, F.A.S.T.-key (Free-hand Advanced Security Transmitter) is described as Keyless Operation System (KOS). (KOS is indicated as F.A.S.T. in the scan tool display.)

The keyless operation system (KOS) enables the driver to unlock all the doors and the trunk lid by just pulling the front door outside handle or operating the trunk lid open switch, without taking the key out from his/her pocket or bag when he/she is carrying a keyless operation key that is registered to the vehicle's KOS-ECU. (When the driver's front door outside handle is operated, only the driver's door is unlocked.) KOS also allows the driver to lock all the doors by pressing the lock switch on the front door outside handle (door entry function), and start the engine without using the conventional mechanical key (engine start function). Moreover, KOS incorporates the keyless entry function with which, like the conventional keyless entry system, a driver can perform the remote operation (opening/closing of all the doors, opening of the trunk lid, warning function to warn a person who intends to damage the vehicle^{*}) by operating the lock/unlock button, trunk lid button, and panic button on the keyless operation key. The system also incorporates the immobilizer function that prohibits the starting of engine by using an unau-

thorized key as well as the tire pressure monitoring system (TPMS) that issues a warning to a driver by illuminating or flashing the warning light if an abnormality to the tire pressure or the system error is detected. KOS has the following features:

- Each vehicle is provided with two keyless operation keys, and up to four keyless operation keys can be equipped.
- The keyless operation key also incorporates an indicator light that enables the driver to check if the signal is transmitted correctly or if the battery in the key is discharged.
- The keyless operation key incorporates an emergency key to lock/unlock the front doors when the battery in the keyless operation key is discharged or the keyless operation system is not working normally. Also by using it simultaneously with the keyless operation key (insert the emergency key into the keyless operation key in the inverted direction), the engine can be started.

NOTE: If the immobilizer related system failure occurs, the engine may not start.

- The driver can customize KOS; enabling the door entry/engine start function, disabling the door entry/engine start function, enabling the door locking/unlocking function only, or enabling the engine starting function only.

NOTE: ^{}: Horn sounds and the headlight flashes.*

CONSTRUCTION DIAGRAM

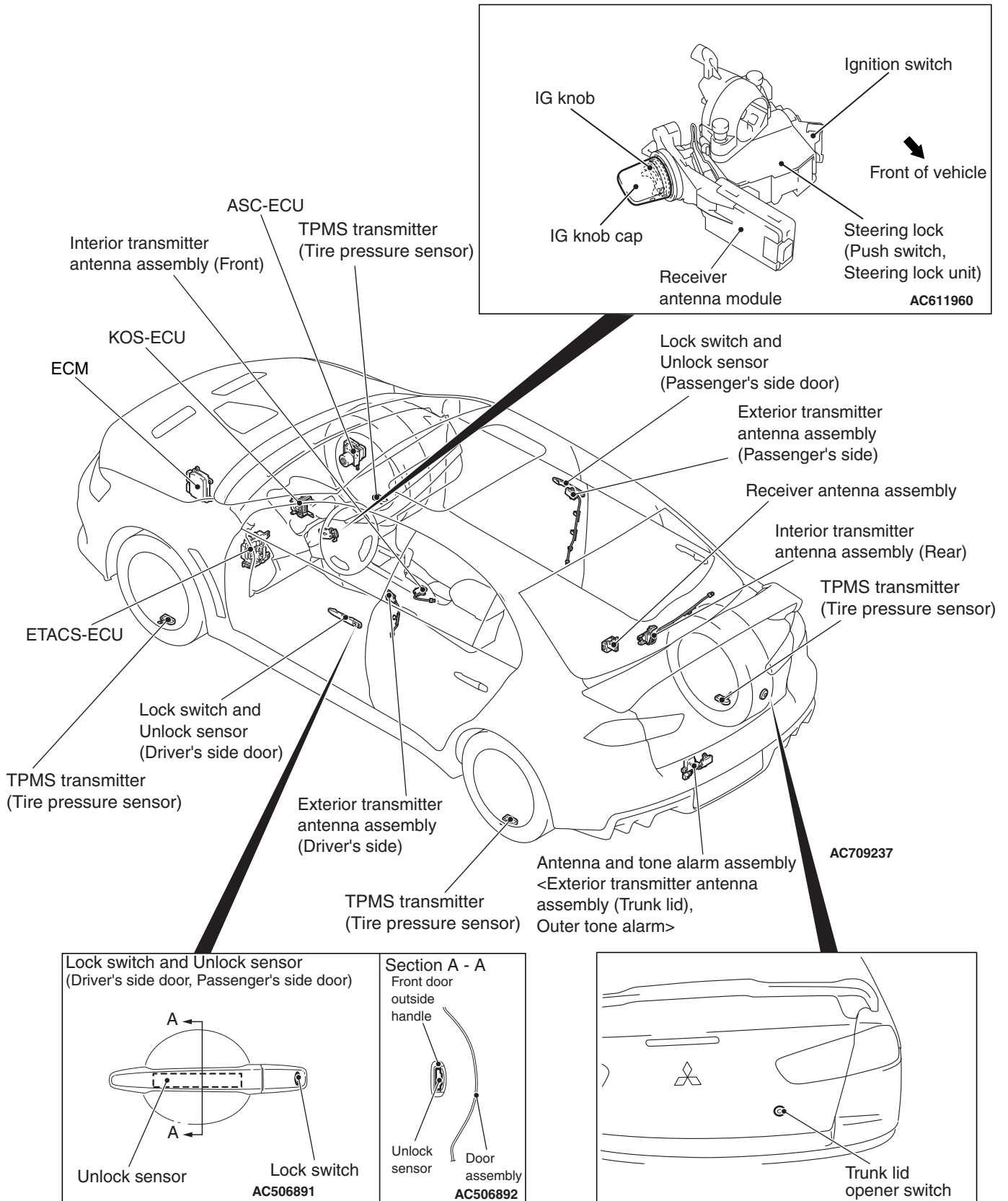

AC709242AB

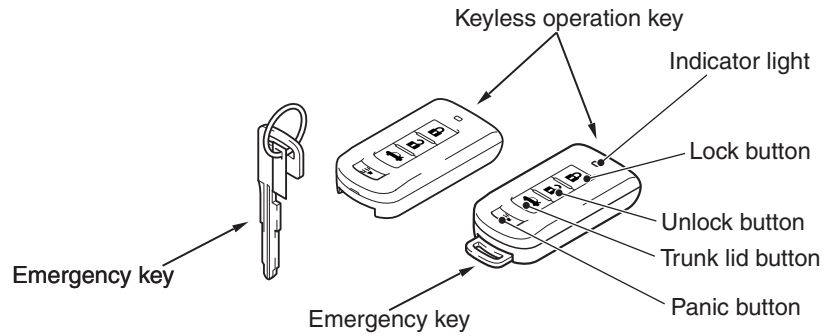
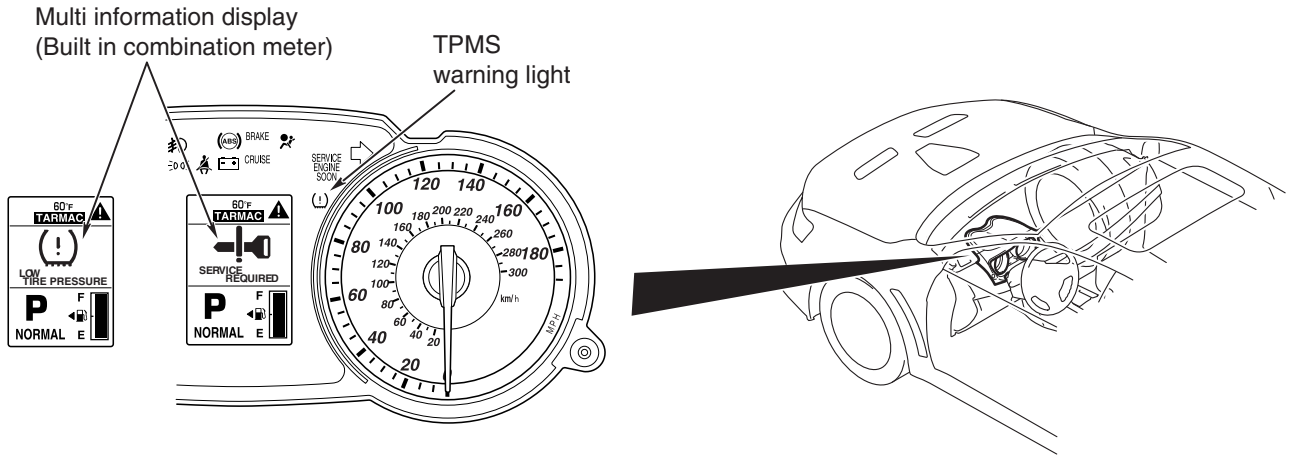

Main components and functions

Parts name		Functional description
KOS-ECU		<p>Controls KOS by using the following inputs/outputs and communications.</p> <ul style="list-style-type: none"> • Input from the unlock sensor and lock switch on each door, input from the push switch on the IG knob • Communications with ETACS-ECU, ECM or ASC-ECU and combination meter via CAN • Wire communication with the steering lock unit • Wireless communication with the keyless operation key via the receiver antenna module, receiver antenna assembly and interior/exterior transmitter antennas • Wireless communication with the TPMS transmitter • Output to the outer tone alarm
Steering lock (incorporates push switch and steering lock unit)		<p>The steering lock has two unlocking mechanisms; a mechanical mechanism that uses an emergency key and an electrical mechanism. In the electrical unlocking mechanism, the steering lock communicates with KOS-ECU via wire, and when requested by KOS-ECU, the steering lock unlocks for two seconds.</p>
Keyless operation key (incorporates emergency key)		<ul style="list-style-type: none"> • The keyless operation key receives signals sent from each interior/exterior transmitter antenna, certifies the keyless operation key ID code, calculates the key ID, and sends the reply data signal to KOS-ECU via the receiver antenna assembly. The lock button, unlock button, and trunk lid button operations of keyless operation key transmit signals to KOS-ECU via the receiver antenna assembly. • If two or more keyless operation keys registered in KOS-ECU respond at the same time, their signals would interfere. To avoid this interference, each signal from KOS-ECU is given the priority^{*1} data, and the keyless operation keys respond in accordance with this priority.
Lock switch	Driver's door	<p>Locks all the doors when a driver carrying the keyless operation key presses the lock switch on the front door outside handle.</p>
	Front passenger's door	
Unlock sensor	Driver's door	<p>The unlock sensors incorporated in the driver's front door outside handles unlock driver's the door when a driver carrying the keyless operation key pulls the driver's door outside handle.</p>
	Front passenger's door	<p>The unlock sensors incorporated in the passenger's front door outside handles unlock all the doors when a driver carrying the keyless operation key pulls the front door outside handle.</p>
Trunk lid opener switch		<p>By pressing the trunk lid opener switch on the trunk lid while he/she is carrying the keyless operation key, the trunk lid is unlocked.</p> <p><i>NOTE: With the locking of trunk lid, the locking is performed mechanically when the trunk lid is closed.</i></p>
Exterior transmitter antenna assembly	Driver's side	<p>Converts the data output from KOS-ECU via wire into a signal, and sends it to the keyless operation key.</p>
	Front passenger's side	

Parts name		Functional description
Interior transmitter antenna assembly	Front	Converts the data output from KOS-ECU via wire into a signal, and sends it to the keyless operation key.
	Rear	
Antenna & tone alarm assembly	Exterior transmitter antenna assembly (trunk lid)	Converts the data output from KOS-ECU via wire into a signal, and sends it to the keyless operation key.
	Outer tone alarm	The outer tone alarm sounds when: <ul style="list-style-type: none"> • The doors are locked or unlocked by the door entry function. • The keyless operation key is take out of the vehicle when the IG knob is in the "LOCK" (OFF) position and the push switch is in other than the ON position. • The lock switch on the keyless operation switch is pressed when the IG knob is in the "LOCK" (OFF) position and the push switch is in other than the ON position. • The lock switch on the keyless operation key is pressed from inside the car. • The lock switch on the keyless operation key is pressed when the door is ajar.
Receiver antenna module		Receives the keyless operation key ID data from the keyless operation key which is needed for the engine start, and then outputs the data to KOS-ECU.
Receiver antenna assembly		Receives the operation signals from the lock/unlock buttons, trunk lid button, and panic button on the keyless operation key as well as the keyless operation key ID data which is necessary for engine start and the tire pressure signal from the TPMS transmitter. Then, sends the data to KOS-ECU.
TPMS transmitter		Measure tire pressure directly, then send radio frequency signal to receiver antenna assembly.
Combination meter (Multi information display, TPMS warning light)		Communicates with KOS-ECU via CAN. Receives the warning request or warning information from KOS-ECU, activates ^{*2} the warning light. Warning symbol and message is additionally displayed on the multi information display
ETACS-ECU		Communicates with KOS-ECU via CAN. By the door lock/unlock request, trunk open request, or panic alarm request from KOS-ECU, ETACS-ECU outputs the lock/unlock signal, trunk open signal, or panic alarm signal. When the door lock/unlock signal is output, ETACS-ECU flashes or illuminates the turn signal light and dome light to notify that the lock/unlock operation is performed.
ECM		Communicates with KOS-ECU via CAN. Permits/inhibits the engine starting and controls the engine operation. Send atmospheric pressure data.
ASC-ECU		Communicates with KOS-ECU via CAN. Sends the vehicle speed data.

NOTE: *1: When registering the keyless operation keys, KOS-ECU numbers each key (1 to 4) in the order they are registered (initial priority). This priority is renewed each time the doors are locked/unlocked and the IG knob is pressed. For example, when only keys 1 and 3 have responded to the signal sent from

KOS-ECU, the new priority of the keys would be 1-3-2-4. When keys 3 and 4 have responded, then the priority of the keys becomes 3-4-1-2.

NOTE: *2: Illuminates for tire pressure warning. Flashes for about 1 minute and then continuously illuminated for TPMS malfunction warning.

System configuration

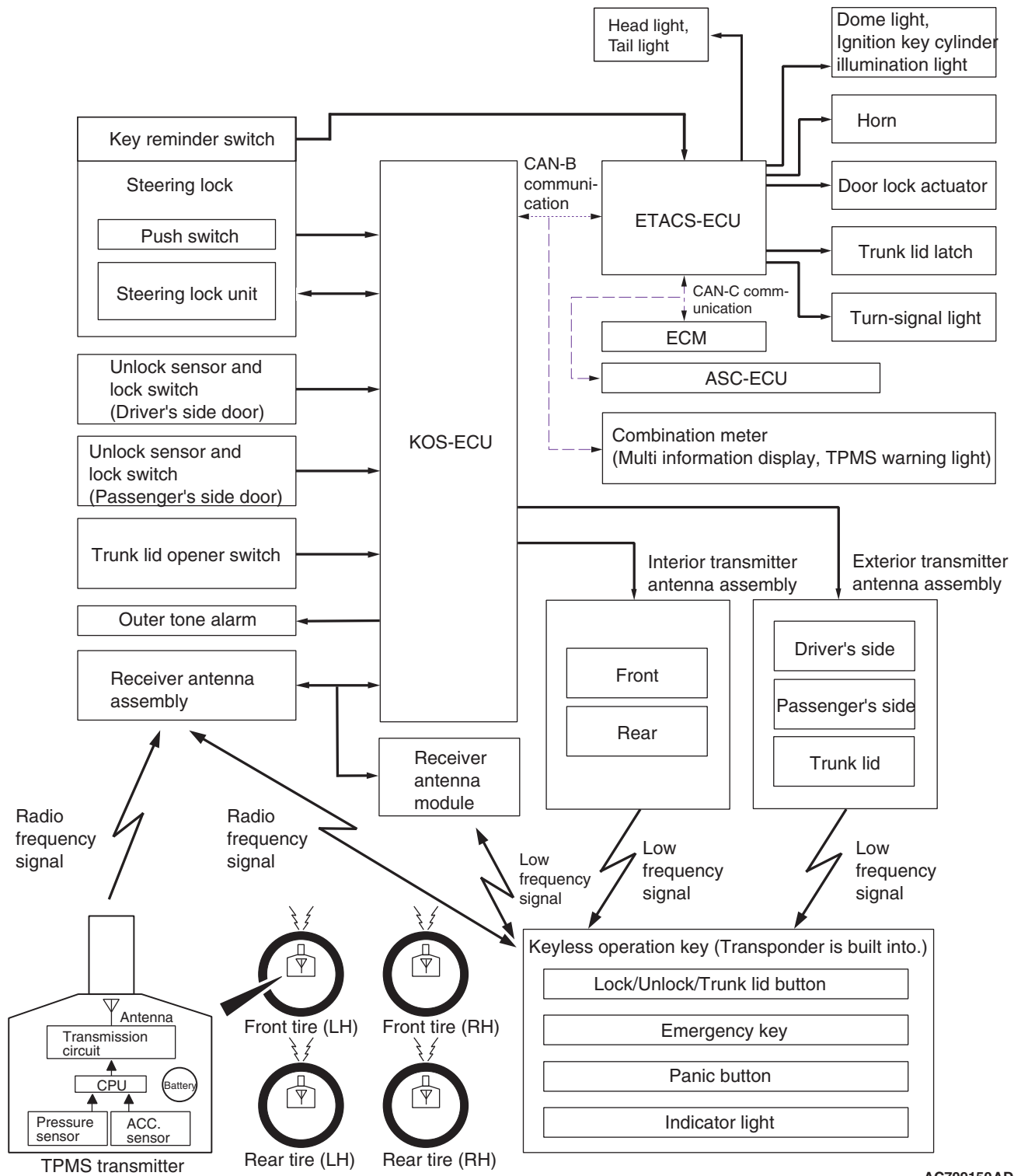

AC709150AD

SPECIAL TOOLS

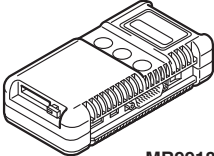
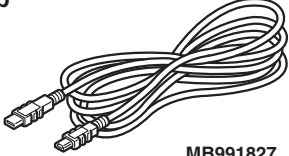
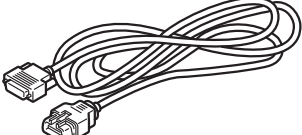
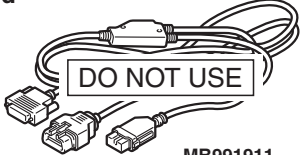
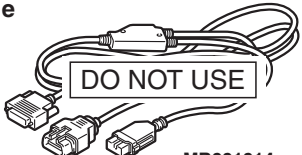
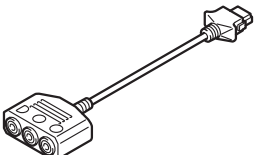
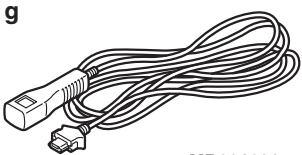
Tool	Tool number and name	Supersession	Application
<p>a</p>  <p>MB991824</p> <p>b</p>  <p>MB991827</p> <p>c</p>  <p>MB991910</p> <p>d</p>  <p>MB991911</p> <p>e</p>  <p>MB991914</p> <p>f</p>  <p>MB991825</p> <p>g</p>  <p>MB991826 MB991958</p>	<p>MB991958</p> <p>a. MB991824</p> <p>b. MB991827</p> <p>c. MB991910</p> <p>d. MB991911</p> <p>e. MB991914</p> <p>f. MB991825</p> <p>g. MB991826</p> <p>M.U.T.-III sub assembly</p> <p>a. Vehicle communication interface (V.C.I.)</p> <p>b. M.U.T.-III USB cable</p> <p>c. M.U.T.-III main harness A (Vehicles with CAN communication system)</p> <p>d. M.U.T.-III main harness B (Vehicles without CAN communication system)</p> <p>e. M.U.T.-III main harness C (for Chrysler models only)</p> <p>f. M.U.T.-III measurement adapter</p> <p>g. M.U.T.-III trigger harness</p>	<p>MB991824-KIT</p> <p><i>NOTE: G: MB991826 M.U.T.-III Trigger Harness is not necessary when pushing V.C.I. ENTER key.</i></p>	<p>⚠ CAUTION</p> <p>M.U.T.-III main harness A (MB991910) should be used. M.U.T.-III main harness B and C should not be used for this vehicle.</p> <p>ETACS-ECU check (Diagnostic trouble code, service data)</p>

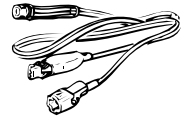
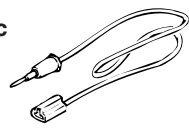
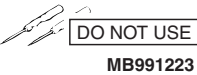
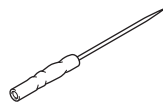
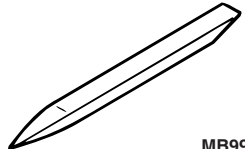
Tool	Tool number and name	Supersession	Application
<p>a </p> <p>b </p> <p>c </p> <p>d  MB991223</p>	<p>MB991223</p> <p>a. MB991219</p> <p>b. MB991220</p> <p>c. MB991221</p> <p>d. MB991222</p> <p>Harness set</p> <p>a. Test harness</p> <p>b. LED harness</p> <p>c. LED harness adaptor</p> <p>d. Probe</p>	General service tools	<p>Continuity check and voltage measurement at harness wire or connector for loose, corroded or damaged terminals, or terminals pushed back in the connector.</p> <p>a. Connector pin contact pressure inspection</p> <p>b. Power circuit inspection</p> <p>c. Power circuit inspection</p> <p>d. Commercial tester connection</p>
 MB992006	<p>MB992006</p> <p>Extra fine probe</p>	–	Making voltage and resistance measurement during troubleshooting
 MB990784	<p>MB990784</p> <p>Ornament remover</p>	General service tool	Removal of steering column cover.

DIAGNOSIS

STANDARD FLOW OF DIAGNOSTIC TROUBLESHOOTING

M1429604400078

Refer to GROUP 00 –How to Use Troubleshooting/Inspection Service Points [P.00-7](#).

DIAGNOSTIC FUNCTION

M1429605400297

HOW TO CONNECT THE SCAN TOOL (M.U.T.-III)

Required Special Tools:

- MB991958: Scan Tool (M.U.T.-III Sub Assembly)
 - MB991824: Vehicle Communication Interface (V.C.I.)
 - MB991827: M.U.T.-III USB Cable
 - MB991910: M.U.T.-III Main Harness A

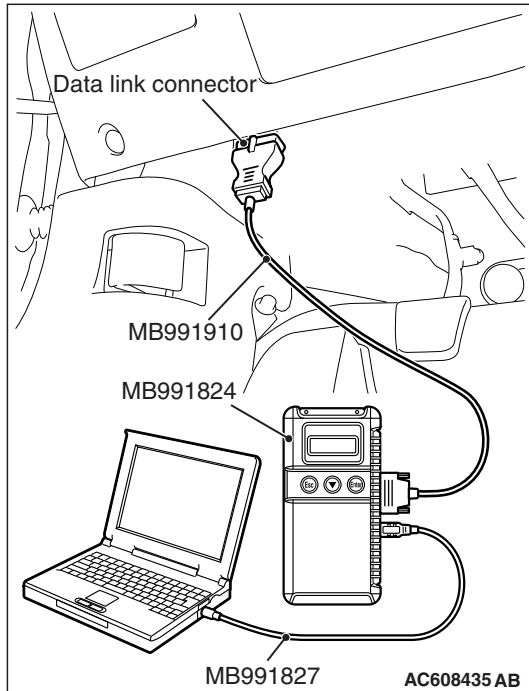
**⚠ CAUTION**

To prevent damage to scan tool MB991958, always turn the ignition switch to the "LOCK" (OFF) position before connecting or disconnecting scan tool MB991958.

1. Ensure that the ignition switch is at the "LOCK" (OFF) position.
2. Start up the personal computer.
3. Connect special tool MB991827 to special tool MB991824 and the personal computer.
4. Connect special tool MB991910 to special tool MB991824.
5. Connect special tool MB991910 to the data link connector.
6. Turn the power switch of special tool MB991824 to the "ON" position.

NOTE: When special tool MB991824 is energized, special tool MB991824 indicator light will be illuminated in a green color.

7. Start the M.U.T.-III system on the personal computer.

NOTE: Disconnecting scan tool MB991958 is the reverse of the connecting sequence, making sure that the ignition switch is at the "LOCK" (OFF) position.

HOW TO READ AND ERASE DIAGNOSTIC TROUBLE CODES

Required Special Tools:

- MB991958: Scan Tool (M.U.T.-III Sub Assembly)
 - MB991824: Vehicle Communication Interface (V.C.I.)
 - MB991827: M.U.T.-III USB Cable
 - MB991910: M.U.T.-III Main Harness A

NOTE: If the battery voltage is low, diagnostic trouble codes will not be set. Check the battery if scan tool MB991958 does not display.

1. Connect scan tool MB991958 to the data link connector.
2. Turn the ignition switch to the "ON" position.
3. Select "System select" from the start-up screen.
4. Select "From 2006 MY" of "Model Year." When the "Vehicle Information" is displayed, check the contents.
5. Select "ETACS" from "System List", and press the "OK" button.

NOTE: When the "Loading Option Setup" list is displayed, check the applicable item.

6. Select "Diagnostic Trouble Code." to read the DTC.
7. If a DTC is set, it is shown.
8. Choose "Erase DTCs" to erase the DTC.

HOW TO DIAGNOSE THE CAN BUS LINES

Required Special Tools:

- MB991958: Scan Tool (M.U.T.-III Sub Assembly)
 - MB991824: Vehicle Communication Interface (V.C.I.)
 - MB991827: M.U.T.-III USB Cable
 - MB991910: M.U.T.-III Main Harness A

1. Connect scan tool MB991958 to the data link connector.
2. Turn the ignition switch to the "ON" position.
3. Select "CAN bus diagnosis" from the start-up screen.
4. When the vehicle information is displayed, confirm that it matches the vehicle being diagnosed.
 - If they match, go to step 8.
 - If not, go to step 5.
5. Select the "view vehicle information" button.
6. Enter the vehicle information and select the "OK" button.
7. When the vehicle information is displayed, confirm again that it matches the vehicle being diagnosed.
 - If they match, go to step 8.
 - If not, go to step 5.
8. Select the "OK" button.
9. When the optional equipment screen is displayed, choose the one which the vehicle is fitted with, and then select the "OK" button.

ID CODES REGISTRATION JUDGMENT TABLE

M1429604800418

CAUTION

Do not replace the engine control module and KOS-ECU at the same time. When replacing several ECUs, always replace one ECU at a time, register the necessary IDs in it, and then replace the next ECU.

The individual unique ID code is stored in the transponder (small transmitter) and KOS-ECU, engine control module (ECM), keyless operation key, and steering lock unit for KOS. Under the conditions shown in the table, the corresponding ID code has to be registered with KOS-ECU or the ECM again.

NOTE: The KOS-ECU memory can memorize the maximum 4 different keyless operation keys (keyless operation key ID codes and key IDs).

Item	Operation contents and procedure	Reference page for registration contents
When the engine control module is replaced.	<ol style="list-style-type: none"> 1. Registration of ENG key code. 2. VIN programmed. 	ENG key code & VIN reg (Refer to GROUP 00 –Precautions before Service –How to Perform VIN Writing P.00-22).
When KOS-ECU is replaced.	<ol style="list-style-type: none"> 1. Register the steering lock unit again. 2. VIN programmed. 3. Register all the key IDs of keyless operation keys again. 4. Register all the keyless operation key IDs of keyless operation keys again. 5. Register the TPMS transmitters. 	<ul style="list-style-type: none"> • Steering Lock Unit Registration, Key and F.A.S.T.-key^{*1} Registration and TPMS transmitter ID registration (Refer to P.42B-227). • Write the VIN (Refer to GROUP 00 –Precautions before Service –How to Perform VIN Writing).
When the receiver antenna module is replaced.	Operation is not needed.	–
When the keyless operation key is added or replaced separately	<ol style="list-style-type: none"> 1. Register all the key IDs of keyless operation keys again. 2. Register all the keyless operation key IDs of keyless operation keys again. 	Key and F.A.S.T.-key Registration (Refer to P.42B-227).
When a keyless operation key is lost.	<ol style="list-style-type: none"> 1. Register all the key IDs of keyless operation keys other than the lost one again. 2. Register all the keyless operation key IDs of keyless operation keys other than the lost one again. 	
When an emergency key is added as a unit.	Operation is not needed.	–
When an emergency key is lost as a unit.		
When the emergency key is replaced by the full service key set or the handle lock service key set is replaced by the piece.		
When the key ^{*2} is replaced by the door service key set is added by the piece.		
When TPMS transmitter is replaced.	Register the TPMS transmitters.	TPMS transmitter ID registration (Refer to P.42B-227).

NOTE:

- ^{*1}: KOS and KOS key are indicated as F.A.S.T and F.A.S.T.-key respectively in the scan tool screen.
- ^{*2}: Key (the key that can be used to lock/unlock the door or trunk lid only)

KEY SUPPLY UNIT

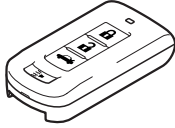
KOS emergency key	KOS key
 <p>AC610642</p>	 <p>AC709685</p>

KEY SUPPLY UNIT LIST FOR OTHER THAN INDIVIDUAL KEY

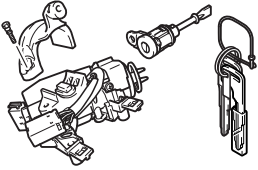
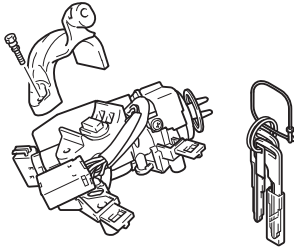
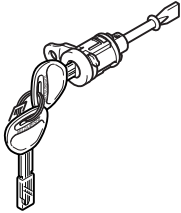
Full service key set	Handle lock service key set
 <p>AC610158</p>	 <p>AC610159</p>
<p>Door service key set (LH), Door service key set (RH) <Vehicles without keyless entry system> NOTE: Key (It can only be used for locking and unlocking, and it cannot start the engine.)</p>	
 <p>AC610062</p>	

Registration flow chart

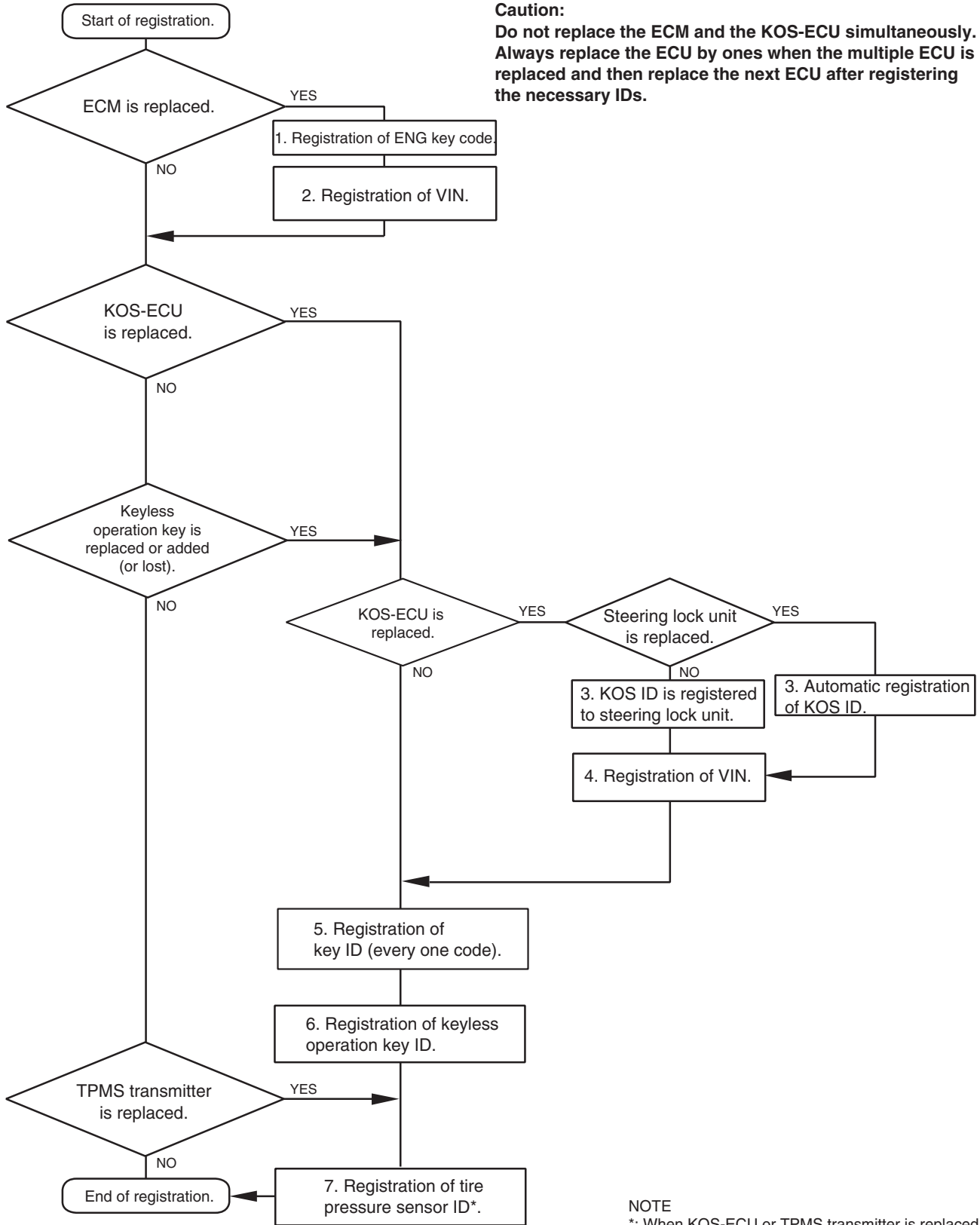



Caution:
Do not replace the ECM and the KOS-ECU simultaneously. Always replace the ECU by ones when the multiple ECU is replaced and then replace the next ECU after registering the necessary IDs.

NOTE
*: When KOS-ECU or TPMS transmitter is replaced.

WARNING AND WARNING INDICATOR LIST

If the KOS failed, operated improperly, KOS-ECU warns the driver of this by setting off the outer tone alarm and the keyless operation warning indicator, on the multi information display in the combination meter. If the TPMS fails or the tire pressure is low, KOS-ECU warns the driver of that state by the TPMS warning light and the multi information display in the combination meter.

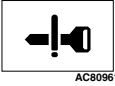

Display contents	Message	Item	State	Warning operations		Warning cancellation conditions (Cancels warning operations when one of the conditions met)
				TPMS warning light	Multi information display	
 ACB09614	KEY BATTERY LOW	Low keyless operation key battery voltage warning	The keyless operation key with low battery voltage is detected when the IG knob is pressed.	-	<ul style="list-style-type: none"> Warning indicator illuminates for 30 seconds. The outer tone alarm will not sound. 	<ul style="list-style-type: none"> IG knob in "LOCK" (OFF) position and push switch OFF are detected. 30 seconds have passed after the warning output started.
 ACB09615	KEY NOT DETECTED	No keyless operation key detected inside the car	No keyless operation key is detected inside the car when the IG knob is pressed.	-	<ul style="list-style-type: none"> The warning indicator illuminates for 5 minutes. The outer tone alarm will not sound. 	<ul style="list-style-type: none"> IG knob in "LOCK" (OFF) position and push switch OFF are detected. 5 minutes have passed after the warning output started.

Display contents	Message	Item	State	Warning operations		Warning cancellation conditions (Cancels warning operations when one of the conditions met)
				TPMS warning light	Multi information display	
	-	IG knob is not returned properly.	Opening of the driver's door is detected when the IG knob is in ACC or LOCK position and the push switch is ON.	-	<ul style="list-style-type: none"> • The warning indicator illuminates for 5 minutes. • The outer tone alarm will not sound. • Key reminder warning tone alarm sounds until closing of the driver's door is detected. 	<ul style="list-style-type: none"> • The IG knob in the "RUN" or "START" position, or the IG knob in the "LOCK" (OFF) position, and the push switch OFF are detected. • The driver's door is detected closed from the open position. • 5 minutes have passed after the warning output started.

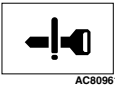
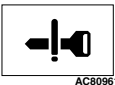
Display contents	Message	Item	State	Warning operations		Warning cancellation conditions (Cancels warning operations when one of the conditions met)
				TPMS warning light	Multi information display	
 <small>AC809615</small>	KEY NOT DETECTED	Keyless operation key take out warning	The keyless operation key is taken out of the car when the IG knob is in other than the LOCK position, and all the doors are closed.	-	<ul style="list-style-type: none"> The warning indicator illuminates for 5 minutes. Outer tone alarm sounds for 5.69 seconds in pattern 2. 	<ul style="list-style-type: none"> IG knob in "LOCK" (OFF) position and push switch OFF are detected. KOS-ECU has detected a keyless operation key inside the vehicle. 5 minutes have passed after the warning output started.

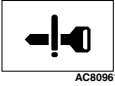
Display contents	Message	Item	State	Warning operations		Warning cancellation conditions (Cancels warning operations when one of the conditions met)
				TPMS warning light	Multi information display	
 AC900961	-	Door lock does not operate.	When the front door outside handle lock switch is turned to ON position while the IG knob is in other than the LOCK position and push switch OFF.	-	<ul style="list-style-type: none"> Warning indicator illuminates for 5 seconds. Outer tone alarm sounds for 2.96 seconds in pattern 1. 	<ul style="list-style-type: none"> IG knob in "LOCK" (OFF) position and push switch OFF are detected. 5 seconds have passed after the warning output started.
 AC809615	KEY STILL IN VEHICLE		When the front door outside handle lock switch is turned to ON position while the keyless operation key is left in the vehicles.			<ul style="list-style-type: none"> Lock switch on the keyless operation switch is pressed again. 5 seconds have passed after the warning output started.
 AC809615	CHECK DOORS		When the front door outside handle lock switch is turned to ON position while the door is ajar.			<ul style="list-style-type: none"> All doors are closed. 5 seconds have passed after the warning output started.

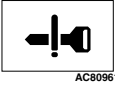
Display contents	Message	Item	State	Warning operations		Warning cancellation conditions (Cancels warning operations when one of the conditions met)
				TPMS warning light	Multi information display	
 <small>AC809615</small>	KEYLESS OPERATION SYSTEM SERVICE REQUIRED	System error	Push switch is pressed ON from OFF when an error has been detected in EEPROM in KOS-ECU.	-	<ul style="list-style-type: none"> The warning indicator illuminates for 5 minutes. The outer tone alarm will not sound. 	5 minutes have passed after the push switch was pressed ON and IG knob is in "LOCK" (OFF) position.
			Push switch is pressed ON from OFF while open circuit in the transmitter antennas are being detected.			
			The push switch is pressed ON from OFF while short circuit in the power supply output (steering lock, transmitter antennas, receiver antenna module, etc.) is detected.			

Display contents	Message	Item		State	Warning operations		Warning cancellation conditions (Cancels warning operations when one of the conditions met)
					TPMS warning light	Multi information display	
 AC809615	KEYLESS OPERATION SYSTEM SERVICE REQUIRED	System error		Steering lock communication error has been detected when the push switch was pressed ON. The IG knob is in other than the LOCK position while some error is being detected.	-	<ul style="list-style-type: none"> The warning indicator illuminates for 5 minutes. The outer tone alarm will not sound. 	5 minutes have passed after the push switch was pressed ON and IG knob is in "LOCK" (OFF) position.
Not displayed	-	TPMS warning light bulb open circuit check		The ignition switch is turned from "LOCK" (OFF) to "ON."	Illuminates for 3 seconds.	-	3 seconds have passed after the TPMS warning light is lit.
 AC809643	LOW TIRE PRESSURE	Tire pressure alarm		The received tire pressure value is under the alarm ON threshold value.	Illuminates.	Symbol and "LOW TIRE PRESSURE" is displayed.	The received tire pressure value is over the alarm OFF threshold value.
 AC809643	TPMS SERVICE REQUIRED	TPMS failure warning	ID not stored	The TPMS transmitter ID is not registered in the KOS-ECU.	Flashes *	Symbol and "SERVICE REQUIRED" is displayed.	ID is registered normally.

Display contents	Message	Item		State	Warning operations		Warning cancellation conditions (Cancels warning operations when one of the conditions met)
					TPMS warning light	Multi information display	
 <small>AC809643</small>	TPMS SERVICE REQUIRED	TPMS failure warning	Defective EEPROM	Abnormality of data in the EEPROM of the KOS-ECU is detected.	Flashes *	Symbol and "SERVICE REQUIRED" is displayed.	Data in the EEPROM of the KOS-ECU is checked to be normal.
			Problem in signal reception	The signals from TPMS transmitters cannot be received while driving for about 20 minutes.			The signal from the TPMS transmitter that was warned is received.
			Defective sensor	The sensor failure signal is received from the TPMS transmitter.			A normal signal is received from the TPMS transmitter that was warned.
			The battery voltage of the TPMS transmitter is low.	The reception problem warning is activated because of the low battery voltage of the TPMS transmitter.			The signal of normal battery voltage is received from the TPMS transmitter that was warned.
			Vehicle speed input problem	The vehicle speed is not input.			The vehicle speed is input.
			Abnormal vehicle speed value	The vehicle speed value is abnormal.			The normal vehicle speed value is received.

NOTE:

- *: Change to continuous illumination after flashing for about 1 minute.
- When the vehicle speed exceeds 30 km/h (18.6 mph) for more than 35 seconds, the signals received from the TPMS transmitter shall be checked for 15 minutes. During that 15 minutes of reception check, when the specified value of a tire is normally received, the tire is judged as the road wheel. After the 15 minutes of measurement, if four tires are judged as the road wheels, the remaining wheel is judged as the spare tire. After the 15 minutes of measurement, if three or less tires are judged as the road wheels, the result of last measurement will be applied for the unjudged tire(s).

<Sound pattern 1>

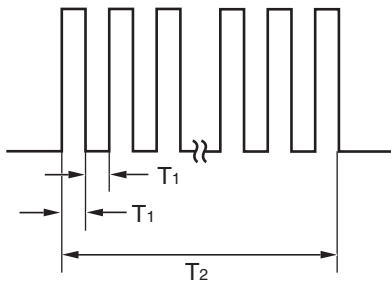

T1 : 0.08 ± 0.01 second
T2 : 2.96 seconds

<Sound pattern 2>

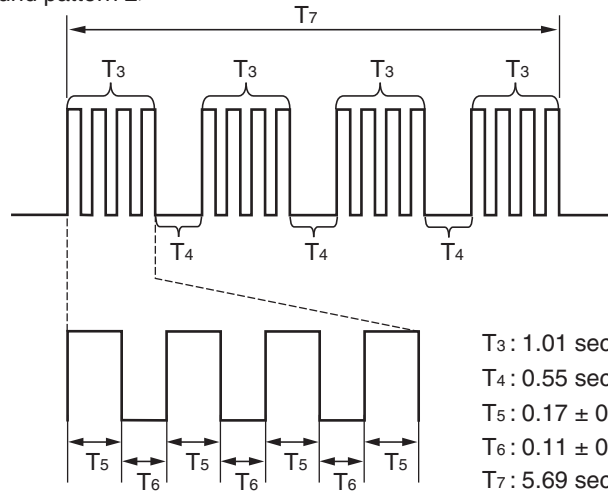

T3 : 1.01 seconds
T4 : 0.55 second
T5 : 0.17 ± 0.01 second
T6 : 0.11 ± 0.01 second
T7 : 5.69 seconds

AC501053AE

DIAGNOSTIC TROUBLE CODE CHART

M1429600200492

⚠ CAUTION

During diagnosis, a DTC associated with other system may be set when the ignition switch is turned on with connector(s) disconnected. On completion, confirm all systems for DTC(s). If DTC(s) are set, erase them all.

DTC No.	Diagnostic item	Reference page
B1731	Engine control module communication timeout	P.42B-25
B1761	VIN code not programmed	P.42B-28
B1A08	Keyless/KOS key1 performance	P.42B-29
B1A09	Keyless/KOS key2 performance	
B1A0A	Keyless/KOS key3 performance	
B1A0B	Keyless/KOS key4 performance	
B1A10	Keyless/KOS key 1 low battery	P.42B-30
B1A11	Keyless/KOS key 2 low battery	
B1A12	Keyless/KOS key 3 low battery	
B1A13	Keyless/KOS key 4 low battery	
B1A24	Key ID not registered	P.42B-31
B1A25	Key ID unmatched	P.42B-32
B1A28	Engine control module authenticate error	P.42B-34
B1A35	Transponder read error	P.42B-36
B2101	IG SW start POS.circuit low	P.42B-39
B2102	IG SW start POS.circuit high	
B2204	Coding data mismatch	P.42B-42
B2206	VIN code mismatch	P.42B-44
B2352	Antenna fail	P.42B-46
B2400	KOS key registration fail	P.42B-51
B2401	Keyless/KOS key ID not registered	P.42B-60
B2402	STL ^{*1} unit comm.(system ID)	P.42B-62
B2403	STL ^{*1} unit comm.(CRC)	
B2404	STL ^{*1} unit comm.(function code)	
B2405	STL ^{*1} unit comm.(rolling code)	
B2406	STL ^{*1} unit comm.(PTC operate)	
B2407	STL ^{*1} unit comm.(EEPROM)	
B2408	STL ^{*1} unit comm.(solenoid)	
B2409	STL ^{*1} unit comm.(No response)	
B240A	DR side antenna(outdoor) open	P.42B-72
B240B	PS side antenna(outdoor) open	P.42B-75
B240C	Tail gate antenna(outdoor) open	P.42B-78

DTC No.	Diagnostic item	Reference page
B240D	Front antenna(indoor) open	P.42B-81
B240E	RR antenna(indoor) open	P.42B-83
B2412	LF antenna power voltage	P.42B-86
B2413	STL ^{*1} unit power voltage	P.42B-90
B2414	Unlock sensor fail	P.42B-93
B2415	RA ^{*2} module power voltage	P.42B-97
B2416	ECU internal error	P.42B-106
C1608	EEPROM error	P.42B-107
C1900	No registration	P.42B-108
C1901	Vehicle speed information abnormality	P.42B-110
C1910	Transmitter low battery voltage abnormality 1	P.42B-112
C1920	Transmitter low battery voltage abnormality 2	
C1930	Transmitter low battery voltage abnormality 3	
C1940	Transmitter low battery voltage abnormality 4	
C1911	Reception abnormality 1	
C1921	Reception abnormality 2	
C1931	Reception abnormality 3	
C1941	Reception abnormality 4	
C1913	Acceleration sensor abnormality 1	P.42B-118
C1923	Acceleration sensor abnormality 2	
C1933	Acceleration sensor abnormality 3	
C1943	Acceleration sensor abnormality 4	
C1914	Pressure sensor abnormality 1	
C1924	Pressure sensor abnormality 2	
C1934	Pressure sensor abnormality 3	
C1944	Pressure sensor abnormality 4	
C1912	Tire inflation pressure warning 1	P.42B-120
C1922	Tire inflation pressure warning 2	
C1932	Tire inflation pressure warning 3	
C1942	Tire inflation pressure warning 4	
C1915	Transmitter OFF mode 1	P.42B-123
C1925	Transmitter OFF mode 2	
C1935	Transmitter OFF mode 3	
C1945	Transmitter OFF mode 4	
U0019	Bus off (CAN-B)	P.42B-124
U0141	ETACS-ECU CAN timeout	P.42B-126
U0151	SRS-ECU CAN timeout	P.42B-128
U0154	Occupant classification-ECU CAN timeout	P.42B-130

DTC No.	Diagnostic item	Reference page
U0155	Combination meter CAN timeout	P.42B-132
U0164	A/C-ECU CAN timeout	P.42B-134
U0184	Audio CAN timeout	P.42B-136
U0195	Satellite radio tuner CAN timeout	P.42B-138
U0197	Hands free module CAN timeout	P.42B-140
U0245	Audio visual navigation unit CAN timeout	P.42B-142
U1412	Implausible vehicle speed signal received	P.42B-144
U1415	Coding not completed/Data fail	P.42B-146
U1417	Implausible coding data	P.42B-147

NOTE:

- *1: STL unit = steering lock unit
- *2: RA module = receiver antenna module

DIAGNOSTIC TROUBLE CODE PROCEDURES

DTC B1731: Engine control module communication timeout

CAUTION

- When the DTC B1731 is set, be sure to diagnose the CAN bus line.
- When replacing the ECU, always check that the communication circuit is normal.

DTC SET CONDITION

KOS-ECU checks that the Engine Control Module data has been received via the CAN bus lines, and if not, sets the DTC No. B1731.

TECHNICAL DESCRIPTION (COMMENT)

If no data [ETACS transmits engine random number data to KOS-ECU via the CAN bus lines] is received from the Engine Control Module via the CAN bus lines when the ignition switch is turned to ON position, it is judged as abnormal.

TROUBLESHOOTING HINTS

- Malfunction of CAN bus line
- Malfunction of KOS-ECU
- Malfunction of ETACS-ECU
- Malfunction of engine control module

DIAGNOSIS

Required Special Tools:

- MB991958: Scan Tool (M.U.T.-III Sub Assembly)
 - MB991824: Vehicles Communication Interface (V.C.I.)
 - MB991827: M.U.T.-III USB Cable
 - MB991910: M.U.T.-III Main Harness A

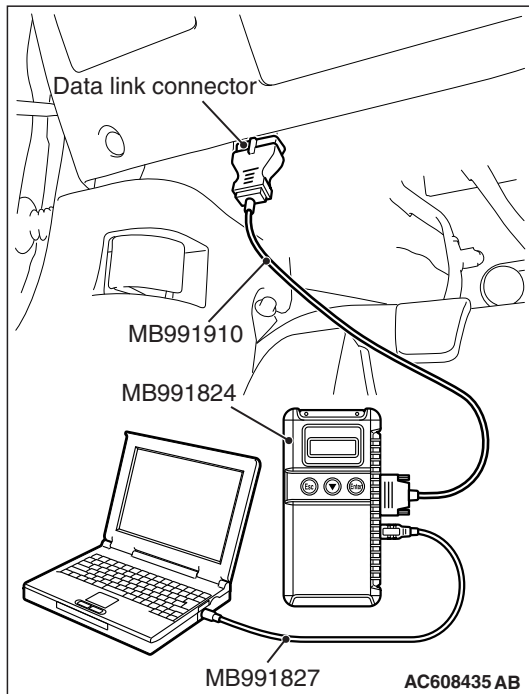

STEP 1. Using scan tool MB991958, diagnose the CAN bus line.

⚠ CAUTION

To prevent damage to scan tool (MB991958), always turn the ignition switch to the "LOCK" (OFF) position before connecting or disconnecting scan tool (MB991958).

- (1) Connect scan tool MB991958 to the data link connector.
- (2) Turn the ignition switch to the "ON" position.
- (3) Diagnose the CAN bus line.
- (4) Turn the ignition switch to the "LOCK" (OFF) position.

Q: Is the CAN bus line found to be normal?

YES : Go to Step 2.

NO : Repair the CAN bus line (Refer to GROUP 54C, Diagnosis [P.54C-15](#)).

STEP 2. Using scan tool MB991958, read the engine control module diagnostic trouble code

Check again if the DTC is set to the engine control module.

Q: Is the DTC set?

YES : Troubleshoot the MFI system (Refer to GROUP 13A, Diagnostic trouble code chart [P.13A-48](#)).

NO : Go to Step 3.

STEP 3. Using scan tool MB991958, read the other system diagnostic trouble code.

Check if DTC U0100 is set to ETACS-ECU.

Q: Is the DTC set?

YES : Go to Step 5.

NO : Go to Step 4.

STEP 4. Recheck for diagnostic trouble code.

Check again if the DTC is set to the KOS-ECU.

- (1) Turn the ignition switch from "LOCK" (OFF) position to "ON" position.
- (2) Check if DTC is set.
- (3) Turn the ignition switch to the "LOCK" (OFF) position.

Q: Is the DTC set?

YES : Replace KOS-ECU and register the ID codes. (Refer to [P.42B-11.](#)) After registering the ID codes, go to Step 6.

NO : The trouble can be an intermittent malfunction (Refer to GROUP 00 –How to use Troubleshooting/inspection Service Points –How to Cope with Intermittent Malfunction [P.00-15](#)).

STEP 5. Recheck for diagnostic trouble code.

Check again if the DTC is set to the KOS-ECU.

- (1) Turn the ignition switch from "LOCK" (OFF) position to "ON" position.
- (2) Check if DTC is set.
- (3) Turn the ignition switch to the "LOCK" (OFF) position.

Q: Is the DTC set?

YES : Replace the engine control module and record the VIN (Refer to GROUP 00 - How To Perform Vehicle Identification Number (VIN) Writing [P.00-22](#)). Then go to Step 6.

NO : The procedure is complete.

STEP 6. Recheck for diagnostic trouble code.

Check again if the DTC is set to the WCM.

- (1) Turn the ignition switch from "LOCK" (OFF) position to "ON" position.
- (2) Check if DTC is set.
- (3) Turn the ignition switch to the "LOCK" (OFF) position.

Q: Is the DTC set?

YES : Replace the ETACS-ECU.

NO : The procedure is complete.

DTC B1761: VIN code not programmed**CAUTION**

- When the DTC No. B1761 is set, be sure to diagnose the CAN bus line.
- When replacing the ECU, always check that the communication circuit is normal.

DTC SET CONDITION

KOS-ECU sets DTC B1761 when no VIN is recorded in it.

TECHNICAL DESCRIPTION (COMMENT)

KOS-ECU determines that the abnormality is present when no VIN is recorded in it.

TROUBLESHOOTING HINTS

- VIN not programmed
- Malfunction of the KOS-ECU

DIAGNOSIS**Required Special Tools:**

- MB991958: Scan Tool (M.U.T.-III Sub Assembly)
 - MB991824: Vehicles Communication Interface (V.C.I.)
 - MB991827: M.U.T.-III USB Cable
 - MB991910: M.U.T.-III Main Harness A

STEP 1. Using scan tool MB991958, diagnose the CAN bus line.**CAUTION**

To prevent damage to scan tool (MB991958), always turn the ignition switch to the "LOCK" (OFF) position before connecting or disconnecting scan tool (MB991958).

- (1) Connect scan tool MB991958 to the data link connector.
- (2) Turn the ignition switch to the "ON" position.
- (3) Diagnose the CAN bus line.
- (4) Turn the ignition switch to the "LOCK" (OFF) position.

Q: Is the CAN bus line found to be normal?

YES : Go to Step 2.

NO : Repair the CAN bus line (Refer to GROUP 54C, Diagnosis P.54C-15).

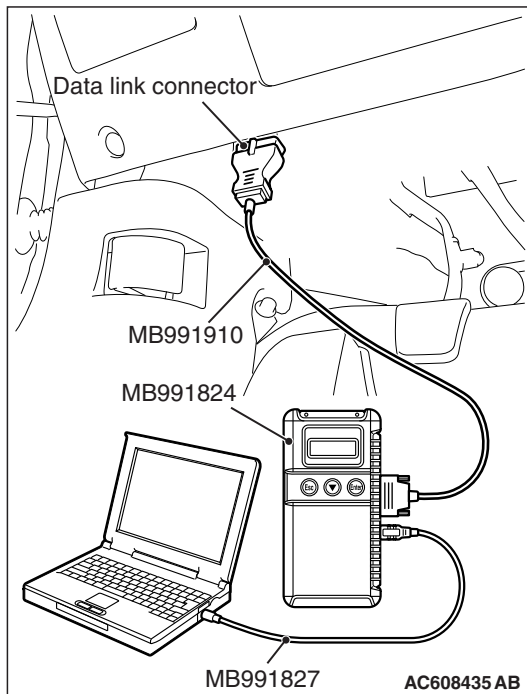

STEP 2. Register the VIN and recheck the diagnostic trouble code.

Register VIN in KOS-ECU (Refer to GROUP 00 –How to Perform Vehicle Identification Number (VIN) Writing P.00-22) and recheck if the DTC is set.

- (1) Turn the ignition switch from the "LOCK" (OFF) position to the "ON" position.
- (2) Check if DTC is set.
- (3) Turn the ignition switch to the "LOCK" (OFF) position.

Q: Is the DTC set?

YES : Replace KOS-ECU and register the ID codes (Refer to P.42B-11).

NO : The procedure is complete.

- DTC B1A08: Keyless/KOS key1 performance
- DTC B1A09: Keyless/KOS key2 performance
- DTC B1A0A: Keyless/KOS key3 performance
- DTC B1A0B: Keyless/KOS key4 performance

CAUTION

When replacing the ECU, always check that the communication circuit is normal.

DTC SET CONDITION

The mechanism which automatically changes a code for lock/unlock each time a lock operation is performed is referred to as a rolling code. If KOS-ECU receives wrong signal (out of synchronization of a rolling code) from the keyless operation key, KOS-ECU memorizes DTC B1A08.

TECHNICAL DESCRIPTION (COMMENT)

- B1A08: If the difference between the rolling code for the keyless operation key 1 (the first keyless operation key registered with KOS-ECU) and that memorized by KOS-ECU is large, it is judged as abnormal.
- B1A09: If the difference between the rolling code for the keyless operation key 2 (the second keyless operation key registered with KOS-ECU) and that memorized by KOS-ECU is large, it is judged as abnormal.
- B1A0A: If the difference between the rolling code for the keyless operation key 3 (the third keyless operation key registered with KOS-ECU) and that memorized by KOS-ECU is large, it is judged as abnormal.

- B1A0B: If the difference between the rolling code for the keyless operation key 4 (the fourth keyless operation key registered with KOS-ECU) and that memorized by KOS-ECU is large, it is judged as abnormal.

TROUBLESHOOTING HINTS

- Rolling code out of synchronization
- Malfunction of the keyless operation key
- Malfunction of the KOS-ECU

DIAGNOSIS

STEP 1. Synchronize the rolling code and recheck the diagnostic trouble code.

Synchronize the rolling codes, and check whether the DTC is reset.

- (1) Erase the DTC.
- (2) Turn the ignition switch from the LOCK (OFF) position to the ON position.
- (3) Press the lock or unlock switch of the keyless operation key for which the diagnosis code is set at least once to synchronize the rolling codes.
- (4) Check if the DTC is set.

Q: Is the DTC set?

YES : Go to Step 2.

NO : The diagnosis is complete.

STEP 2. Check whether the diagnostic trouble code is reset.

Replace the keyless operation key for which the DTC is set with a new one, register the key ID and keyless operation key ID (refer to [P.42B-227](#)), and check whether the DTC is reset.

- (1) Erase the DTC.
- (2) Turn the ignition switch from the LOCK (OFF) position to the ON position.
- (3) Check if the DTC is set.

Q: Is the DTC set?

YES : Replace KOS-ECU and register the ID codes (Refer to [P.42B-11](#)).

NO : The diagnosis is complete.

DTC B1A10: Keyless/KOS key 1 low battery

DTC B1A11: Keyless/KOS key 2 low battery

DTC B1A12: Keyless/KOS key 3 low battery

DTC B1A13: Keyless/KOS key 4 low battery

⚠ CAUTION

When replacing the ECU, always check that the communication circuit is normal.

DIAGNOSTIC FUNCTION

If KOS-ECU receives the keyless operation key low battery voltage signal, KOS-ECU sets the DTC No. B1A10, B1A11, B1A12, or B1A13.

JUDGEMENT CRITERIA

- B1A10: If KOS-ECU receives the keyless operation key 1 (the first keyless operation key registered with KOS-ECU) low battery voltage signal in five consecutive times, it is judged as abnormal.
- B1A11: If KOS-ECU receives the keyless operation key 2 (the second keyless operation key registered with KOS-ECU) low battery voltage signal in five consecutive times, it is judged as abnormal.
- B1A12: If KOS-ECU receives the keyless operation key 3 (the third keyless operation key registered with KOS-ECU) low battery voltage signal in five consecutive times, it is judged as abnormal.
- B1A13: If KOS-ECU receives the keyless operation key 4 (the fourth keyless operation key registered with KOS-ECU) low battery voltage signal in five consecutive times, it is judged as abnormal.

PROBABLE CAUSES

- Malfunction of the keyless operation key battery
- Malfunction of the keyless operation key
- Malfunction of KOS-ECU

DIAGNOSTIC PROCEDURE**STEP 1. Replace the battery in the keyless operation key and recheck the diagnostic trouble code.**

Replace the battery of the keyless operation key for which the DTC is set, and check whether the DTC is reset.

- (1) Replace the battery of the keyless operation key for which the DTC is set.
- (2) Erase the DTC.
- (3) Turn the ignition switch from the LOCK (OFF) position to the ON position.
- (4) Lock or unlock the keyless operation key.
- (5) Check if the DTC is set.

Q: Is the DTC set?

YES : Go to Step 2.

NO : The diagnosis is complete (Discharged battery).

STEP 2. Replace the keyless operation key and recheck the diagnostic trouble code.

Replace the keyless operation key for which the DTC is set with a new one, register the key ID and keyless operation key ID (refer to [P.42B-227](#)), and check whether the DTC is reset.

- (1) Erase the DTC.
- (2) Turn the ignition switch from the LOCK (OFF) position to the ON position.
- (3) Check if the DTC is set.

Q: Is the DTC set?

YES : Replace KOS-ECU and register the ID codes (Refer to [P.42B-11](#)).

NO : The diagnosis is complete.

DTC B1A24: Key ID not registered

CAUTION

- When the DTC B1A24 is set, be sure to diagnose the CAN bus line.
- When replacing the ECU, always check that the communication circuit is normal.

DTC SET CONDITION

KOS-ECU sets DTC B1A24 when the key ID was not registered in it.

TECHNICAL DESCRIPTION (COMMENT)

KOS-ECU determines that the abnormality is present, if the key ID is not registered in it when the ignition switch is turned ON.

TROUBLESHOOTING HINTS

- Key ID not registered
- Malfunction of the keyless operation key
- Malfunction of KOS-ECU

DIAGNOSIS

Required Special Tools:

- MB991958: Scan Tool (M.U.T.-III Sub Assembly)
 - MB991824: Vehicles Communication Interface (V.C.I.)
 - MB991827: M.U.T.-III USB Cable
 - MB991910: M.U.T.-III Main Harness A

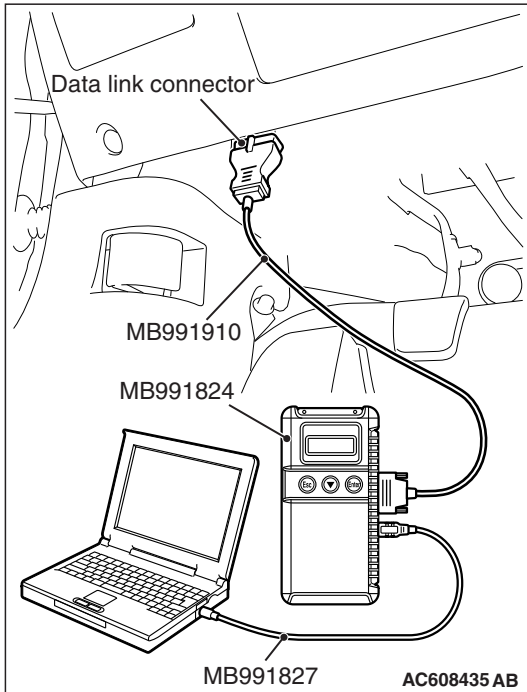

STEP 1. Using scan tool MB991958, diagnose the CAN bus line.

⚠ CAUTION

To prevent damage to scan tool (MB991958), always turn the ignition switch to the "LOCK" (OFF) position before connecting or disconnecting scan tool (MB991958).

- (1) Connect scan tool MB991958 to the data link connector.
- (2) Turn the ignition switch to the "ON" position.
- (3) Diagnose the CAN bus line.
- (4) Turn the ignition switch to the "LOCK" (OFF) position.

Q: Is the CAN bus line found to be normal?

YES : Go to Step 2.

NO : Repair the CAN bus line (Refer to GROUP 54C, Diagnosis [P.54C-15](#)).

STEP 2. Register the key ID and recheck the diagnostic trouble code.

Register the key ID and keyless operation key ID of the keyless operation key by which the DTC is set (refer to [P.42B-11](#)), and recheck if the DTC is set.

- (1) Turn the ignition switch from the "LOCK" (OFF) position to the "ON" position.
- (2) Check if the DTC is set.

Q: Is the DTC set?

YES : Replace KOS-ECU and register the ID codes (Refer to [P.42B-11](#)).

NO : The procedure is complete.

DTC B1A25: Key ID unmatched

⚠ CAUTION

- When the DTC B1A25 is set, be sure to diagnose the CAN bus line.
- When replacing the ECU, always check that the communication circuit is normal.

DTC SET CONDITION

KOS-ECU sets DTC B1A25 when the received key ID is different from the one registered in it.

TECHNICAL DESCRIPTION (COMMENT)

KOS-ECU determines that the abnormality is present, if the key ID does not match the one registered in it when the ignition switch is turned ON.

TROUBLESHOOTING HINTS

- Malfunction of the keyless operation key
- Accessory key not registered
- Accessory KOS-ECU not registered
- Key is registered to another vehicle
- Malfunction of KOS-ECU

DIAGNOSIS

Required Special Tools:

- MB991958: Scan Tool (M.U.T.-III Sub Assembly)
 - MB991824: Vehicles Communication Interface (V.C.I.)
 - MB991827: M.U.T.-III USB Cable
 - MB991910: M.U.T.-III Main Harness A

STEP 1. Using scan tool MB991958, diagnose the CAN bus line.

⚠ CAUTION

To prevent damage to scan tool (MB991958), always turn the ignition switch to the "LOCK" (OFF) position before connecting or disconnecting scan tool (MB991958).

- (1) Connect scan tool MB991958 to the data link connector.
- (2) Turn the ignition switch to the "ON" position.
- (3) Diagnose the CAN bus line.
- (4) Turn the ignition switch to the "LOCK" (OFF) position.

Q: Is the CAN bus line found to be normal?

YES : Go to Step 2.

NO : Repair the CAN bus line (Refer to GROUP 54C, Diagnosis [P.54C-15](#)).

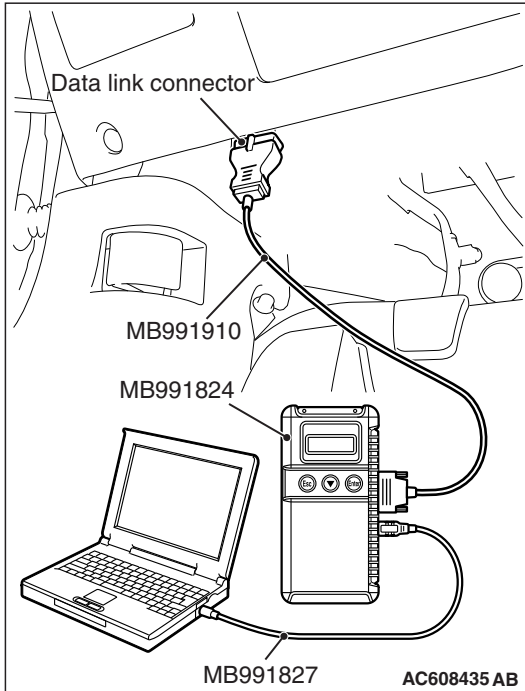

STEP 2. Register the key ID and recheck the diagnostic trouble code.

Register the key ID and keyless operation key ID of the keyless operation key by which the DTC is set (refer to [P.42B-11](#)), and recheck if the DTC is set.

- (1) Turn the ignition switch from the "LOCK" (OFF) position to the "ON" position.
- (2) Check if the DTC is set.

Q: Is the DTC set?

YES : Go to Step 3.

NO : The procedure is complete.

STEP 3. Replace the keyless operation key and recheck the diagnostic trouble code.

Replace the keyless operation key for which the DTC is set with the other key, and check whether the DTC is reset.

(1) Turn the ignition switch from the "LOCK" (OFF) position to the "ON" position.

(2) Check if the DTC is set.

Q: Is the DTC set?

YES : Go to Step 4.

NO : Go to Step 5.

STEP 4. Register the key ID and recheck the diagnostic trouble code.

Register the key ID and keyless operation key ID of the keyless operation key by which the DTC is set (refer to [P.42B-11](#)), and recheck if the DTC is set.

(1) Turn the ignition switch from the "LOCK" (OFF) position to the "ON" position.

(2) Check if the DTC is set.

Q: Is the DTC set?

YES : Go to Step 5.

NO : The procedure is complete.

STEP 5. Replace the keyless operation key and recheck the diagnostic trouble code.

Replace the keyless operation key for which the DTC is set with a new one, register the key ID and keyless operation key ID (refer to [P.42B-11](#)), and check whether the DTC is reset.

(1) Turn the ignition switch from the "LOCK" (OFF) position to the "ON" position.

(2) Check if the DTC is set.

Q: Is the DTC set?

YES : Replace KOS-ECU and register the ID codes (Refer to [P.42B-11](#)).

NO : The procedure is complete.

DTC B1A28: Engine control module authenticate error**CAUTION**

- When DTC B1A28 is set, be sure to diagnose the CAN bus line.
- When replacing the ECU, always check that the communication circuit is normal.

DTC SET CONDITION

If the key certification result by KOS-ECU does not match with the engine control module status, KOS-ECU sets DTC B1A28.

TECHNICAL DESCRIPTION (COMMENT)

KOS-ECU determines that the abnormality is present, if the key certification result and the engine control module status do not match after the engine start permission communication is completed.

TROUBLESHOOTING HINTS

- Malfunction of CAN bus line
- Malfunction of KOS-ECU
- Malfunction of engine control module
- VIN registered in engine control module unmatched

DIAGNOSIS

Required Special Tools:

- MB991958 Scan Tool (M.U.T.-III Sub Assembly)
 - MB991824: Vehicles Communication Interface (V.C.I.)
 - MB991827 M.U.T.-III USB Cable
 - MB991910 M.U.T.-III Main Harness A

STEP 1. Using scan tool MB991958, diagnose the CAN bus line.

⚠ CAUTION

To prevent damage to scan tool (MB991958), always turn the ignition switch to the "LOCK" (OFF) position before connecting or disconnecting scan tool (MB991958).

- (1) Connect scan tool MB991958 to the data link connector.
- (2) Turn the ignition switch to the "ON" position.
- (3) Diagnose the CAN bus line.
- (4) Turn the ignition switch to the "LOCK" (OFF) position.

Q: Is the CAN bus line found to be normal?

YES : Go to Step 2.

NO : Repair the CAN bus line (Refer to GROUP 54C, Diagnosis [P.54C-15](#)).

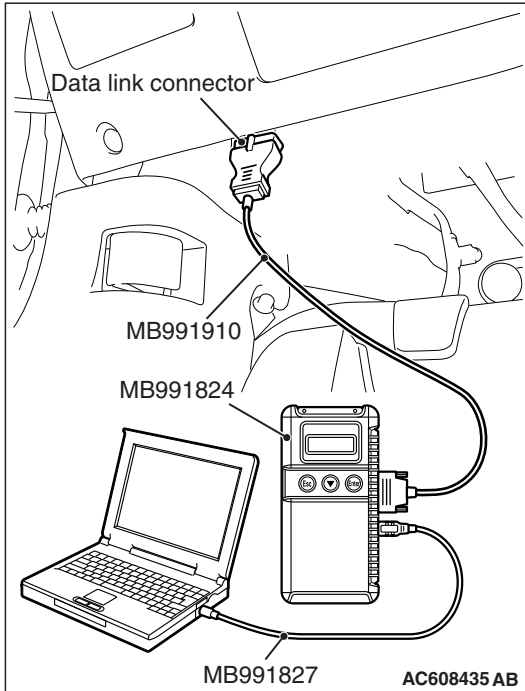

STEP 2. Using scan tool MB991958, read the engine control module diagnostic trouble code.

Check again if the DTC is set to the engine control module.

Q: Is the DTC set?

YES : Troubleshoot the MFI system (Refer to GROUP 13A, Diagnostic trouble code chart [P.13A-48](#)).

NO : Go to Step 3.

STEP 3. Using scan tool MB991958, read the diagnostic trouble code.

Check if the DTC is set to the KOS-ECU.

- (1) Turn the ignition switch from the "LOCK" (OFF) position to the "ON" position.
- (2) Check if the DTC is set.

Q: Is DTC B1761 or B2206 set other than B1A28?

YES : Perform the troubleshooting for each DTC. Refer to [P.42B-28](#) <B1761> and [P.42B-44](#) <B2206>.

NO : Go to Step 4.

STEP 4. Recheck for diagnostic trouble code.

Check again if the DTC is set to the KOS-ECU.

- (1) Turn the ignition switch from the "LOCK" (OFF) position to the "ON" position.
- (2) Check if the DTC is set.

Q: Is the DTC set?

YES : Replace KOS-ECU and register the ID codes (Refer to P.42B-11). Then go to Step 5.

NO : The diagnosis is complete.

STEP 5. Recheck for diagnostic trouble code.

Check again if the DTC is set to the KOS-ECU.

- (1) Turn the ignition switch from the "LOCK" (OFF) position to the "ON" position.
- (2) Check if the DTC is set.

Q: Is the DTC set?

YES : Replace the engine control module and record VIN (Refer to GROUP 00 –How to Perform Vehicle Identification Number (VIN) Writing P.00-22).

NO : The procedure is complete.

DTC B1A35: Transponder read error**CAUTION**

- When DTC B1A35 is set, be sure to diagnose the CAN bus line.
- When replacing the ECU, always check that the communication circuit is normal.

DTC SET CONDITION

If no transponder data can be received, KOS-ECU sets DTC B1A35.

TECHNICAL DESCRIPTION (COMMENT)

KOS-ECU determines that the abnormality is present, if it cannot receive the key ID for the keyless operation key when the ignition switch is turned ON.

TROUBLESHOOTING HINTS

- Insufficient inverse insertion of keyless operation key at the emergency operation
- Malfunction of CAN bus line
- Malfunction of the keyless operation key
- Interference of the key ID
- Malfunction of KOS-ECU
- Ignition switch ON by the emergency key only

DIAGNOSIS**Required Special Tools:**

- MB991958: Scan Tool (M.U.T.-III Sub Assembly)
 - MB991824: Vehicles Communication Interface (V.C.I.)
 - MB991827: M.U.T.-III USB Cable
 - MB991910: M.U.T.-III Main Harness A

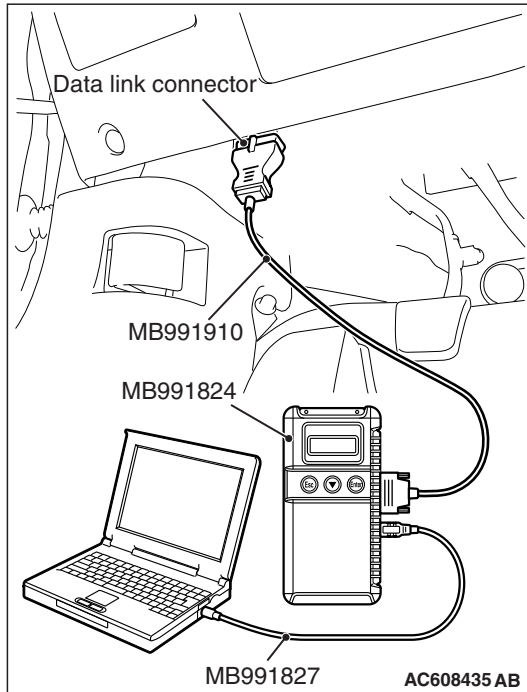

STEP 1. Sufficiently insert the keyless operation key in the inverted direction at the emergency operation, and recheck the diagnostic trouble code.

With the emergency operation by the sufficient inverse insertion of keyless operation key, recheck if the DTC is set.

⚠ CAUTION

To prevent damage to scan tool (MB991958), always turn the ignition switch to the "LOCK" (OFF) position before connecting or disconnecting scan tool (MB991958).

- (1) Connect scan tool MB991958 to the data link connector.
- (2) With the emergency operation by the sufficient inverse insertion of keyless operation key, turn the ignition switch from the LOCK (OFF) position to the ON position.
- (3) Check if DTC is set.
- (4) Turn the ignition switch to the "LOCK" (OFF) position.

Q: Is the DTC set?

YES : Go to Step 2.

NO : The procedure is complete.

STEP 2. Using scan tool MB991958, diagnose the CAN bus line.

- (1) Turn the ignition switch to the "ON" position.
- (2) Diagnose the CAN bus line.
- (3) Turn the ignition switch to the "LOCK" (OFF) position.

Q: Is the CAN bus line found to be normal?

YES : Go to Step 3.

NO : Repair the CAN bus line (Refer to GROUP 54C, Diagnosis [P.54C-15](#)).

STEP 3. Check the emergency key and keyless operation key inserted in the key cylinder for interference.

Check if there are other keys or anything that interferes with the communication (things that generate radio waves such as magnets and an air-cleaning device that has a power plug) near the key inserted in the key cylinder.

Q: Are there other keys or anything that interferes with the communication?

YES : Move away or remove other keys or anything that interferes with the communication, and go to Step 4.

NO : Go to Step 5.

STEP 4. Recheck for diagnostic trouble code.

Check again if the DTC is set to the KOS-ECU.

- (1) Turn the ignition switch from "LOCK" (OFF) position to "ON" position.
- (2) Check if DTC is set.
- (3) Turn the ignition switch to the "LOCK" (OFF) position.

Q: Is the DTC set?

YES : Go to Step 5.

NO : The trouble can be an intermittent malfunction (Refer to GROUP 00 –How to use Troubleshooting/inspection Service Points –How to Cope with Intermittent Malfunction [P.00-15](#)).

STEP 5. Replace the keyless operation key and recheck the diagnostic trouble code.

Replace the keyless operation key for which the DTC is set with the other key, and check whether the DTC is reset.

- (1) Turn the ignition switch from the "LOCK" (OFF) position to the "ON" position.
- (2) Check if the DTC is set.

Q: Is the DTC set?

YES : Go to Step 6.

NO : Go to Step 7.

STEP 6. Register the key ID and recheck the diagnostic trouble code.

Register the key ID and keyless operation key ID of the keyless operation key by which the DTC is set (refer to [P.42B-11](#)), and recheck if the DTC is set.

- (1) Turn the ignition switch from the "LOCK" (OFF) position to the "ON" position.
- (2) Check if the DTC is set.

Q: Is the DTC set?

YES : Go to Step 7.

NO : The procedure is complete.

STEP 7. Replace the keyless operation key and recheck the diagnostic trouble code.

Replace the keyless operation key for which the DTC is set with a new one, register the key ID and keyless operation key ID (refer to [P.42B-11](#)), and check whether the DTC is reset.

- (1) Turn the ignition switch from the "LOCK" (OFF) position to the "ON" position.
- (2) Check if the DTC is set.

Q: Is the DTC set?

YES : Replace KOS-ECU and register the ID codes (Refer to [P.42B-11](#)).

NO : The procedure is complete.

DTC B2101: IG SW start POS.circuit low
DTC B2102: IG SW start POS.circuit high

CAUTION

- If DTC B2101 or B2102 is set in KOS-ECU, always diagnose the CAN bus lines.
- Before replacing the ECU, ensure that the communication circuit is normal.

KOS-ECU Communication Circuit

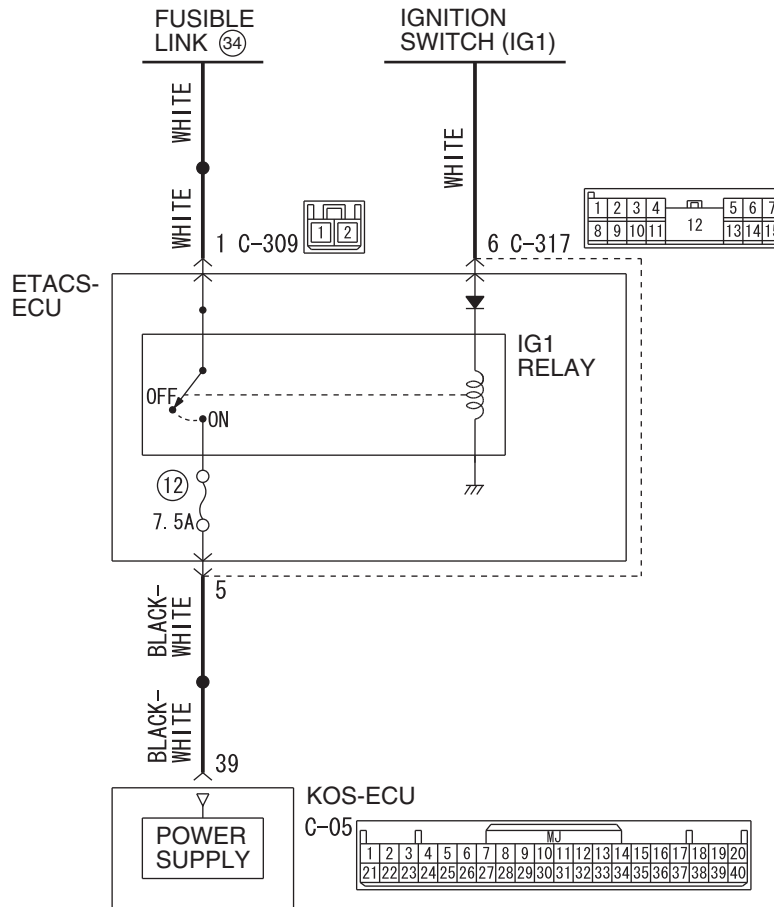

W8H42M000A

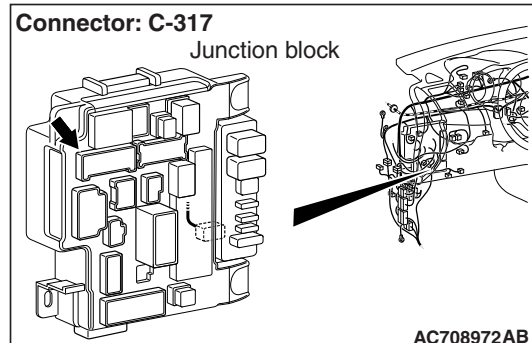
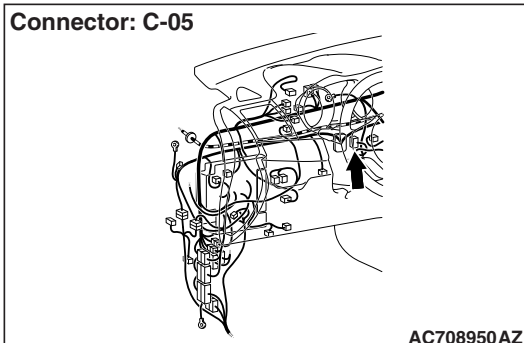

DTC SET CONDITION

If the actual ignition switch status is different from the ignition switch status information received from ETACS-ECU via CAN, KOS-ECU sets diagnostic trouble code No. B2101 or B2102.

TECHNICAL DESCRIPTION (COMMENT)

If the difference in the ignition switch level shown below occurs consecutively 10 times with the ignition switch in the ON position or START position, when the CAN message (ignition switch position information) from ETACS-ECU, KOS-ECU determines that there is a problem.

B2101

- Status of ignition switch: OFF position
- Ignition switch position information: ON

B2102

- Status of ignition switch: ON position
- Ignition switch position information: OFF

TROUBLESHOOTING HINTS

- Malfunction of CAN bus line
- Malfunction of the KOS-ECU
- Malfunction of the ignition switch
- Damaged wiring harness and connectors
- Malfunction of ETACS-ECU

DIAGNOSIS**Required Special Tools:**

- MB991958: Scan Tool (M.U.T.-III Sub Assembly)
 - MB991824: Vehicles Communication Interface (V.C.I.)
 - MB991827: M.U.T.-III USB Cable
 - MB991910: M.U.T.-III Main Harness A

STEP 1. Using scan tool MB991958, diagnose the CAN bus line.

⚠ CAUTION

To prevent damage to scan tool (MB991958), always turn the ignition switch to the "LOCK" (OFF) position before connecting or disconnecting scan tool (MB991958).

- (1) Connect scan tool MB991958 to the data link connector.
- (2) Turn the ignition switch to the "ON" position.
- (3) Diagnose the CAN bus line.
- (4) Turn the ignition switch to the "LOCK" (OFF) position.

Q: Is the CAN bus line found to be normal?

YES : Go to Step 2.

NO : Repair the CAN bus line (Refer to GROUP 54C, Diagnosis [P.54C-15](#)).

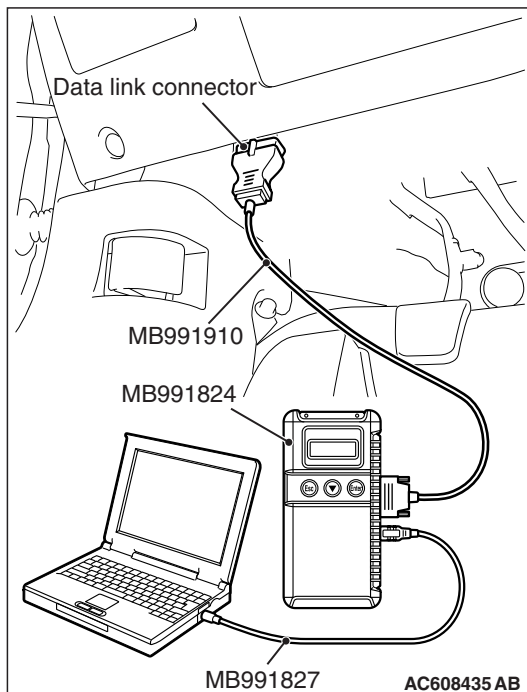

STEP 2. Check ETACS-ECU connector C-317 and KOS-ECU connector C-05 for loose, corroded or damaged terminals, or terminals pushed back in the connector.

Q: Is ETACS-ECU connector C-317 and KOS-ECU connector C-05 in good condition?

YES : Go to Step 3.

NO : Repair the defective connector.

STEP 3. Check the wiring harness between KOS-ECU connector C-05 (terminal No.39) and ETACS-ECU connector C-317 (terminal No.5) for open circuit.

(1) Disconnect KOS-ECU connector C-05 and ETACS-ECU connector C-317, and check the wiring harness.

(2) Check the wiring harness between KOS-ECU connector C-05 (terminal No.39) and ETACS-ECU connector C-317 (terminal No.5)

OK: Continuity exists (2 Ω or less)

Q: Is the wiring harness between KOS-ECU connector C-05 (terminal No. 39) and ETACS-ECU connector C-317 (terminal No. 5) in good condition?

YES : Go to Step 4.

NO : Repair the wiring harness between KOS-ECU connector C-05 (terminal No.39) and ETACS-ECU connector C-317 (terminal No.5).

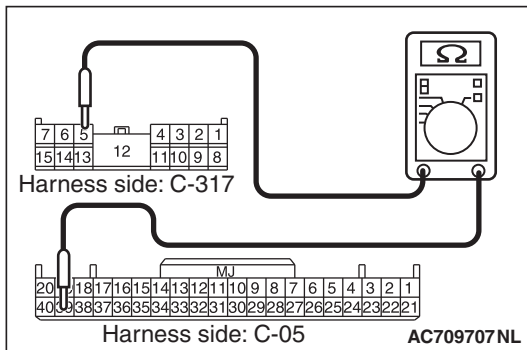

STEP 4. Using scan tool MB991958, check data list.

Use the ETACS-ECU data list to check the signals related to the ignition voltage.

(1) Turn the ignition switch from "LOCK" (OFF) position to "ON" position.

Item No.	Item name	Normal conditions
Item 254	IG voltage	Battery positive voltage

Q: Does scan tool MB991958 display the item "IG voltage" as normal condition?

YES : Go to Step 5.

NO : Diagnose the ETACS-ECU (Refer to GROUP 54A – ETACS, Diagnosis [P.54A-646](#)).

STEP 5. Recheck for diagnostic trouble code.

Check again if the DTC is set to the KOS-ECU.

- (1) Erase the DTC.
- (2) Turn the ignition switch from "LOCK" (OFF) position to "ON" position.
- (3) Check if DTC is set.
- (4) Turn the ignition switch to the "LOCK" (OFF) position.

Q: Is the DTC set?

YES : Replace KOS-ECU and register the ID codes (Refer to [P.42B-11](#)).

NO : The trouble can be an intermittent malfunction (Refer to GROUP 00 –How to use Troubleshooting/inspection Service Points –How to Cope with Intermittent Malfunction [P.00-15](#)).

DTC B2204: Coding data mismatch**⚠ CAUTION**

- When DTC B2204 is set, be sure to diagnose the CAN bus line.
- When replacing the ECU, always check that the communication circuit is normal.

DTC SET CONDITION

If the vehicle information data transmitted from the ETACS-ECU via the CAN bus lines is different from that registered in the KOS-ECU, the KOS-ECU sets DTC No. B2204.

TECHNICAL DESCRIPTION (COMMENT)

KOS-ECU determines that the abnormality is present when the vehicle information registered in it does not match the vehicle information on the CAN bus lines.

TROUBLESHOOTING HINTS

- Malfunction of CAN bus line
- Malfunction of KOS-ECU
- Malfunction of ETACS-ECU

DIAGNOSIS**Required Special Tools:**

- MB991958 Scan Tool (M.U.T.-III Sub Assembly)
 - MB991824: Vehicles Communication Interface (V.C.I.)
 - MB991827 M.U.T.-III USB Cable
 - MB991910 M.U.T.-III Main Harness A

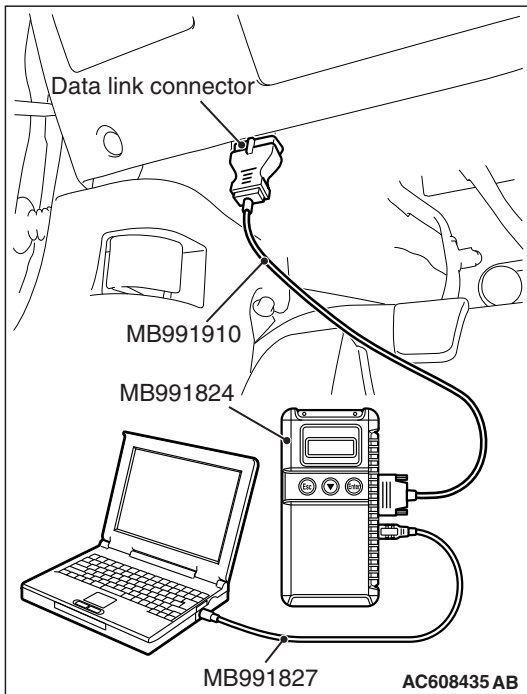

STEP 1. Using scan tool MB991958, diagnose the CAN bus line.

⚠ CAUTION

To prevent damage to scan tool (MB991958), always turn the ignition switch to the "LOCK" (OFF) position before connecting or disconnecting scan tool (MB991958).

- (1) Connect scan tool MB991958 to the data link connector.
- (2) Turn the ignition switch to the "ON" position.
- (3) Diagnose the CAN bus line.
- (4) Turn the ignition switch to the "LOCK" (OFF) position.

Q: Is the CAN bus line found to be normal?

YES : Go to Step 2.

NO : Repair the CAN bus line (Refer to GROUP 54C, Diagnosis [P.54C-15](#)).

STEP 2. Using scan tool MB991958, read the ETACS-ECU diagnostic trouble code

Check if a coding-related DTC is set in the ETACS-ECU.

Q: Is the DTC set?

YES : Troubleshoot the ETACS (Refer to GROUP 54A – ETACS, Diagnosis [P.54A-646](#)).

NO : Go to Step 3.

STEP 3. Recheck for diagnostic trouble code.

Check again if the DTC is set to the WCM.

- (1) Erase the DTC.
- (2) Turn the ignition switch from "LOCK" (OFF) position to "ON" position.
- (3) Check if DTC is set.
- (4) Turn the ignition switch to the "LOCK" (OFF) position.

Q: Is the DTC set?

YES : Replace KOS-ECU and register the ID codes (Refer to [P.42B-11](#)).

NO : The trouble can be an intermittent malfunction (Refer to GROUP 00 –How to use Troubleshooting/inspection Service Points –How to Cope with Intermittent Malfunction [P.00-15](#)).

DTC B2206: VIN code mismatch

DTC SET CONDITION

KOS-ECU sets DTC B2206 when VIN registered in it and VIN that has been transmitted on the CAN bus do not match.

TECHNICAL DESCRIPTION (COMMENT)

KOS-ECU determines that the abnormality is present when VIN registered in it and the one that has been transmitted on the CAN bus do not match.

TROUBLESHOOTING HINTS

- Malfunction of KOS-ECU (KOS-ECU being registered to another vehicle)
- Malfunction of ECM (VIN registered in ECM unmatched)

DIAGNOSIS**Required Special Tools:**

- MB991958 Scan Tool (M.U.T.-III Sub Assembly)
 - MB991824: Vehicles Communication Interface (V.C.I.)
 - MB991827 M.U.T.-III USB Cable
 - MB991910 M.U.T.-III Main Harness A

STEP 1. Check the VIN registered in the engine control module and the VIN of the vehicle.

Check if the VIN registered in the engine control module matches with the VIN of the vehicle.

- (1) On the system selection screen of the scan tool, select "MFI/GDI/Diesel".
- (2) Select "Coding."
- (3) Select "VIN Information."
- (4) Compare with the VIN of the vehicle.

Q: Does the VIN of the engine control module match with the VIN of the vehicle?

YES : Go to Step 2.

NO : Write the VIN to the engine control module. [Refer to GROUP 00 –How to Perform Vehicle Identification Number (VIN) Writing [P.00-22](#)]. Record VIN and go to Step 2.

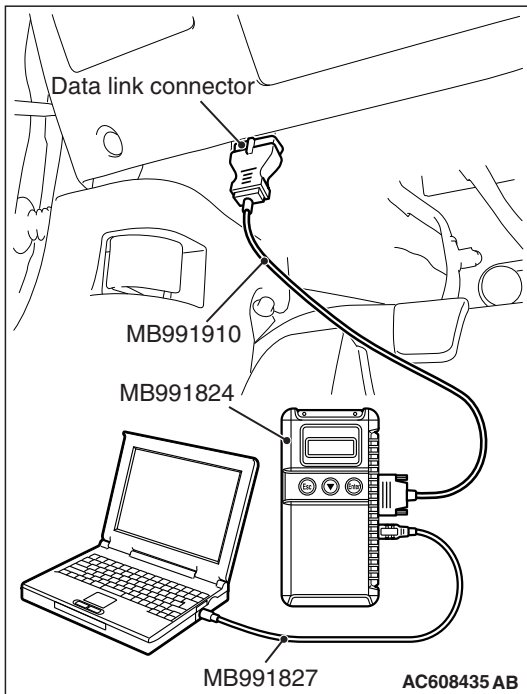

STEP 2. Recheck for diagnostic trouble code.

Check again if the DTC is set to the KOS-ECU.

⚠ CAUTION

To prevent damage to scan tool (MB991958), always turn the ignition switch to the "LOCK" (OFF) position before connecting or disconnecting scan tool (MB991958).

- (1) Connect scan tool MB991958 to the data link connector.
- (2) Turn the ignition switch to the "ON" position.
- (3) Check if the DTC is set.

Q: Is the DTC set?

YES : Replace KOS-ECU and register the ID codes (Refer to P.42B-11). After registering the ID codes, go to Step 3.

NO : The procedure is complete.

STEP 3. Recheck for diagnostic trouble code.

Check again if the DTC is set to the KOS-ECU.

- (1) Turn the ignition switch to the "ON" position.
- (2) Check if the DTC is set.

Q: Is the DTC set?

YES : Replace the engine control module and record the VIN [Refer to GROUP 00 –How To Perform Vehicle Identification Number (VIN) Writing P.00-22].

NO : The procedure is complete.

DTC B2352: Antenna fail

CAUTION

When replacing the ECU, always check that the communication circuit is normal.

Receiver Antenna Module and KOS-ECU Circuit

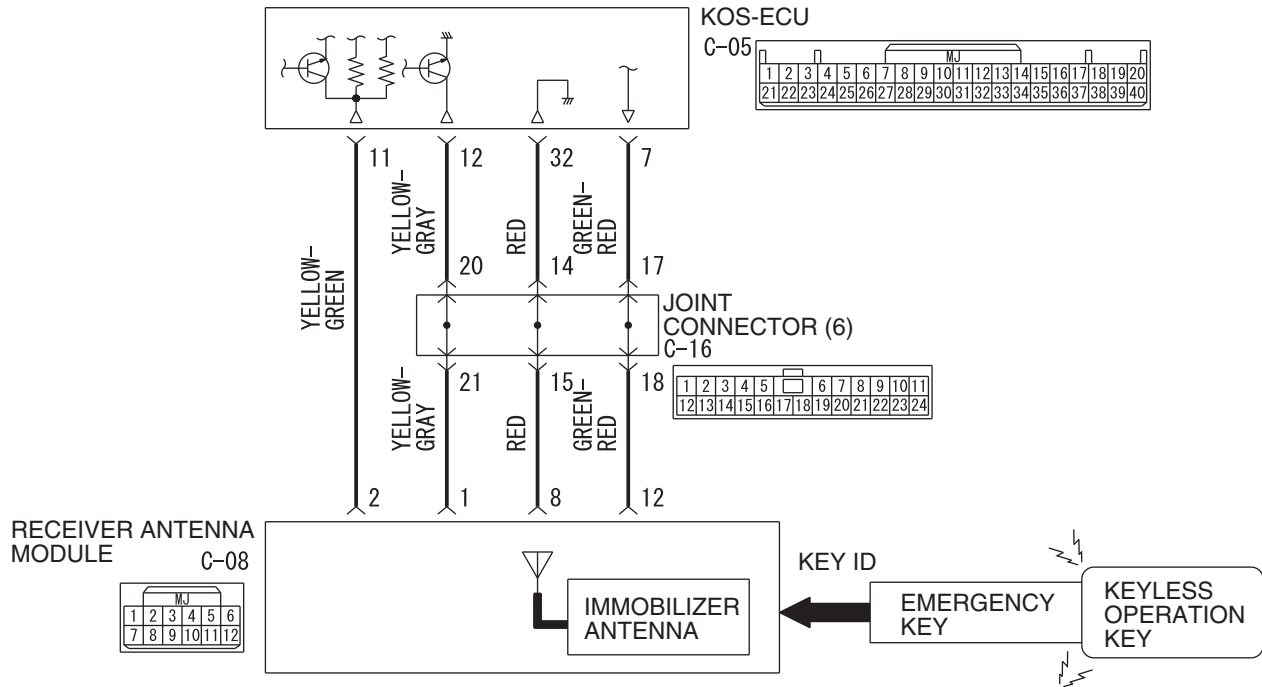

W8H42M002A

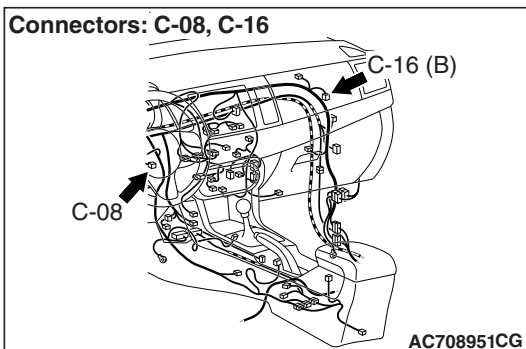
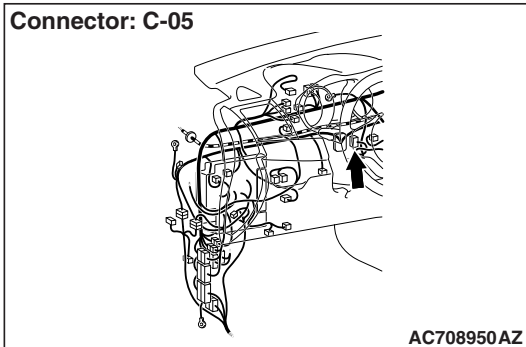

DTC SET CONDITION

If an open circuit or short to ground occurs in the antenna, KOS-ECU sets DTC B2352.

TECHNICAL DESCRIPTION (COMMENT)

When the ignition switch is turned ON with the emergency operation by the inversely-inserted keyless operation key, KOS-ECU sends signals to the receiver antenna module. The receiver antenna transmits random numbers to the keyless operation key when it receives signals from KOS-ECU. If an open circuit or short to ground occurs on the wiring harness between KOS-ECU and receiver antenna at this time, KOS-ECU determines that there is a problem.

TROUBLESHOOTING HINTS

- Malfunction of the receiver antenna module
- Damaged wiring harness and connectors
- Malfunction of KOS-ECU

DIAGNOSIS

Required Special Tools:

- MB991958: Scan Tool (M.U.T.-III Sub Assembly)
 - MB991824: Vehicles Communication Interface (V.C.I.)
 - MB991827: M.U.T.-III USB Cable
 - MB991910: M.U.T.-III Main Harness A

STEP 1. Check receiver antenna module connector C-08, KOS-ECU connector C-05 and joint connector (6) C-16 for loose, corroded or damaged terminals, or terminals pushed back in the connector.

Q: Is the receiver antenna module connector C-08, KOS-ECU connector C-05 and joint connector (6) C-16 in good condition?

YES : Go to Step 2.

NO : Repair the defective connector.

STEP 2. Check the wiring harness between the receiver antenna module connector C-08 (terminal Nos. 2, 1, 8, 12) and the KOS-ECU connector C-05 (terminal Nos. 11, 12, 32, 7) for open circuit.

- (1) Disconnect receiver antenna module connector C-08 and KOS-ECU connector C-05, and check the wiring harness.
- (2) Check the wiring harness between receiver antenna module connector C-08 (terminal No.2) and KOS-ECU connector C-05 (terminal No.11)

OK: Continuity exists (2 Ω or less)

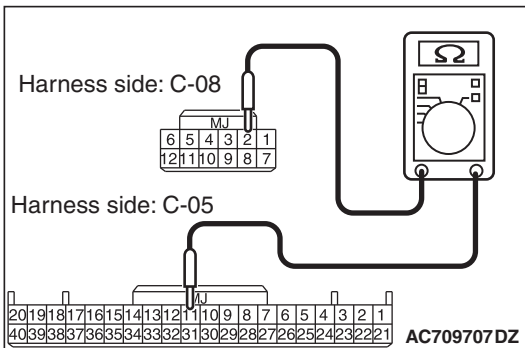

- (3) Check the wiring harness between receiver antenna module connector C-08 (terminal No.1) and KOS-ECU connector C-05 (terminal No.12)

OK: Continuity exists (2 Ω or less)

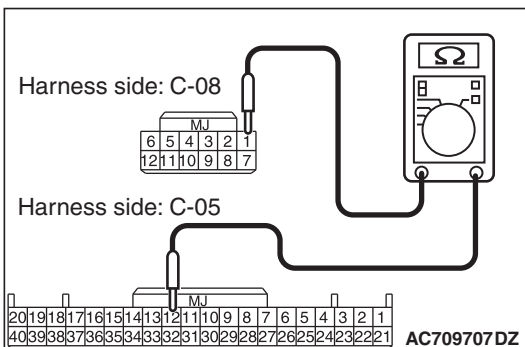

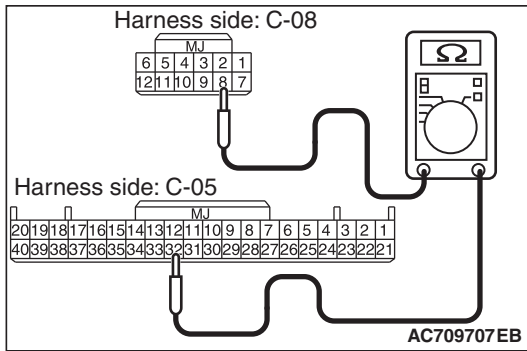

- (4) Check the wiring harness between receiver antenna module connector C-08 (terminal No.8) and KOS-ECU connector C-05 (terminal No.32)

OK: Continuity exists (2 Ω or less)

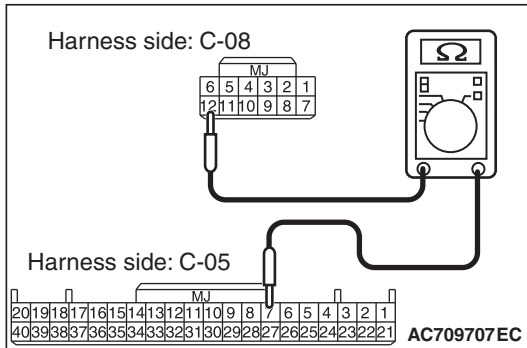

- (5) Check the wiring harness between receiver antenna module connector C-08 (terminal No.12) and KOS-ECU connector C-05 (terminal No.7)

OK: Continuity exists (2 Ω or less)

- Q: Is the wiring harness between receiver antenna module connector C-08 (terminal Nos. 2, 1, 8, 12) and the KOS-ECU connector C-05 (terminal Nos. 11, 12, 32, 7) in good condition?**

YES : Go to Step 3.

NO (receiver antenna module connector C-08 terminal No.2 –KOS-ECU connector C-05 terminal No.11.) :

Repair the wiring harness between receiver antenna module connector C-08 (terminal No. 2) and the KOS-ECU connector C-05 (terminal No. 11).

NO (receiver antenna module connector C-08 terminal No.1 –KOS-ECU connector C-05 terminal No.12.) :

Repair the wiring harness between receiver antenna module connector C-08 (terminal No. 1) and the KOS-ECU connector C-05 (terminal No. 12).

NO (receiver antenna module connector C-08 terminal No.8 –KOS-ECU connector C-05 terminal No.32.) :

Repair the wiring harness between receiver antenna module connector C-08 (terminal No. 8) and the KOS-ECU connector C-05 (terminal No. 32).

NO (receiver antenna module connector C-08 terminal No.12 –KOS-ECU connector C-05 terminal No.7.) :

Repair the wiring harness between receiver antenna module connector C-08 (terminal No. 12) and the KOS-ECU connector C-05 (terminal No. 7).

STEP 3. Check the wiring harness between the receiver antenna module connector C-08 (terminal Nos. 2, 1, 8, 12) and the ground for short circuit.

(1) Disconnect receiver antenna module connector C-08, and check the wiring harness.

(2) Check the wiring harness between receiver antenna module connector C-08 (terminal No.2) and ground

OK: No Continuity

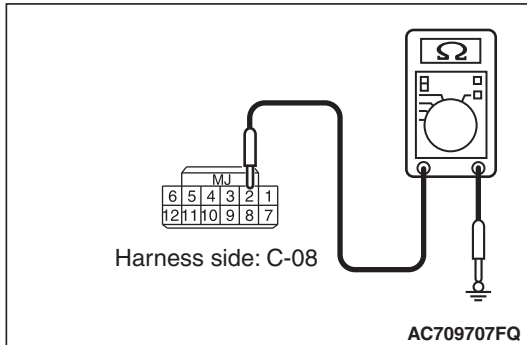

(3) Check the wiring harness between receiver antenna module connector C-08 (terminal No.1) and ground

OK: No Continuity

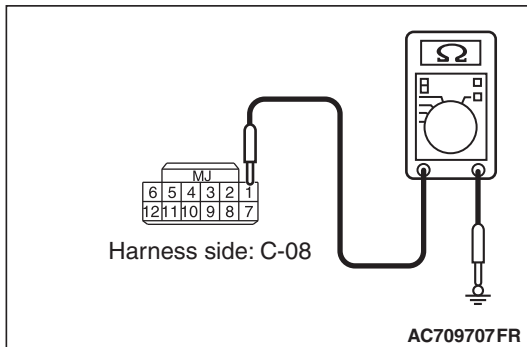

(4) Check the wiring harness between receiver antenna module connector C-08 (terminal No.8) and ground

OK: No Continuity

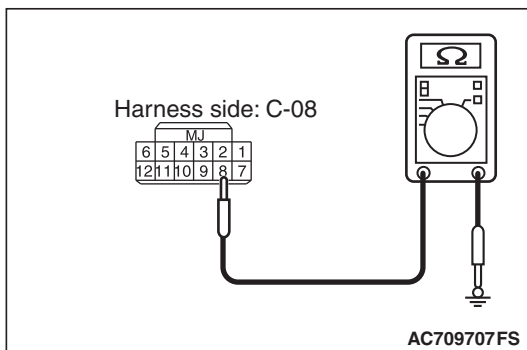

(5) Check the wiring harness between receiver antenna module connector C-08 (terminal No.12) and ground

OK: No Continuity

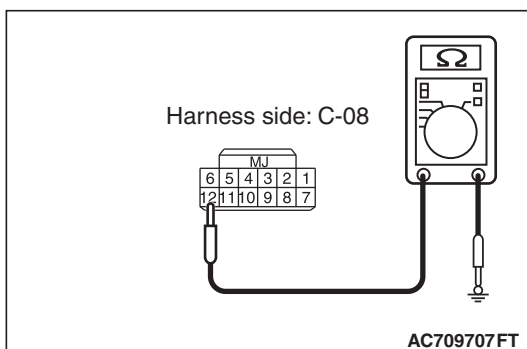

Q: Is the wiring harness between receiver antenna module connector C-08 (terminal Nos. 2, 1, 8, 12) and the ground in good condition?

YES : Go to Step 4.

NO (receiver antenna module connector C-08 terminal No.2 –ground.) : Repair the wiring harness between receiver antenna module connector C-08 (terminal No. 2) and the ground.

NO (receiver antenna module connector C-08 terminal No.1 –ground.) : Repair the wiring harness between receiver antenna module connector C-08 (terminal No. 1) and the ground.

NO (receiver antenna module connector C-08 terminal No.8 –ground.) : Repair the wiring harness between receiver antenna module connector C-08 (terminal No. 8) and the ground.

NO (receiver antenna module connector C-08 terminal No.12 –ground.) : Repair the wiring harness between receiver antenna module connector C-08 (terminal No. 12) and the ground.

STEP 4. Replace the receiver antenna module, and check whether the diagnostic trouble code is reset.

⚠ CAUTION

To prevent damage to scan tool MB991958, always turn the ignition switch to the "LOCK" (OFF) position before connecting or disconnecting scan tool MB991958.

- (1) Connect scan tool MB991958. Refer to "How to connect scan tool (M.U.T.-III) P.42B-9."
- (2) Erase the DTC.
- (3) Turn the ignition switch from the "LOCK" (OFF) position to the "ON" position.
- (4) Check if the DTC is set.

Q: Is the DTC set?

YES : Replace KOS-ECU and register the ID codes (Refer to P.42B-11).

NO : The procedure is complete.

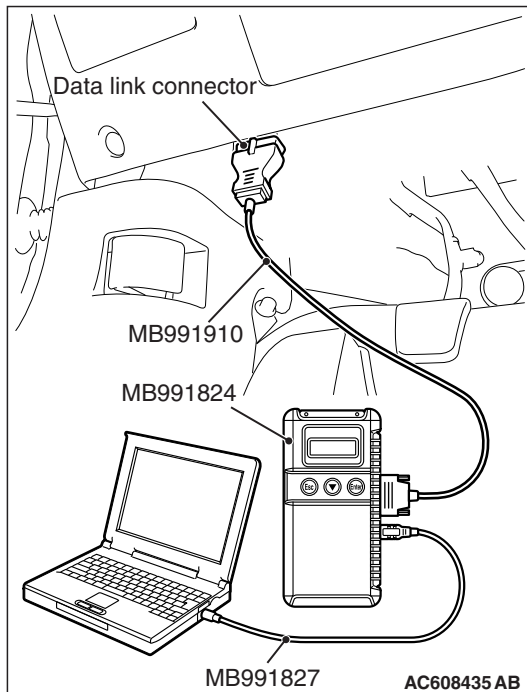

DTC B2400: KOS key registration fail

CAUTION

- If DTC B2400 is set, diagnose the CAN bus lines.
- When replacing the ECU, always check that the communication circuit is normal.

Receiver Antenna Module and KOS-ECU Circuit

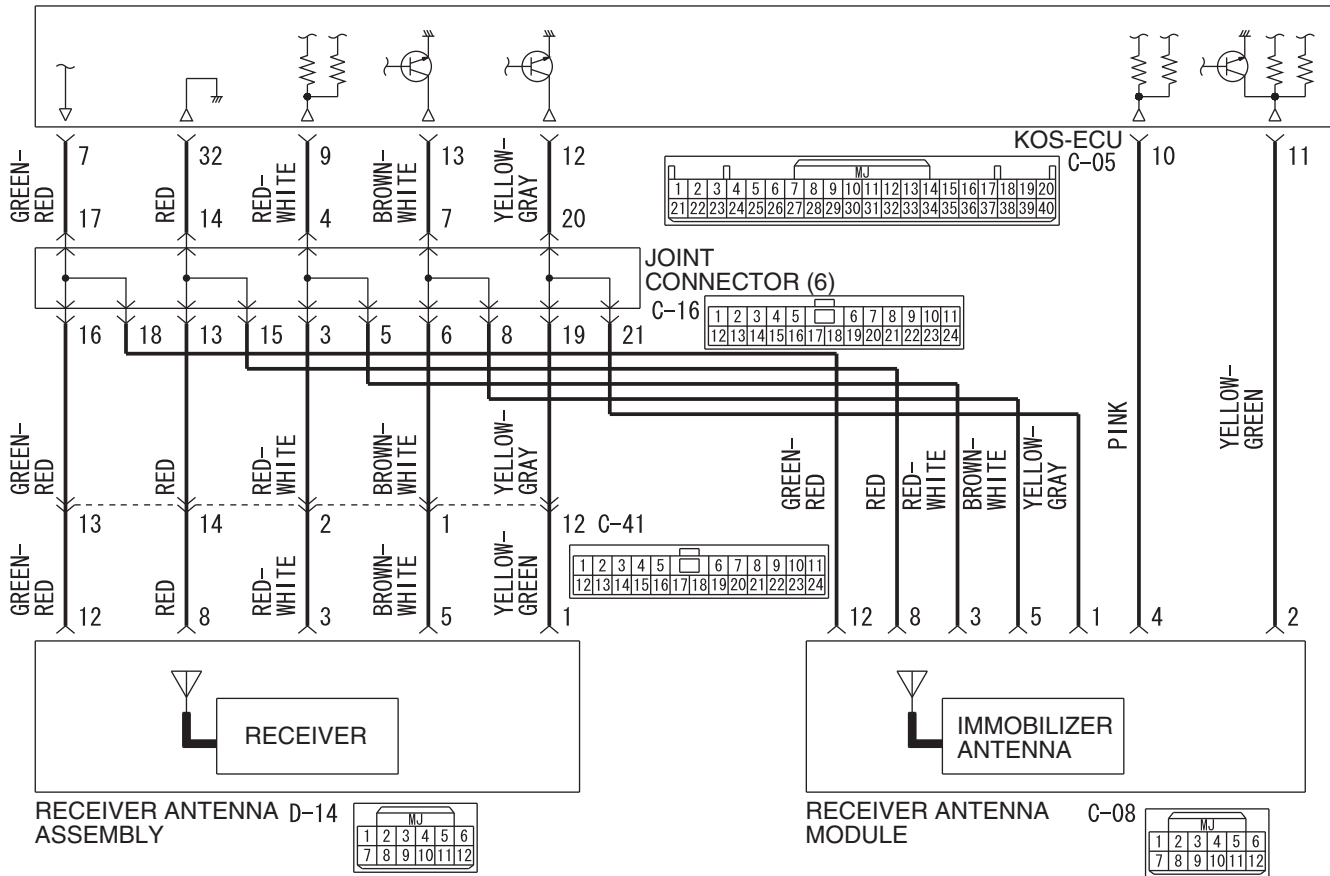

W8H42M003A

Connectors: C-05, C-41

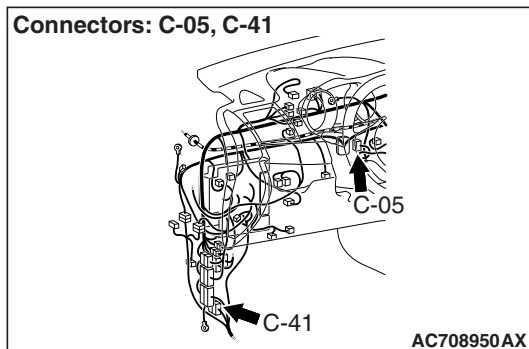

Connectors: C-08, C-16

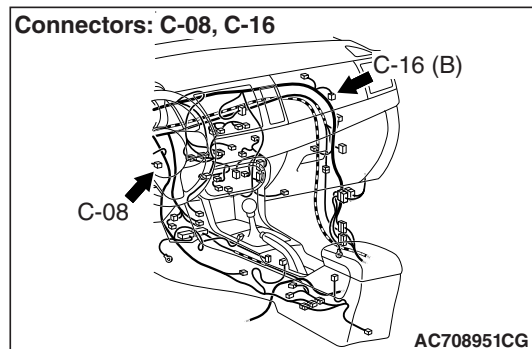

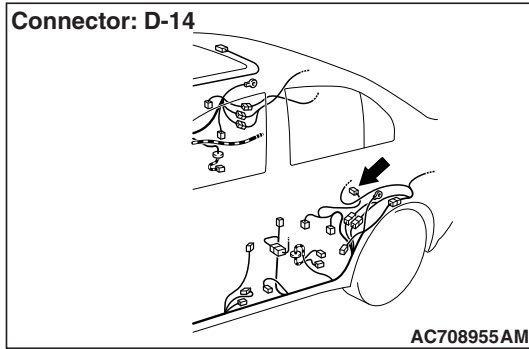

DTC SET CONDITION

If the registration of the keyless operation key ID to KOS-ECU fails, KOS-ECU sets DTC B2400.

TECHNICAL DESCRIPTION (COMMENT)

Assuming that another keyless operation key has already been registered with KOS-ECU, if the registration of the keyless operation key ID fails when a new keyless operation key is added or the existing key is replaced, KOS-ECU determines that there is a problem.

TROUBLESHOOTING HINTS

- Keyless operation key ID registration failure
- Malfunction of the keyless operation key
- Malfunction of CAN bus line
- Battery drain of keyless operation key
- Damaged wiring harness and connectors
- Malfunction of receiver antenna assembly
- Malfunction of receiver antenna module
- Malfunction of KOS-ECU

DIAGNOSIS

Required Special Tools:

- MB991958: Scan Tool (M.U.T.-III Sub Assembly)
 - MB991824: Vehicles Communication Interface (V.C.I.)
 - MB991827: M.U.T.-III USB Cable
 - MB991910: M.U.T.-III Main Harness A

STEP 1. Using scan tool MB991958, diagnose the CAN bus line.

⚠ CAUTION

To prevent damage to scan tool (MB991958), always turn the ignition switch to the "LOCK" (OFF) position before connecting or disconnecting scan tool (MB991958).

- (1) Connect scan tool MB991958 to the data link connector.
- (2) Turn the ignition switch to the "ON" position.
- (3) Diagnose the CAN bus line.
- (4) Turn the ignition switch to the "LOCK" (OFF) position.

Q: Is the CAN bus line found to be normal?

YES : Go to Step 2.

NO : Repair the CAN bus line (Refer to GROUP 54C, Diagnosis [P.54C-15](#)).

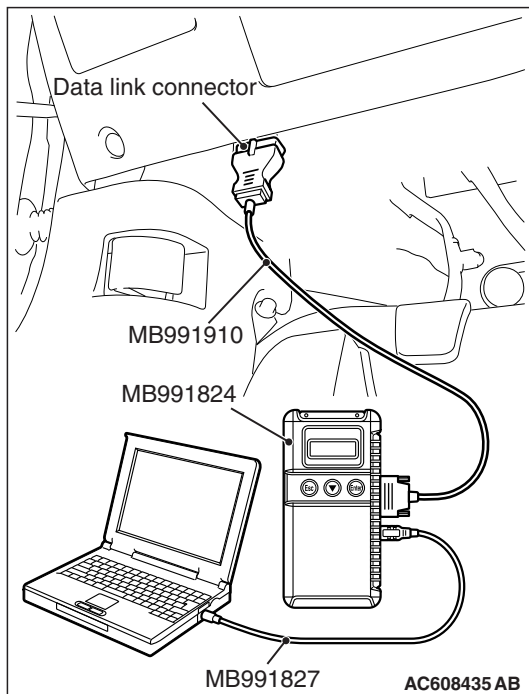

STEP 2. Replace the battery in the keyless operation key and recheck the diagnostic trouble code.

Replace the battery of the keyless operation key for which the DTC is set, and check whether the DTC is reset.

- (1) Turn the ignition switch from the "LOCK" (OFF) position to the "ON" position.
- (2) Check if the DTC is set.

Q: Is the DTC set?

YES : Go to Step 3.

NO : The procedure is complete (Discharged battery).

STEP 3. Replace the keyless operation key and recheck the diagnostic trouble code.

Replace the keyless operation key for which the DTC is set with a new one, register the key ID and keyless operation key ID (refer to [P.42B-11](#)), and check whether the DTC is reset.

- (1) Turn the ignition switch from the "LOCK" (OFF) position to the "ON" position.
- (2) Check if the DTC is set.

Q: Is the DTC set?

YES : Go to Step 4.

NO : The procedure is complete.

STEP 4. Check receiver antenna module connector C-08, receiver antenna assembly connector D-14, KOS-ECU connector C-05, joint connector (6) C-16 and intermittent connector C-41 for loose, corroded or damaged terminals, or terminals pushed back in the connector.

Q: Is the receiver antenna module connector C-08, receiver antenna assembly connector D-14, KOS-ECU connector C-05, joint connector (6) C-16 and intermittent connector C-41 in good condition?

YES : Go to Step 5.

NO : Repair the defective connector.

STEP 5. Check the wiring harness between the receiver antenna assembly connector D-14 (terminal Nos.1, 8, 12, 3, 5) and the KOS-ECU connector C-05 (terminal Nos.12, 32, 7, 9, 13) for open circuit.

- (1) Disconnect receiver antenna assembly connector D-14 and KOS-ECU connector C-05, and check the wiring harness.
- (2) Check the wiring harness between receiver antenna assembly connector D-14 (terminal No.1) and KOS-ECU connector C-05 (terminal No.12)

OK: Continuity exists (2 Ω or less)

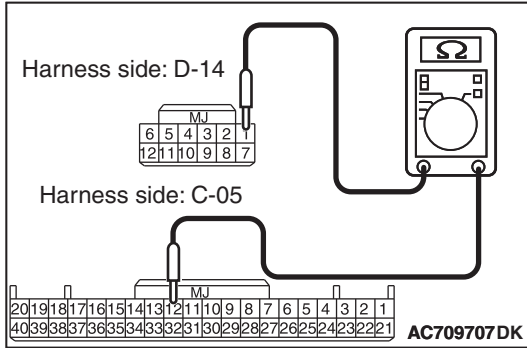

- (3) Check the wiring harness between receiver antenna assembly connector D-14 (terminal No.8) and KOS-ECU connector C-05 (terminal No.32)

OK: Continuity exists (2 Ω or less)

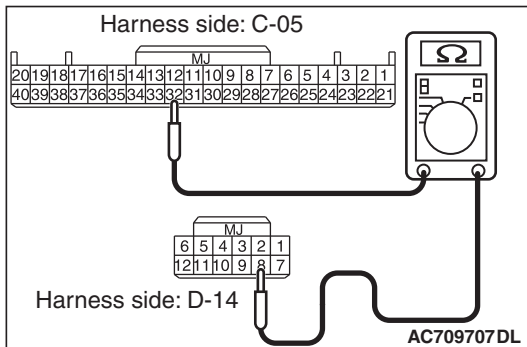

- (4) Check the wiring harness between receiver antenna assembly connector D-14 (terminal No.12) and KOS-ECU connector C-05 (terminal No.7)

OK: Continuity exists (2 Ω or less)

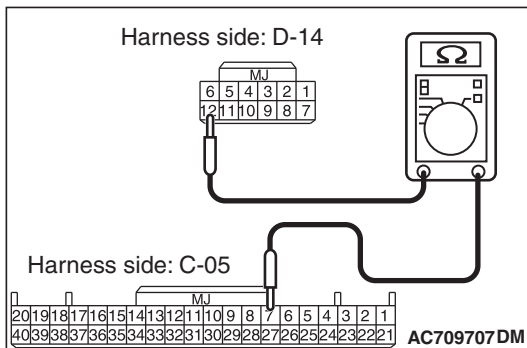

- (5) Check the wiring harness between receiver antenna assembly connector D-14 (terminal No.3) and KOS-ECU connector C-05 (terminal No.9)

OK: Continuity exists (2 Ω or less)

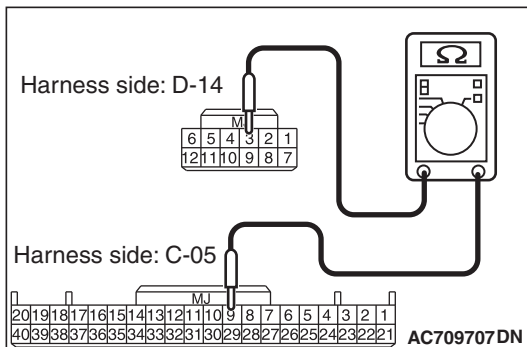

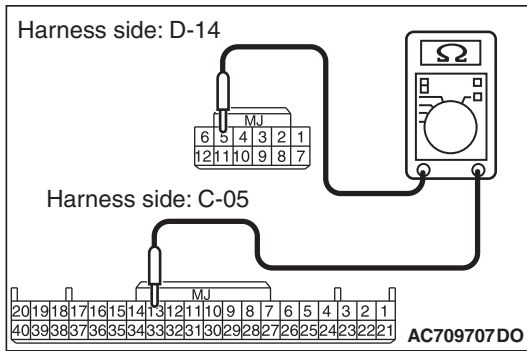

- (6) Check the wiring harness between receiver antenna assembly connector D-14 (terminal No.5) and KOS-ECU connector C-05 (terminal No.13)

OK: Continuity exists (2 Ω or less)

- Q: Is the wiring harness between receiver antenna assembly connector D-14 (terminal Nos.1, 8, 12, 3, 5) and the KOS-ECU connector C-05 (terminal Nos.12, 32, 7, 9, 13) in good condition?**

YES : Go to Step 6.

NO (receiver antenna assembly connector D-14 terminal No.1 –KOS-ECU connector C-05 terminal No.12.) :

Repair the wiring harness between receiver antenna assembly connector D-14 (terminal No.1) and the KOS-ECU connector C-05 (terminal No.12).

NO (receiver antenna assembly connector D-14 terminal No.8 –KOS-ECU connector C-05 terminal No.32.) :

Repair the wiring harness between receiver antenna assembly connector D-14 (terminal No.8) and the KOS-ECU connector C-05 (terminal No.32).

NO (receiver antenna assembly connector D-14 terminal No.12 –KOS-ECU connector C-05 terminal No.7.) :

Repair the wiring harness between receiver antenna assembly connector D-14 (terminal No.12) and the KOS-ECU connector C-05 (terminal No.7).

NO (receiver antenna assembly connector D-14 terminal No.3 –KOS-ECU connector C-05 terminal No.9.) :

Repair the wiring harness between receiver antenna assembly connector D-14 (terminal No.3) and the KOS-ECU connector C-05 (terminal No.9).

NO (receiver antenna assembly connector D-14 terminal No.5 –KOS-ECU connector C-05 terminal No.13.) :

Repair the wiring harness between receiver antenna assembly connector D-14 (terminal No.5) and the KOS-ECU connector C-05 (terminal No.13).

STEP 6. Check the wiring harness between the receiver antenna assembly connector D-14 (terminal Nos.1, 8, 12, 3, 5) and the ground for short circuit.

(1) Disconnect receiver antenna assembly connector D-14, and check the wiring harness.

(2) Check the wiring harness between receiver antenna assembly connector D-14 (terminal No.1) and ground

OK: No continuity

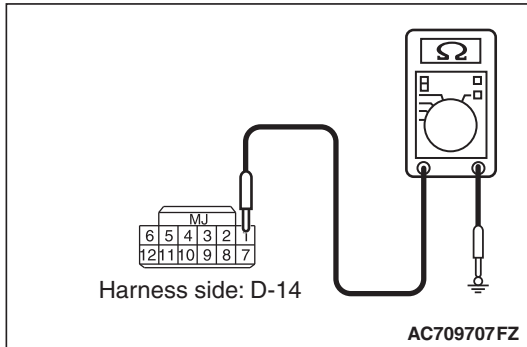

(3) Check the wiring harness between receiver antenna assembly connector D-14 (terminal No.8) and ground

OK: No continuity

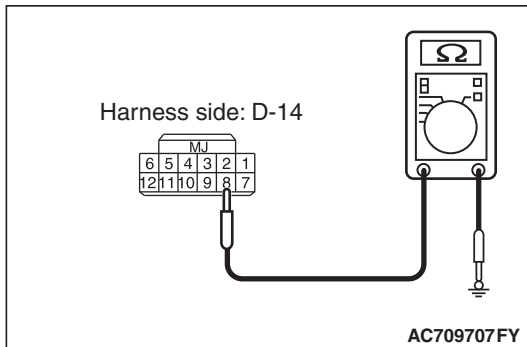

(4) Check the wiring harness between receiver antenna assembly connector D-14 (terminal No.12) and ground

OK: No continuity

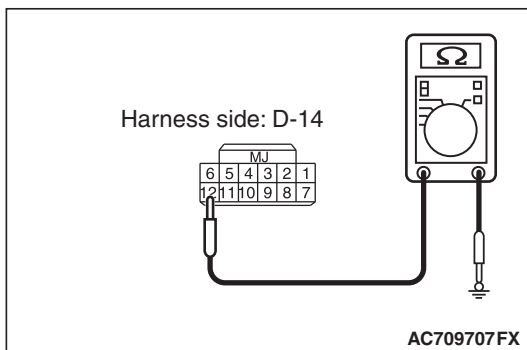

(5) Check the wiring harness between receiver antenna assembly connector D-14 (terminal No.3) and ground

OK: No continuity

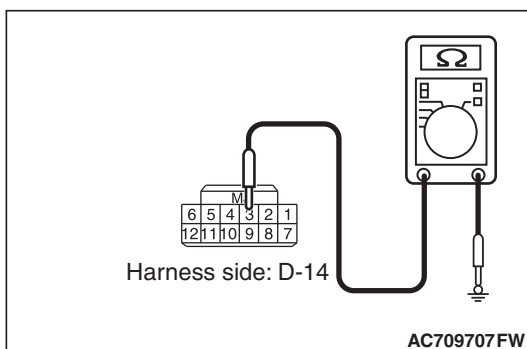

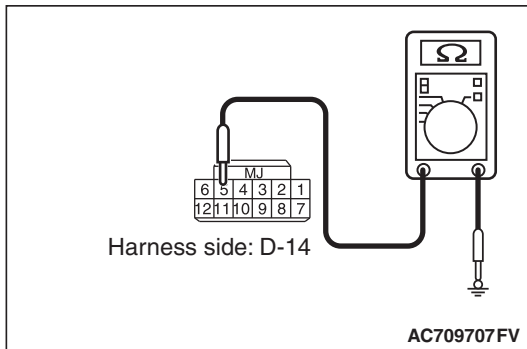

- (6) Check the wiring harness between receiver antenna assembly connector D-14 (terminal No.5) and ground

OK: No continuity

Q: Is the wiring harness between receiver antenna assembly connector D-14 (terminal Nos.1, 8, 12, 3, 5) and the ground in good condition?

YES : Go to Step 7.

NO (receiver antenna assembly connector D-14 terminal No.1 –ground.) : Repair the wiring harness between receiver antenna assembly connector D-14 (terminal No.1) and the ground.

NO (receiver antenna assembly connector D-14 terminal No.8 –ground.) : Repair the wiring harness between receiver antenna assembly connector D-14 (terminal No.8) and the ground.

NO (receiver antenna assembly connector D-14 terminal No.12 –ground.) : Repair the wiring harness between receiver antenna assembly connector D-14 (terminal No.12) and the ground.

NO (receiver antenna assembly connector D-14 terminal No.3 –ground.) : Repair the wiring harness between receiver antenna assembly connector D-14 (terminal No.3) and the ground.

NO (receiver antenna assembly connector D-14 terminal No.5 –ground.) : Repair the wiring harness between receiver antenna assembly connector D-14 (terminal No.5) and the ground.

STEP 7. Replace the receiver antenna assembly, and check whether the diagnostic trouble code is reset.

- (1) Turn the ignition switch from the "LOCK" (OFF) position to the "ON" position.
- (2) Check if the DTC is set.

Q: Is the DTC set?

YES : Go to Step 8.

NO : The procedure is complete.

STEP 8. Check the wiring harness between the receiver antenna module connector C-08 (terminal Nos. 2, 1, 8, 12) and the KOS-ECU connector C-05 (terminal Nos. 11, 12, 32, 7) for open circuit.

- (1) Disconnect receiver antenna module connector C-08 and KOS-ECU connector C-05, and check the wiring harness.
- (2) Check the wiring harness between receiver antenna module connector C-08 (terminal No.2) and KOS-ECU connector C-05 (terminal No.11)

OK: Continuity exists (2 Ω or less)

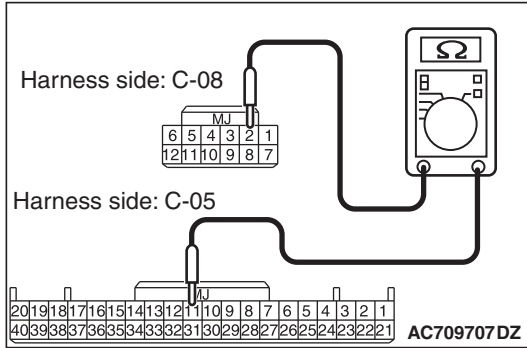

- (3) Check the wiring harness between receiver antenna module connector C-08 (terminal No.1) and KOS-ECU connector C-05 (terminal No.12)

OK: Continuity exists (2 Ω or less)

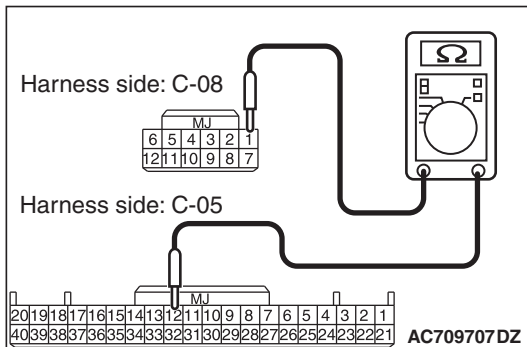

- (4) Check the wiring harness between receiver antenna module connector C-08 (terminal No.8) and KOS-ECU connector C-05 (terminal No.32)

OK: Continuity exists (2 Ω or less)

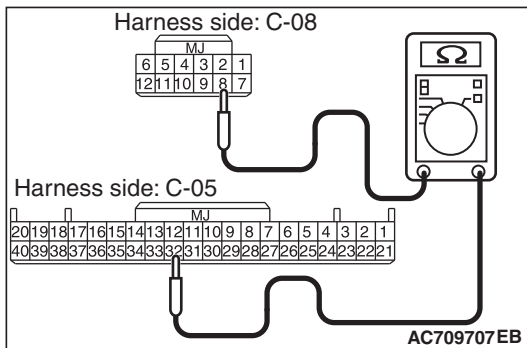

- (5) Check the wiring harness between receiver antenna module connector C-08 (terminal No.12) and KOS-ECU connector C-05 (terminal No.7)

OK: Continuity exists (2 Ω or less)

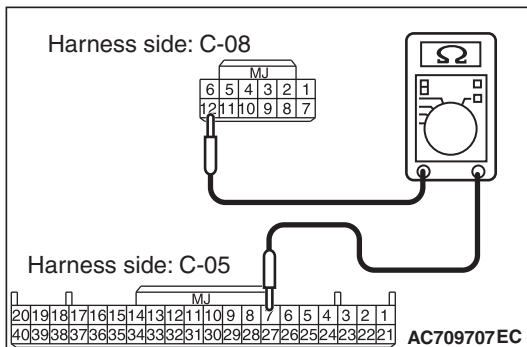

Q: Is the wiring harness between receiver antenna module connector C-08 (terminal Nos. 2, 1, 8, 12) and the KOS-ECU connector C-05 (terminal Nos. 11, 12, 32, 7) in good condition?

YES : Go to Step 9.

NO (receiver antenna module connector C-08 terminal No.2 –KOS-ECU connector C-05 terminal No.11.) :

Repair the wiring harness between receiver antenna module connector C-08 (terminal No. 2) and the KOS-ECU connector C-05 (terminal No. 11).

NO (receiver antenna module connector C-08 terminal No.1 –KOS-ECU connector C-05 terminal No.12.) :

Repair the wiring harness between receiver antenna module connector C-08 (terminal No. 1) and the KOS-ECU connector C-05 (terminal No. 12).

NO (receiver antenna module connector C-08 terminal No.8 –KOS-ECU connector C-05 terminal No.32.) :

Repair the wiring harness between receiver antenna module connector C-08 (terminal No. 8) and the KOS-ECU connector C-05 (terminal No. 32).

NO (receiver antenna module connector C-08 terminal No.12 –KOS-ECU connector C-05 terminal No.7.) :

Repair the wiring harness between receiver antenna module connector C-08 (terminal No. 12) and the KOS-ECU connector C-05 (terminal No. 7).

STEP 9. Check the wiring harness between the receiver antenna module connector C-08 (terminal Nos.2, 1, 8, 12) and the ground for short circuit.

- (1) Disconnect receiver antenna module connector C-08, and check the wiring harness.
- (2) Check the wiring harness between receiver antenna module connector C-08 (terminal No.2) and ground

OK: No continuity

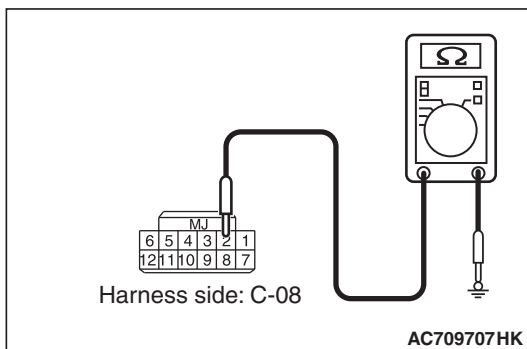

- (3) Check the wiring harness between receiver antenna module connector C-08 (terminal No.1) and ground

OK: No continuity

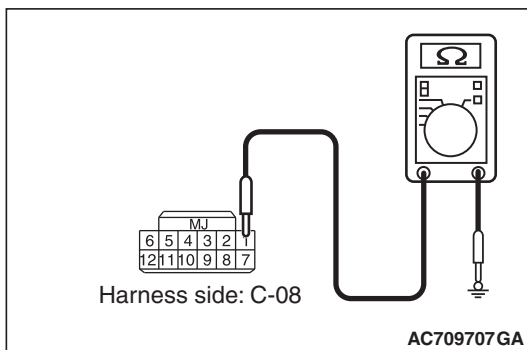

- (4) Check the wiring harness between receiver antenna module connector C-08 (terminal No.8) and ground

OK: No continuity

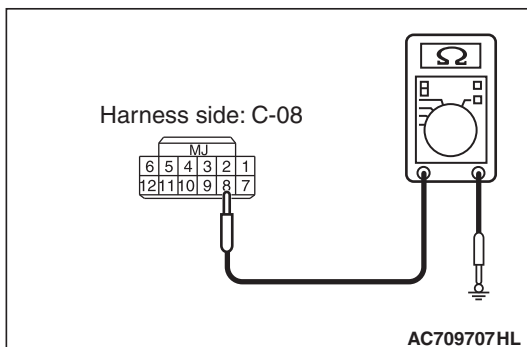

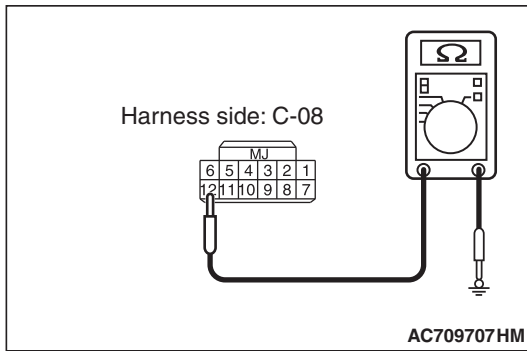

- (5) Check the wiring harness between receiver antenna module connector C-08 (terminal No.12) and ground

OK: No continuity

Q: Is the wiring harness between receiver antenna module connector C-08 (terminal Nos.2, 1, 8, 12) and the ground in good condition?

YES : Go to Step 10.

NO (receiver antenna module connector C-08 terminal No.2 –ground.) : Repair the wiring harness between receiver antenna module connector C-08 (terminal No.2) and the ground.

NO (receiver antenna module connector C-08 terminal No.1 –ground.) : Repair the wiring harness between receiver antenna module connector C-08 (terminal No.1) and the ground.

NO (receiver antenna module connector C-08 terminal No.8 –ground.) : Repair the wiring harness between receiver antenna module connector C-08 (terminal No.8) and the ground.

NO (receiver antenna module connector C-08 terminal No.12 –ground.) : Repair the wiring harness between receiver antenna module connector C-08 (terminal No.12) and the ground.

STEP 10. Replace the receiver antenna module, and check whether the diagnostic trouble code is reset.

- (1) Turn the ignition switch from the "LOCK" (OFF) position to the "ON" position.
- (2) Check if the DTC is set.

Q: Is the DTC set?

YES : Replace KOS-ECU and register the ID codes (Refer to P.42B-11).

NO : The procedure is complete.

DTC B2401: Keyless/KOS key ID not registered

CAUTION

- If DTC B2401 is set, be sure to diagnose the CAN bus line.
- When replacing the ECU, always check that the communication circuit is normal.

DIAGNOSTIC FUNCTION

If no keyless operation key ID is registered with KOS-ECU or if the keyless operation key with ID not registered is used, KOS-ECU sets DTC B2401.

JUDGMENT CRITERIA

If the number of the registered keyless operation keys is 0, or the registration of a keyless operation key fails when the number of the registered keyless operation keys is 0, it is judged as abnormal.

PROBABLE CAUSES

- Malfunction of CAN bus line
- The registration of a keyless operation key ID fails when no keyless operation key ID is registered.
- Malfunction of the keyless operation key
- Malfunction of KOS-ECU

DIAGNOSIS

Required Special Tools:

- MB991958: Scan Tool (M.U.T.-III Sub Assembly)
 - MB991824: Vehicles Communication Interface (V.C.I.)
 - MB991827: M.U.T.-III USB Cable
 - MB991910: M.U.T.-III Main Harness A

STEP 1. Using scan tool MB991958, diagnose the CAN bus line.

⚠ CAUTION

To prevent damage to scan tool (MB991958), always turn the ignition switch to the "LOCK" (OFF) position before connecting or disconnecting scan tool (MB991958).

- (1) Connect scan tool MB991958 to the data link connector.
- (2) Turn the ignition switch to the "ON" position.
- (3) Diagnose the CAN bus line.
- (4) Turn the ignition switch to the "LOCK" (OFF) position.

Q: Is the CAN bus line found to be normal?

YES : Go to Step 2.

NO : Repair the CAN bus line (Refer to GROUP 54C, Diagnosis [P.54C-15](#)).

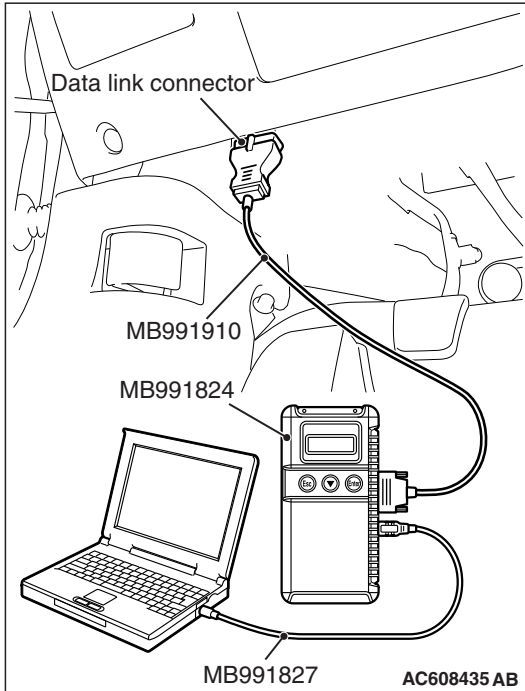

STEP 2. Register the keyless operation key ID and recheck the diagnostic trouble code.

Register the keyless operation key ID (refer to [P.42B-11](#)), and check whether the DTC is reset.

- (1) Turn the ignition switch from the "LOCK" (OFF) position to the "ON" position.
- (2) Check if the DTC is set.

Q: Is the DTC set?

YES : Go to Step 3.

NO : The procedure is complete.

STEP 3. Replace the keyless operation key and recheck the diagnostic trouble code.

Replace the keyless operation key for which the DTC is set with a new one, register the key ID and keyless operation key ID (refer to P.42B-11), and check whether the DTC is reset.

- (1) Turn the ignition switch from the "LOCK" (OFF) position to the "ON" position.
- (2) Check if the DTC is set.

Q: Is the DTC set?

YES : Replace KOS-ECU and register the ID codes (Refer to P.42B-11).

NO : The procedure is complete.

- DTC B2402: STL unit comm.(system ID)
- DTC B2403: STL unit comm.(CRC)
- DTC B2404: STL unit comm.(function code)
- DTC B2405: STL unit comm.(rolling code)
- DTC B2406: STL unit comm.(PTC operate)
- DTC B2407: STL unit comm.(EEPROM)
- DTC B2408: STL unit comm.(solenoid)

CAUTION

- If DTC B2402, B2403, B2404, B2405, B2406, B2407, or B2408 is set, diagnose the CAN bus lines.
- Whenever the steering lock unit is replaced, ensure that the communication circuit is normal.

Key Reminder Switch and KOS-ECU Circuit

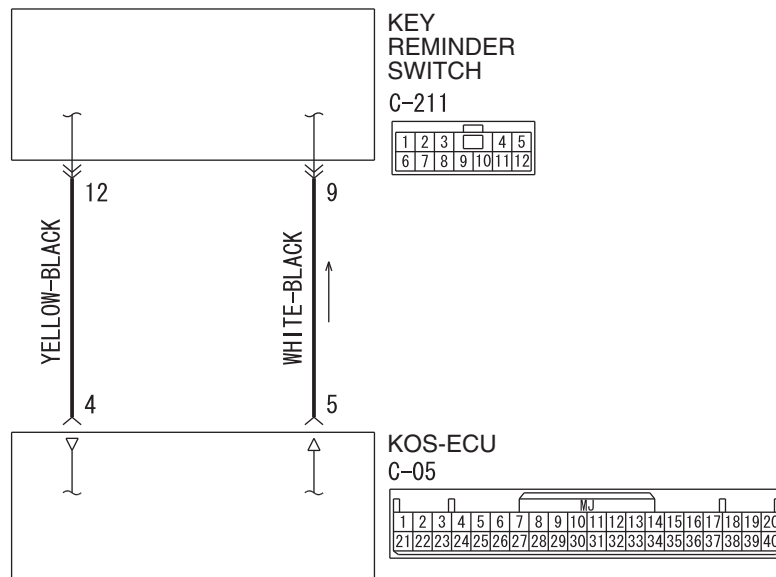

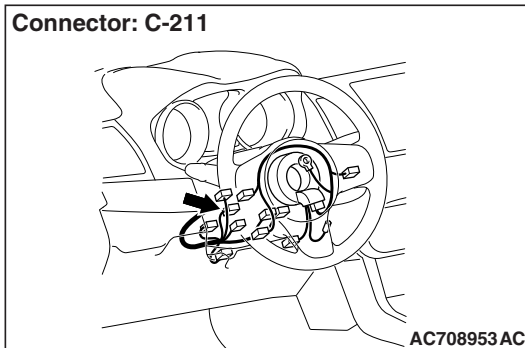
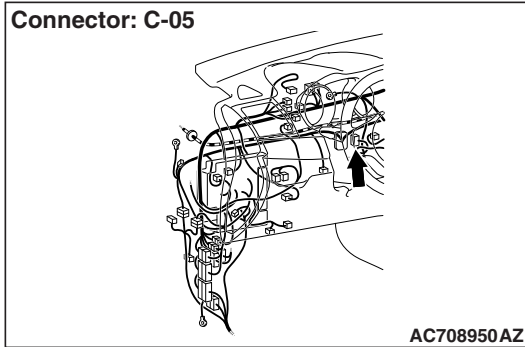

- B2406: PTC thermistor continuously activated or activated to prevent solenoid abnormal heating on the communication with steering lock unit
- B2407: EEPROM failure
- B2408: Communication error between the steering lock unit and KOS-ECU, or solenoid failure

TECHNICAL DESCRIPTION (COMMENT)

Range of check

- When the IG knob unlock communication is performed by pressing the ignition push switch

Judgment criteria

- B2402: Steering lock unit communication error (system ID) or received system ID error
- B2403: Steering lock unit communication error (CRC) or received frame CRC calculation result discrepancy
- B2404: Steering lock unit communication error (function code) or received frame function code undefined
- B2405: Steering lock unit communication error (rolling code) or received rolling code out of the permissible range
- B2406: Steering lock unit communication error (PTC operation) or PTC thermistor activated to prevent solenoid abnormal heating
- B2407: Steering lock unit communication error (EEPROM) or RRPROM failure
- B2408: Steering lock unit communication error (solenoid) or solenoid failure

DTC SET CONDITION

When the ignition push switch is pressed, the steering lock unit communicates with KOS-ECU to unlock the IG knob. However, if there is a failure shown below, the corresponding DTC is set.

- B2402: System ID (vehicle specific code) failure
- B2403: Cyclic Redundancy Check (CRC): The error detection strategy to detect a continuously occurring error (burst error), the calculation result discrepancy
- B2404: Function code failure
- B2405: Rolling code (automatically changing a code for lock/unlock each time when a lock operation is performed)

TROUBLESHOOTING HINTS

- Malfunction of the key reminder switch (integrated into the steering lock unit)
- Wiring harness or connector failure of CAN bus line
- Malfunction of the KOS-ECU

DIAGNOSIS

Required Special Tools:

- MB991958 Scan Tool (M.U.T.-III Sub Assembly)
 - MB991824: Vehicles Communication Interface (V.C.I.)
 - MB991827 M.U.T.-III USB Cable
 - MB991910 M.U.T.-III Main Harness A

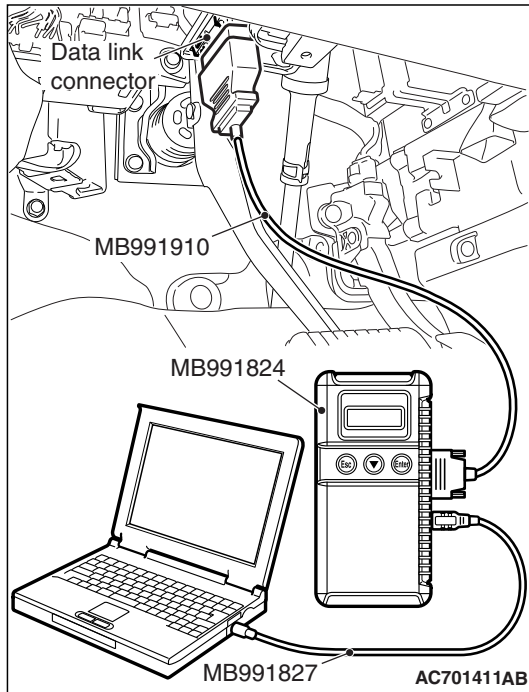

STEP 1. Using scan tool MB991958, diagnose the CAN bus line.

⚠ CAUTION

To prevent damage to scan tool (MB991958), always turn the ignition switch to the "LOCK" (OFF) position before connecting or disconnecting scan tool (MB991958).

- (1) Connect scan tool MB991958 to the data link connector.
- (2) Turn the ignition switch to the "ON" position.
- (3) Diagnose the CAN bus line.
- (4) Turn the ignition switch to the "LOCK" (OFF) position.

Q: Is the CAN bus line found to be normal?

YES : Go to Step 2.

NO : Repair the CAN bus line (Refer to GROUP 54C – Diagnosis P.54C-15).

STEP 2. Diagnostic trouble code check

Q: Is DTC No.B2402 set?

YES : Go to Step 3

NO : Go to Step 6

STEP 3. Check exchange of KOS-ECU

Check whether the KOS-ECU was exchanged.

Q: Is the check result normal?

YES : Go to Step 4

NO : Go to Step 6

STEP 4. Check exchange of steering lock unit

Check whether the steering lock unit was exchanged.

Q: Is the check result normal?

YES : Go to Step 6

NO : Go to Step 5

STEP 5. Check registered of steering lock unit

Check whether KOS-ID was registered to the steering lock unit.

Q: Is the check result normal?

YES : Go to Step 6

NO : Check registration flow chart and register the ID codes (Refer to P.42B-11). Then go to Step 10.

STEP 6. Check key reminder switch connector C-211 and KOS-ECU connector C-05 for loose, corroded or damaged terminals, or terminals pushed back in the connector.

Q: Is the key reminder switch connector C-211 and KOS-ECU connector C-05 in good condition?

YES : Go to Step 7.

NO : Repair the defective connector.

STEP 7. Wiring harness check between C-211 key reminder switch connector and C-05 KOS-ECU connector for open circuit.

(1) Disconnect C-211 key reminder switch connector and C-05 KOS-ECU connector.

(2) Measure at the connector side of C-211 key reminder switch connector and C-05 KOS-ECU connector.

(3) Measure the resistance between the terminals.

- C-211 key reminder switch connector terminal No.9 – C-05 KOS-ECU connector terminal No.5.

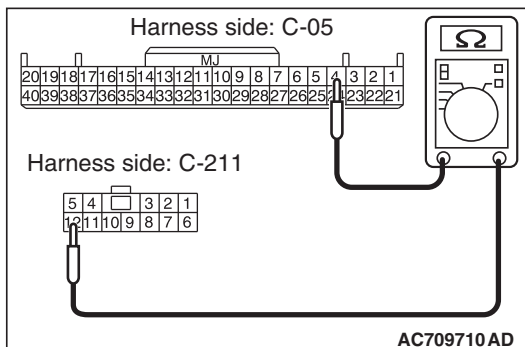
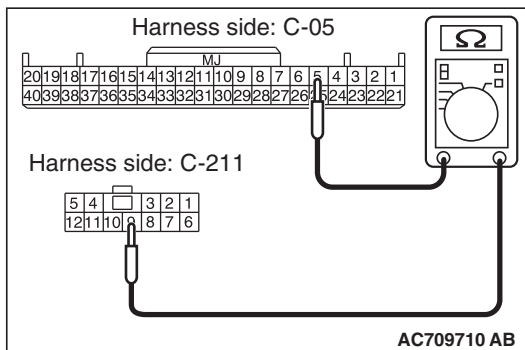

- C-211 key reminder switch connector terminal No.12 – C-05 KOS-ECU connector terminal No.4.

OK: Continuity exists (2Ω or less)

Q: Is the check result normal?

YES : Go to Step 8.

NO (C-211 key reminder switch connector terminal No.9 –C-05 KOS-ECU connector terminal No.5.) : An open circuit is present in the wiring harness between C-211 key reminder switch connector terminal No. 9 and C-05 KOS-ECU connector terminal No. 5. Repair the wiring harness.

NO (C-211 key reminder switch connector terminal No.12 –C-05 KOS-ECU connector terminal No.4.) : An open circuit is present in the wiring harness between C-211 key reminder switch connector terminal No. 12 and C-05 KOS-ECU connector terminal No. 4. Repair the wiring harness.

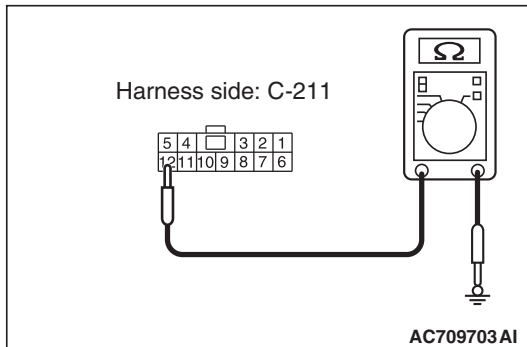
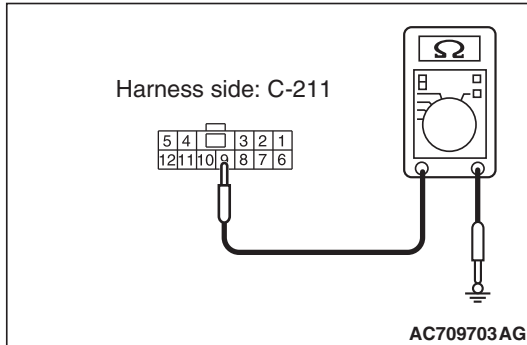

STEP 8. Check the wiring harness between the C-211 key reminder switch connector (terminal Nos. 9, 12) and the ground for short circuit.

- (1) Disconnect C-211 key reminder switch connector, and check the wiring harness.
- (2) Check the wiring harness between C-211 key reminder switch connector (terminal No.9) and ground

OK: No Continuity

- (3) Check the wiring harness between C-211 key reminder switch connector (terminal No.12) and ground

OK: No Continuity

Q: Is the wiring harness between C-211 key reminder switch connector (terminal No. 9, 12) and the ground in good condition?

YES : Go to Step 9.

NO (key reminder switch connector C-211 terminal No.9 –ground.) : Repair the wiring harness between C-211 key reminder switch connector (terminal No. 9) and the ground.

NO (key reminder switch connector C-211 terminal No.12 –ground.) : Repair the wiring harness C-211 key reminder switch connector (terminal No. 12) and the ground.

STEP 9. Replace the key reminder switch, and check whether the diagnostic trouble code is reset.

- (1) Erase the DTC.
- (2) Turn the ignition switch from the "LOCK" (OFF) position to the "ON" position.
- (3) Check if the DTC is set.

Q: Is the DTC set?

YES : Replace KOS-ECU and register the ID codes (Refer to P.42B-11).

NO : The trouble can be an intermittent malfunction (Refer to GROUP 00 –How to use Troubleshooting/inspection Service Points –How to Cope with Intermittent Malfunction P.00-15).

STEP 10. Check whether the diagnostic trouble code is reset.

- (1) Erase the DTC.
- (2) Turn the ignition switch from the "LOCK" (OFF) position to the "ON" position.
- (3) Check if the DTC is set.

Q: Is the DTC set?

YES : Replace KOS-ECU and register the ID codes. (Refer to P.42B-11.)

NO : The procedure is complete.

DTC B2409 STL unit comm.(No response)

CAUTION

- If DTC B2409 is set, diagnose the CAN bus lines.
- Whenever the steering lock unit is replaced, ensure that the communication circuit is normal.

Key Reminder Switch and KOS-ECU Circuit

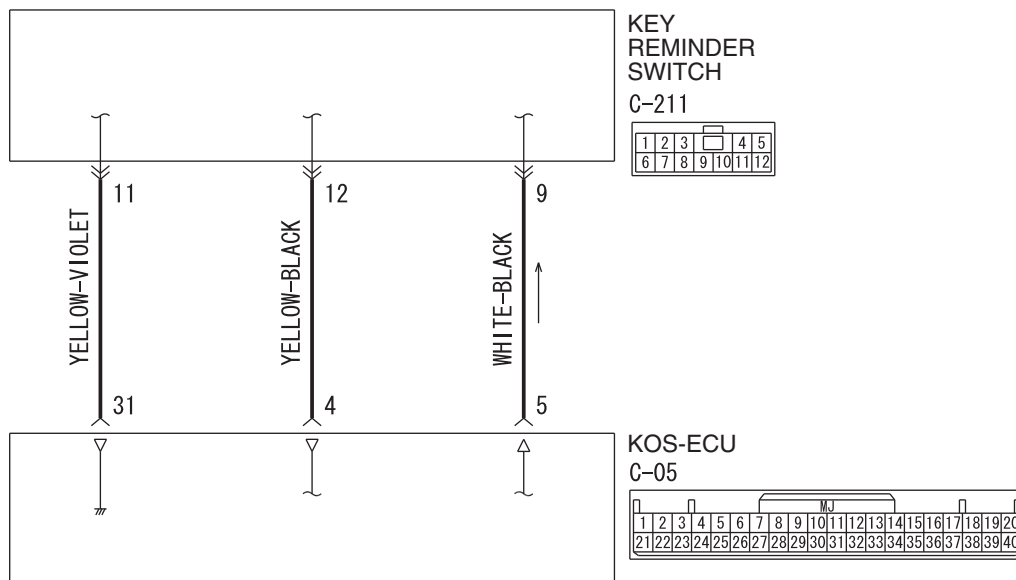

W8G37M005A

Connector: C-05

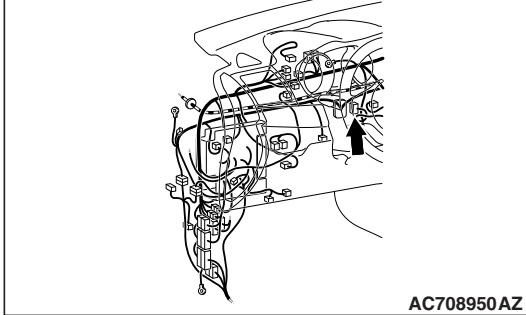

Connector: C-211

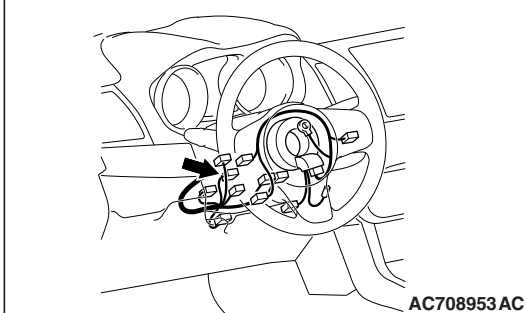
**DTC SET CONDITION**

When the ignition push switch is pressed, the steering lock unit communicates with KOS-ECU to unlock the IG knob. If the steering lock unit communication error (no response) occurs at this time, the DTC is set.

TECHNICAL DESCRIPTION (COMMENT)

When the IG knob unlock communication is performed by pressing the ignition push switch, if the steering lock unit communication error (no response) occurs, the steering lock unit is judged as abnormal.

TROUBLESHOOTING HINTS

- Malfunction of the key reminder switch (integrated into the steering lock unit)
- Wiring harness or connector failure of CAN bus line
- Malfunction of the KOS-ECU

DIAGNOSIS**Required Special Tools:**

- MB991958 Scan Tool (M.U.T.-III Sub Assembly)
 - MB991824: Vehicles Communication Interface (V.C.I.)
 - MB991827 M.U.T.-III USB Cable
 - MB991910 M.U.T.-III Main Harness A

STEP 1. Using scan tool MB991958, diagnose the CAN bus line.

⚠ CAUTION

To prevent damage to scan tool (MB991958), always turn the ignition switch to the "LOCK" (OFF) position before connecting or disconnecting scan tool (MB991958).

- (1) Connect scan tool MB991958 to the data link connector.
- (2) Turn the ignition switch to the "ON" position.
- (3) Diagnose the CAN bus line.
- (4) Turn the ignition switch to the "LOCK" (OFF) position.

Q: Is the CAN bus line found to be normal?

YES : Go to Step 2.

NO : Repair the CAN bus line. (Refer to GROUP 54C – Diagnosis P.54C-15).

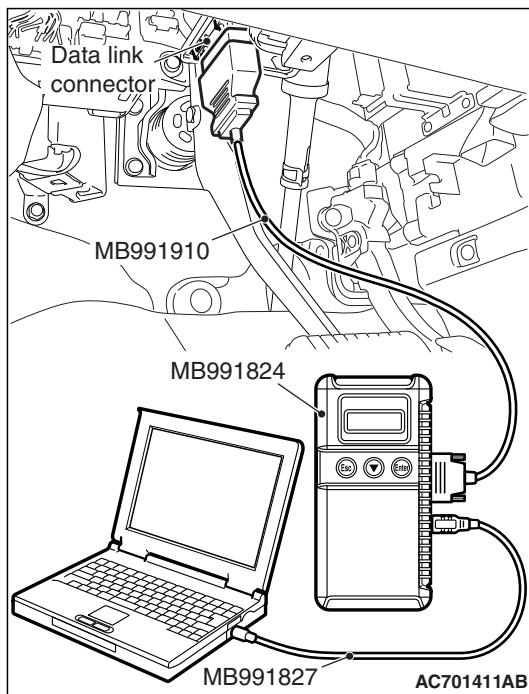

STEP 2. Check key reminder switch connector C-211 and KOS-ECU connector C-05 for loose, corroded or damaged terminals, or terminals pushed back in the connector.

Q: Is the key reminder switch connector C-211 and KOS-ECU connector C-05 in good condition?

YES : Go to Step 3.

NO : Repair the defective connector.

STEP 3. Wiring harness check between C-211 key reminder switch connector and C-05 KOS-ECU connector for open circuit.

- (1) Disconnect C-211 key reminder switch connector and C-05 KOS-ECU connector.
- (2) Measure at the connector side of C-211 key reminder switch connector and C-05 KOS-ECU connector.
- (3) Measure the resistance between the terminals.

- C-211 key reminder switch connector terminal No.9 – C-05 KOS-ECU connector terminal No.5.

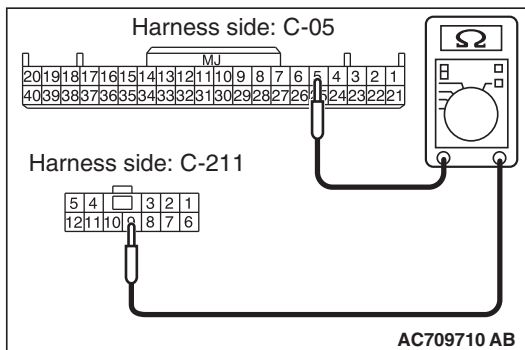

- C-211 key reminder switch connector terminal No.11 – C-05 KOS-ECU connector terminal No.31.

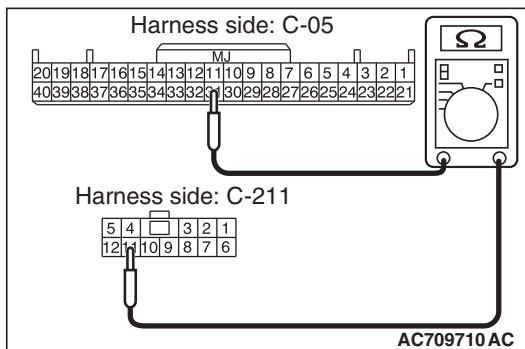

- C-211 key reminder switch connector terminal No.12 – C-05 KOS-ECU connector terminal No.4.

OK: Continuity exists (2Ω or less)

Q: Is the check result normal?

YES : Go to Step 4.

NO (C-211 key reminder switch connector terminal No.9 –C-05 KOS-ECU connector terminal No.5.) : An open circuit is present in the wiring harness between C-211 key reminder switch connector terminal No. 9 and C-05 KOS-ECU connector terminal No. 5. Repair the wiring harness.

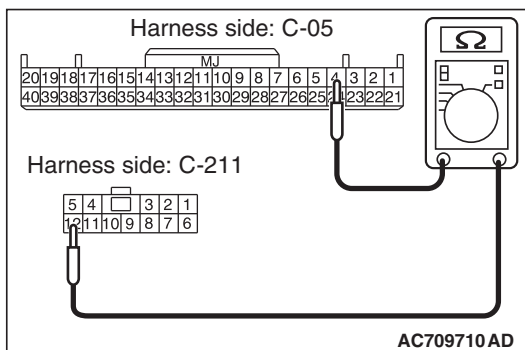

NO (C-211 key reminder switch connector terminal No.11 –C-05 KOS-ECU connector terminal No.31.) : An open circuit is present in the wiring harness between C-211 key reminder switch connector terminal No. 11 and C-05 KOS-ECU connector terminal No. 31.
Repair the wiring harness.

NO (C-211 key reminder switch connector terminal No.12 –C-05 KOS-ECU connector terminal No.4.) : An open circuit is present in the wiring harness between C-211 key reminder switch connector terminal No. 12 and C-05 KOS-ECU connector terminal No. 4. Repair the wiring harness.

STEP 4. Check the wiring harness between the C-211 key reminder switch connector (terminal Nos. 9, 11, 12) and the ground for short circuit.

- (1) Disconnect C-211 key reminder switch connector, and check the wiring harness.
- (2) Check the wiring harness between C-211 key reminder switch connector (terminal No.9) and ground

OK: No Continuity

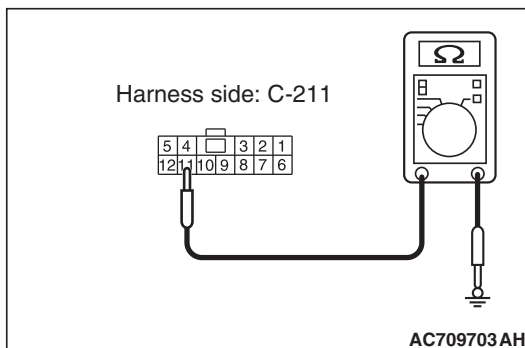
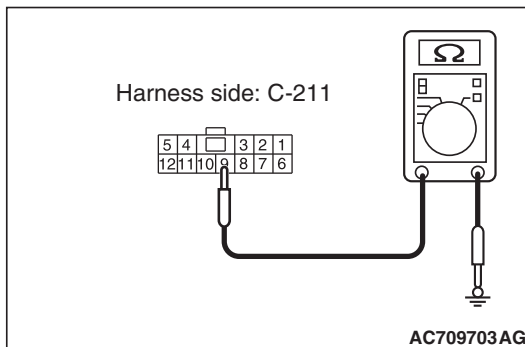

- (3) Check the wiring harness between C-211 key reminder switch connector (terminal No.11) and ground

OK: No Continuity

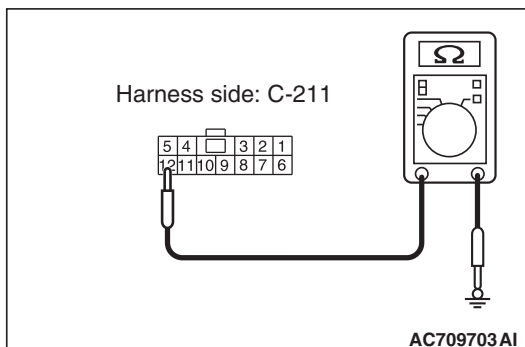

- (4) Check the wiring harness between C-211 key reminder switch connector (terminal No.12) and ground

OK: No Continuity

Q: Is the wiring harness between C-211 key reminder switch connector (terminal No. 9, 11, 12) and the ground in good condition?

YES : Go to Step 5.

NO (key reminder switch connector C-211 terminal No.9 –ground.) : Repair the wiring harness between C-211 key reminder switch connector (terminal No. 9) and the ground.

NO (key reminder switch connector C-211 terminal No.11 –ground.) : Repair the wiring harness between C-211 key reminder switch connector (terminal No. 11) and the ground.

NO (key reminder switch connector C-211 terminal No.12 –ground.) : Repair the wiring harness C-211 key reminder switch connector (terminal No. 12) and the ground.

STEP 5. Replace the key reminder switch, and check whether the diagnostic trouble code is reset.

- (1) Erase the DTC.
- (2) Turn the ignition switch from the "LOCK" (OFF) position to the "ON" position.
- (3) Check if the DTC is set.

Q: Is the DTC set?

YES : Replace KOS-ECU and register the ID codes (Refer to [P.42B-11](#)).

NO : The trouble can be an intermittent malfunction (Refer to GROUP 00 –How to use Troubleshooting/inspection Service Points –How to Cope with Intermittent Malfunction [P.00-17](#)).

DTC B240A: DR side antenna(outdoor) open

CAUTION

When replacing the ECU, always check that the communication circuit is normal.

Outside Transmission Antenna assembly (Driver's Side) Circuit

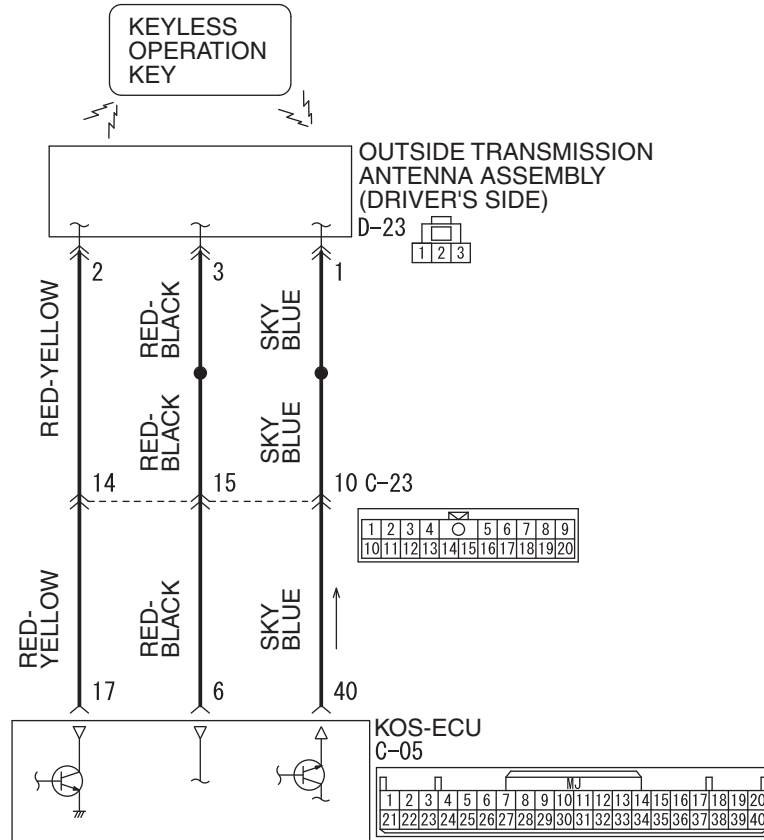

AC609050AC

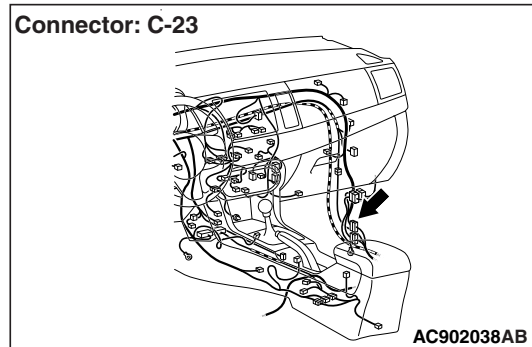
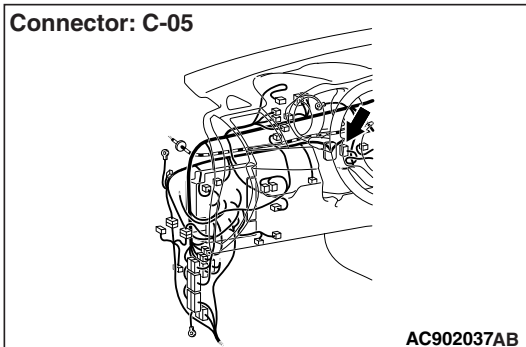

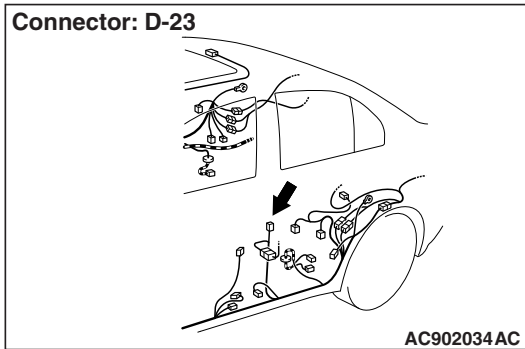

TECHNICAL DESCRIPTION (COMMENT)

When the ignition push switch is pressed, or when the antenna open circuit detection request is received from the diagnosis function, the failure is detected.

TROUBLESHOOTING HINTS

- Malfunction of the outside transmission antenna assembly (driver's side)
- Malfunction of the KOS-ECU
- Damaged wiring harness and connectors

DTC SET CONDITION

If an open circuit is detected in the outside transmission antenna (driver's side), the DTC is set.

DIAGNOSIS

STEP 1. Check KOS-ECU connector C-05 and outside transmission antenna assembly (driver's side) connector D-23 for loose, corroded or damaged terminals, or terminals pushed back in the connector.

Q: Are KOS-ECU connector C-05 and outside transmission antenna assembly (driver's side) connector D-23 in good condition?

YES : Go to Step 2.

NO : Repair or replace the damaged component(s). Refer to GROUP 00E, Harness Connector Inspection [P.00E-2](#). Check that the outside transmission antenna assembly (driver's side) works normally.

STEP 2. Check the wiring harness between KOS-ECU connector C-05 (terminal Nos. 6, 17, 40) and outside transmission antenna assembly (driver's side) connector D-23 (terminal Nos. 3, 2, 1).

- Check the communication, power supply, and ground wires for open circuit.

NOTE: Also check intermediate connector C-23 for loose, corroded, or damaged terminals, or terminals pushed back in the connector. If intermediate connector C-23 is damaged, repair or replace the damaged component(s) as described in GROUP 00E, Harness Connector Inspection [P.00E-2](#).

Q: Are the wiring harness between KOS-ECU connector C-05 (terminal Nos. 6, 17, 40) and outside transmission antenna assembly (driver's side) connector D-23 (terminal Nos. 3, 2, 1) in good condition?

YES : Go to Step 3.

NO : The wiring harness may be damaged or the connector(s) may have loose, corroded or damaged terminals, or terminals pushed back in the connector. Repair the wiring harness as necessary. Check that the outside transmission antenna assembly (driver's side) works normally.

STEP 3. Keyless operation system communication test

Check that the communication with the outside transmission antenna assembly (driver's side) is normal (Refer to Antenna Test [P.42B-236](#)).

Antennas to be checked

- Driver side antenna (exterior)

OK: Normal is displayed.

Q: Is the check result normal?

YES : Go to Step 4.

NO : Replace the outside transmission antenna assembly (driver's side).

STEP 4. Check whether the diagnostic trouble code is reset.

(1) Erase the DTC.

(2) Turn the ignition switch from the LOCK (OFF) position to the ON position.

(3) Check if the DTC is set.

Q: Is the DTC set?

YES : Replace KOS-ECU and register the ID codes (Refer to [P.42B-11](#)).

NO : Intermittent malfunction is suspected (Refer to GROUP 00 –How to Use Troubleshooting/Inspection Service Points –How to Deal with Intermittent Malfunction [P.00-15](#)).

DTC B240B: PS side antenna(outdoor) open

CAUTION

When replacing the ECU, always check that the communication circuit is normal.

Outside Transmission Antenna assembly (Passenger's Side) Circuit

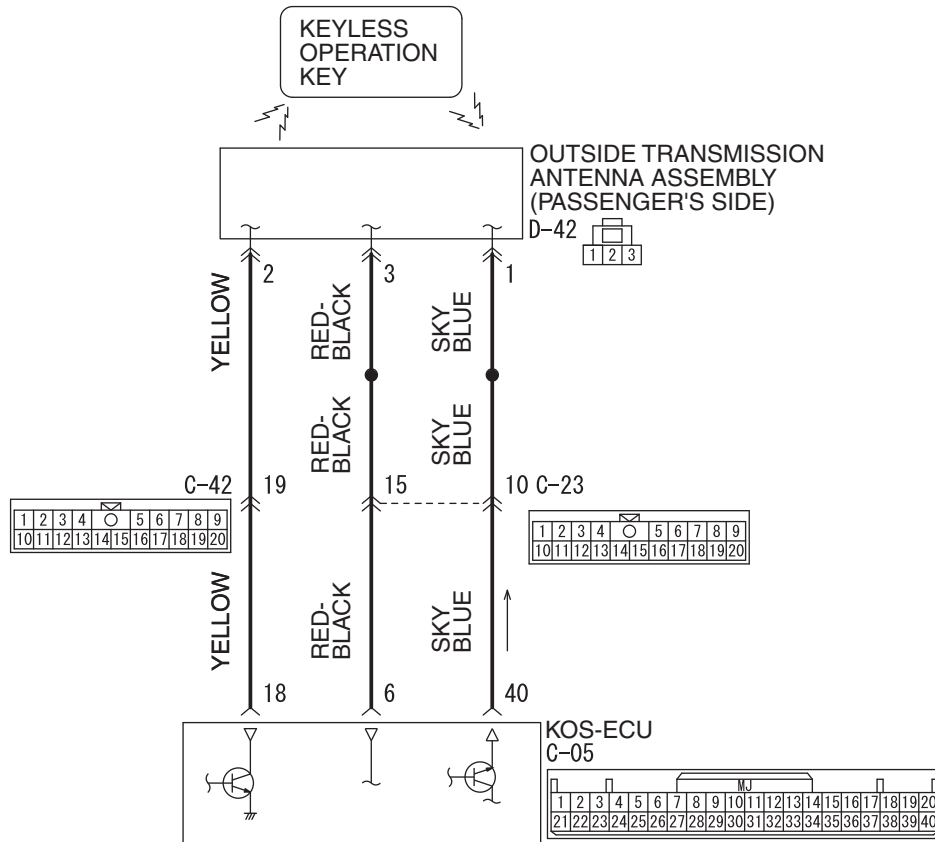

AC609049AC

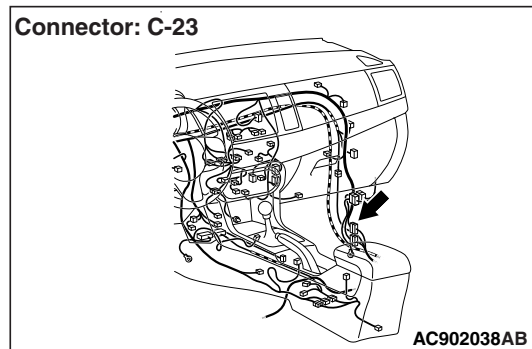
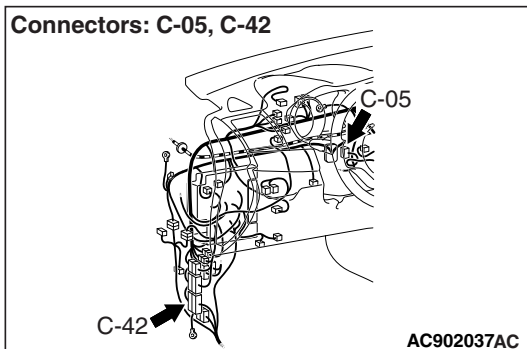

Connector: D-42

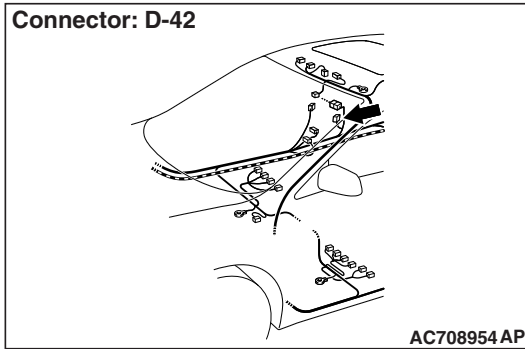
**TECHNICAL DESCRIPTION (COMMENT)**

When the ignition push switch is pressed, or when the antenna open circuit detection request is received from the diagnosis function, the failure is detected.

TROUBLESHOOTING HINTS

- Malfunction of the outside transmission antenna assembly (passenger's side)
- Malfunction of the KOS-ECU
- Damaged wiring harness and connectors

DTC SET CONDITION

If an open circuit is detected in the outside transmission antenna (passenger's side), the DTC is set.

DIAGNOSIS

STEP 1. Check KOS-ECU connector C-05 and outside transmission antenna assembly (passenger's side) connector D-42 for loose, corroded or damaged terminals, or terminals pushed back in the connector.

Q: Are KOS-ECU connector C-05 and outside transmission antenna assembly (passenger's side) connector D-42 in good condition?

YES : Go to Step 2.

NO : Repair or replace the damaged component(s). Refer to GROUP 00E, Harness Connector Inspection [P.00E-2](#). Check that the outside transmission antenna assembly (passenger's side) works normally.

STEP 2. Check the wiring harness between KOS-ECU connector C-05 (terminal Nos. 6, 18, 40) and outside transmission antenna assembly (passenger's side) connector D-42 (terminal Nos. 3, 2, 1).

- Check the communication, power supply, and ground wires for open circuit.

NOTE: Also check intermediate connectors C-23, C-42 for loose, corroded, or damaged terminals, or terminals pushed back in the connector. If intermediate connectors C-23, C-42 is damaged, repair or replace the damaged component(s) as described in GROUP 00E, Harness Connector Inspection P.00E-2.

Q: Are the wiring harness between KOS-ECU connector C-05 (terminal Nos. 6, 18, 40) and outside transmission antenna assembly (passenger's side) connector D-42 (terminal Nos. 3, 2, 1) in good condition?

YES : Go to Step 3.

NO : The wiring harness may be damaged or the connector(s) may have loose, corroded or damaged terminals, or terminals pushed back in the connector. Repair the wiring harness as necessary. Check that the outside transmission antenna assembly (passenger's side) works normally.

STEP 3. Keyless operation system communication test

Check that the communication with the outside transmission antenna assembly (passenger's side) is normal (Refer to Antenna Test P.42B-236).

Antennas to be checked

- Passenger side antenna (exterior)

OK: Normal is displayed.

Q: Is the check result normal?

YES : Go to Step 4.

NO : Replace the outside transmission antenna assembly (passenger's side).

STEP 4. Check whether the diagnostic trouble code is reset.

- (1) Erase the DTC.
- (2) Turn the ignition switch from the LOCK (OFF) position to the ON position.
- (3) Check if the DTC is set.

Q: Is the DTC set?

YES : Replace KOS-ECU and register the ID codes (Refer to P.42B-11).

NO : The procedure is complete.

DTC B240C: Tail gate antenna(outdoor) open

CAUTION

When replacing the ECU, always check that the communication circuit is normal.

Outside Transmission Antenna assembly (Trunk Lid) Circuit

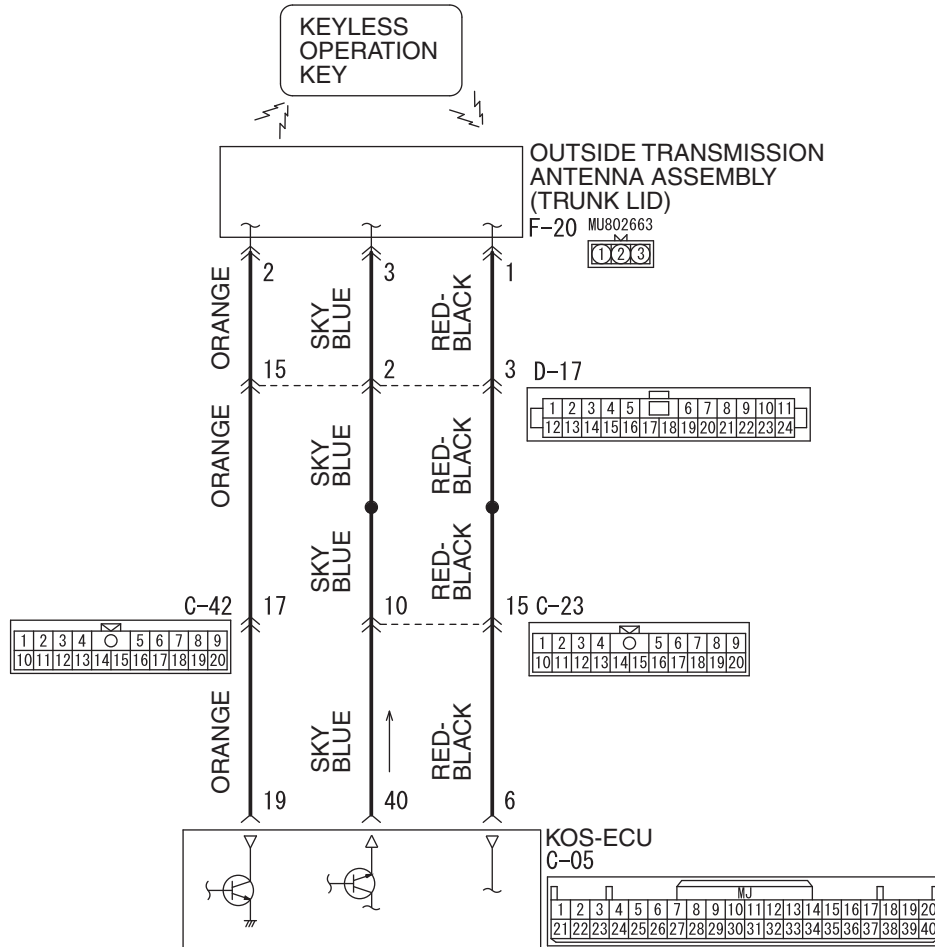

AC609423AJ

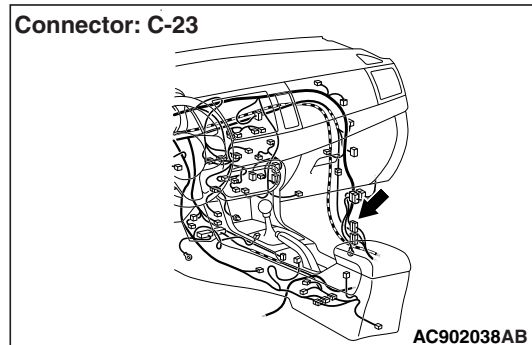
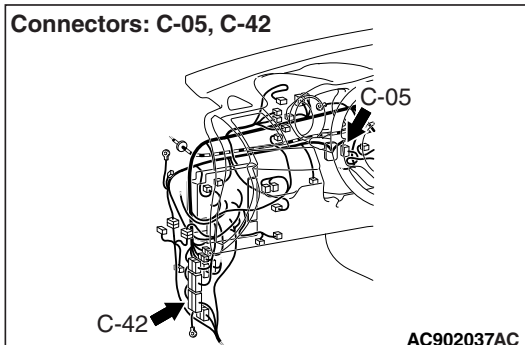

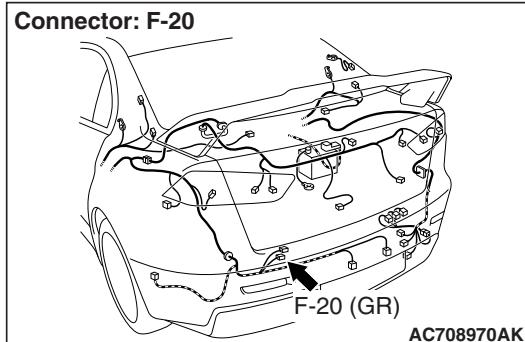
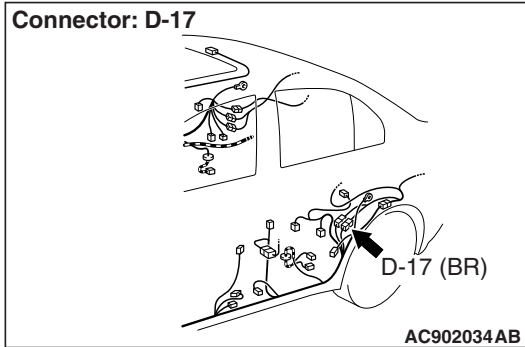

DTC SET CONDITION

If an open circuit is detected in the outside transmission antenna (trunk lid), the DTC is set.

TECHNICAL DESCRIPTION (COMMENT)

When the ignition push switch is pressed, or when the antenna open circuit detection request is received from the diagnosis function, the failure is detected.

TROUBLESHOOTING HINTS

- Malfunction of the outside transmission antenna assembly (trunk lid)
- Malfunction of the KOS-ECU
- Damaged wiring harness and connectors

DIAGNOSIS

STEP 1. Check KOS-ECU connector C-05 and outside transmission antenna assembly (trunk lid) connector F-20 for loose, corroded or damaged terminals, or terminals pushed back in the connector.

Q: Are KOS-ECU connector C-05 and outside transmission antenna assembly (trunk lid) connector F-20 in good condition?

YES : Go to Step 2.

NO : Repair or replace the damaged component(s). Refer to GROUP 00E, Harness Connector Inspection

[P.00E-2](#). Check that the outside transmission antenna assembly (trunk lid) works normally.

STEP 2. Check the wiring harness between KOS-ECU connector C-05 (terminal Nos. 6, 19, 40) and outside transmission antenna assembly (trunk lid) connector F-20 (terminal Nos. 1, 2, 3).

- Check the communication, power supply, and ground wires for open circuit.

NOTE: Also check intermediate connectors C-23, C-42, D-17 for loose, corroded, or damaged terminals, or terminals pushed back in the connector. If intermediate connectors C-23, C-42, D-17 is damaged, repair or replace the damaged component(s) as described in GROUP 00E, Harness Connector Inspection P.00E-2.

Q: Are the wiring harness between KOS-ECU connector C-05 (terminal Nos. 6, 19, 40) and outside transmission antenna assembly (trunk lid) connector F-20 (terminal Nos. 1, 2, 3) in good condition?

YES : Go to Step 3.

NO : The wiring harness may be damaged or the connector(s) may have loose, corroded or damaged terminals, or terminals pushed back in the connector. Repair the wiring harness as necessary. Check that the outside transmission antenna assembly (trunk lid) works normally.

STEP 3. Keyless operation system communication test

Check that the communication with the outside transmission antenna assembly (trunk lid) is normal (Refer to Antenna Test P.42B-236).

Antennas to be checked

Trunk Lid antenna (exterior)

OK: Normal is displayed.

Q: Is the check result normal?

YES : Go to Step 4.

NO : Replace the outside transmission antenna assembly (trunk lid).

STEP 4. Check whether the diagnostic trouble code is reset.

- (1) Erase the DTC.
- (2) Turn the ignition switch from the LOCK (OFF) position to the ON position.
- (3) Check if the DTC is set.

Q: Is the DTC set?

YES : Replace KOS-ECU and register the ID codes (Refer to P.42B-11).

NO : The procedure is complete.

DTC B240D: Front antenna(indoor) open

CAUTION

When replacing the ECU, always check that the communication circuit is normal.

Inside Transmission Antenna assembly (Front) Circuit

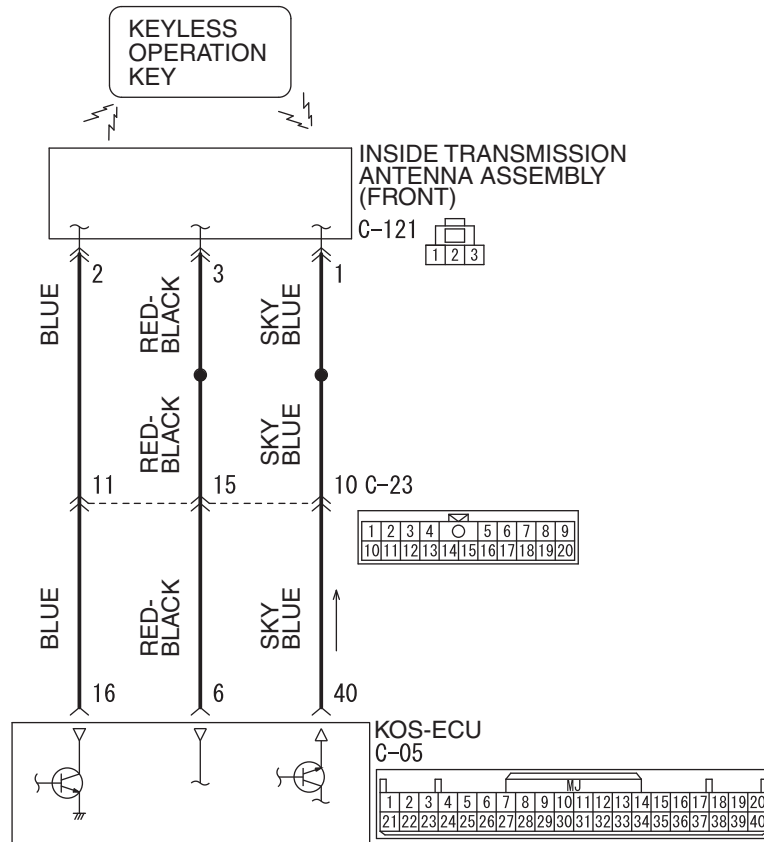

AC609424AC

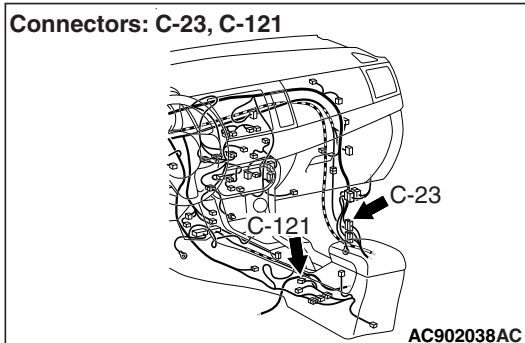
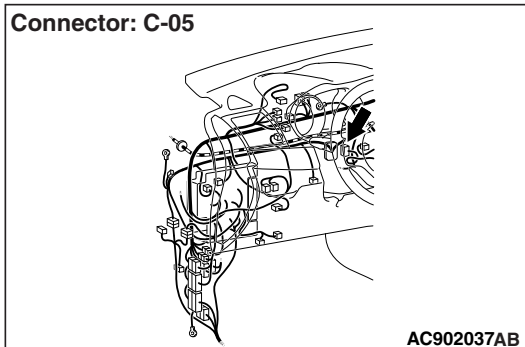

DTC SET CONDITION

If an open circuit is detected in the inside transmission antenna (front), the DTC is set.

TECHNICAL DESCRIPTION (COMMENT)

When the ignition push switch is pressed, or when the antenna open circuit detection request is received from the diagnosis function, the failure is detected.

TROUBLESHOOTING HINTS

- Malfunction of the inside transmission antenna assembly (front)
- Malfunction of the KOS-ECU
- Damaged wiring harness and connectors

DIAGNOSIS

STEP 1. Check KOS-ECU connector C-05 and inside transmission antenna assembly (front) connector C-121 for loose, corroded or damaged terminals, or terminals pushed back in the connector.

Q: Are KOS-ECU connector C-05 and inside transmission antenna assembly (front) connector C-121 in good condition?

YES : Go to Step 2.

NO : Repair or replace the damaged component(s). Refer to GROUP 00E, Harness Connector Inspection [P.00E-2](#). Check that the inside transmission antenna assembly (front) works normally.

STEP 2. Check the wiring harness between KOS-ECU connector C-05 (terminal Nos. 6, 16, 40) and inside transmission antenna assembly (front) connector C-121 (terminal Nos. 3, 2, 1).

- Check the communication, power supply, and ground wires for open circuit.

NOTE: Also check intermediate connector C-23 for loose, corroded, or damaged terminals, or terminals pushed back in the connector. If intermediate connector C-23 is damaged, repair or replace the damaged component(s) as described in GROUP 00E, Harness Connector Inspection [P.00E-2](#).

Q: Are the wiring harness between KOS-ECU connector C-05 (terminal Nos. 6, 16, 40) and inside transmission antenna assembly (front) connector C-121 (terminal Nos. 3, 2, 1) in good condition?

YES : Go to Step 3.

NO : The wiring harness may be damaged or the connector(s) may have loose, corroded or damaged terminals, or terminals pushed back in the connector. Repair the wiring harness as necessary. Check that the inside transmission antenna assembly (front) works normally.

STEP 3. Keyless operation system communication test

Check that the communication with the inside transmission antenna assembly (front) is normal (Refer to Antenna Test [P.42B-236](#)).

Antennas to be checked

- front antenna (interior)

OK: Normal is displayed.

Q: Is the check result normal?

YES : Go to Step 4.

NO : Replace the inside transmission antenna assembly (front).

STEP 4. Check whether the diagnostic trouble code is reset.

- (1) Erase the DTC.
- (2) Turn the ignition switch from the LOCK (OFF) position to the ON position.
- (3) Check if the DTC is set.

Q: Is the DTC set?

YES : Replace KOS-ECU and register the ID codes (Refer to P.42B-11).

NO : The procedure is complete.

Code No.B240E RR antenna(indoor) open

CAUTION

When replacing the ECU, always check that the communication circuit is normal.

Inside Transmission Antenna assembly (Rear) Circuit

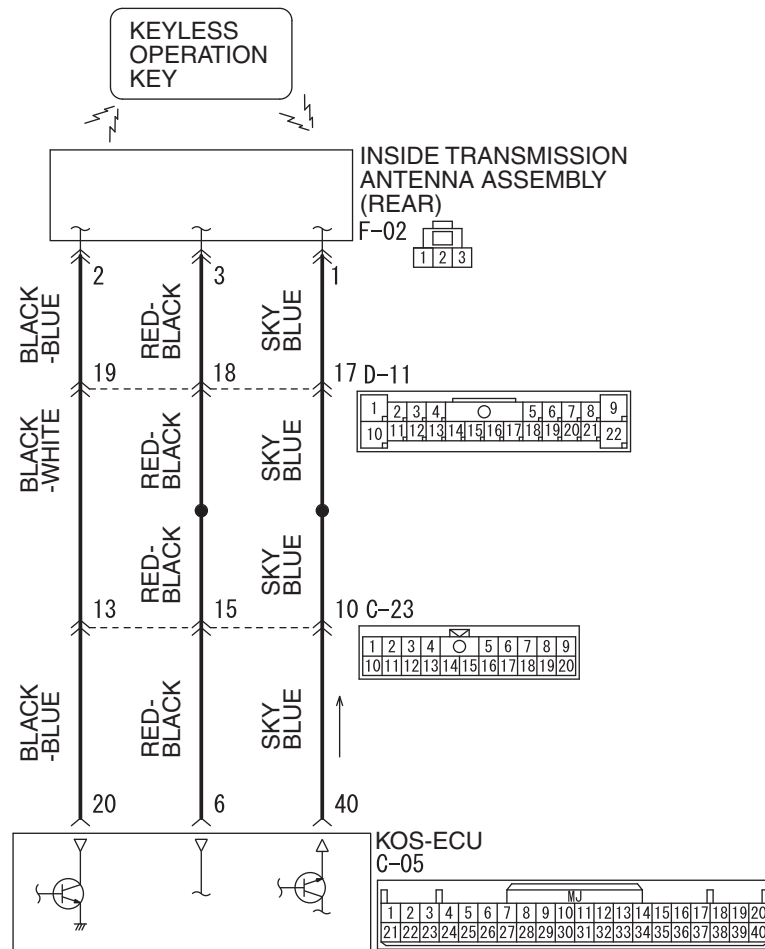

AC609425AC

Connector: C-05

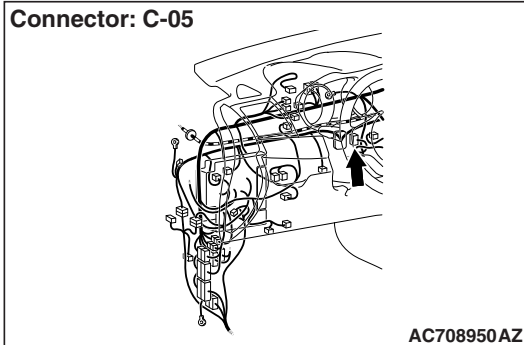

AC708950AZ

Connector: F-02

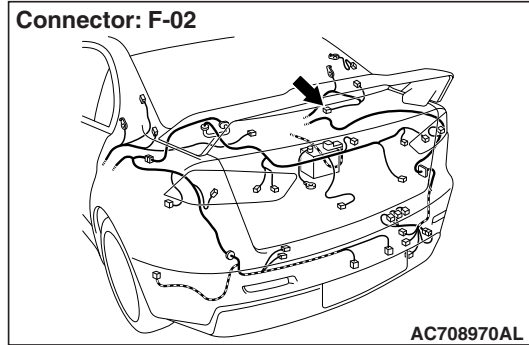

AC708970AL

Connector: C-23

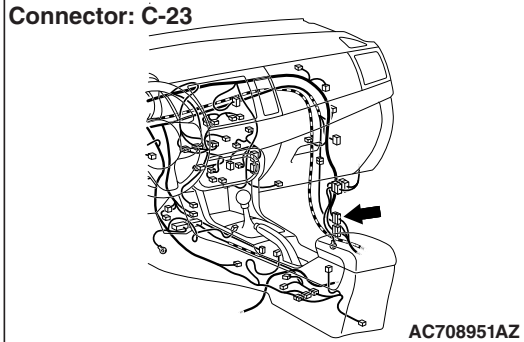

AC708951AZ

Connector: D-11

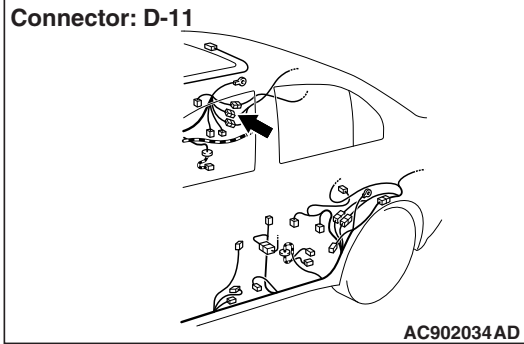

AC902034AD

DTC SET CONDITION

If an open circuit is detected in the inside transmission antenna (rear), the DTC is set.

TECHNICAL DESCRIPTION (COMMENT)

When the ignition push switch is pressed, or when the antenna open circuit detection request is received from the diagnosis function, the failure is detected.

TROUBLESHOOTING HINTS

- Malfunction of the inside transmission antenna assembly (rear)
- Malfunction of the KOS-ECU
- Damaged wiring harness and connectors

DIAGNOSIS

STEP 1. Check KOS-ECU connector C-05 and inside transmission antenna assembly (rear) connector F-02 for loose, corroded or damaged terminals, or terminals pushed back in the connector.

Q: Are KOS-ECU connector C-05 and inside transmission antenna assembly (rear) connector F-02 in good condition?

YES : Go to Step 2.

NO : Repair or replace the damaged component(s). Refer to GROUP 00E, Harness Connector Inspection [P.00E-2](#). Check that the inside transmission antenna assembly (rear) works normally.

STEP 2. Check the wiring harness between KOS-ECU connector C-05 (terminal Nos. 6, 20, 40) and inside transmission antenna assembly (rear) connector F-02 (terminal Nos. 3, 2, 1).

- Check the communication, power supply, and ground wires for open circuit.

NOTE: Also check intermediate connectors C-23, D-11 for loose, corroded, or damaged terminals, or terminals pushed back in the connector. If intermediate connectors C-23, D-11 is damaged, repair or replace the damaged component(s) as described in GROUP 00E, Harness Connector Inspection P.00E-2.

Q: Are the wiring harness between KOS-ECU connector C-05 (terminal Nos. 6, 20, 40) and inside transmission antenna assembly (rear) connector F-02 (terminal Nos. 3, 2, 1) in good condition?

YES : Go to Step 3.

NO : The wiring harness may be damaged or the connector(s) may have loose, corroded or damaged terminals, or terminals pushed back in the connector. Repair the wiring harness as necessary. Check that the inside transmission antenna assembly (rear) works normally.

STEP 3. Keyless operation system communication test

Check that the communication with the inside transmission antenna assembly (rear) is normal (Refer to Antenna Test P.42B-236).

Antennas to be checked

- rear antenna (interior)

OK: Normal is displayed.

Q: Is the check result normal?

YES : Go to Step 4.

NO : Replace the inside transmission antenna assembly (rear).

STEP 4. Check whether the diagnostic trouble code is reset.

- (1) Erase the DTC.
- (2) Turn the ignition switch from the LOCK (OFF) position to the ON position.
- (3) Check if the DTC is set.

Q: Is the DTC set?

YES : Replace KOS-ECU and register the ID codes (Refer to P.42B-11).

NO : The procedure is complete.

DTC B2412: LF antenna power voltage

CAUTION

- If DTC No. B2412 is set, diagnose the CAN bus lines.
- When replacing the ECU, always check that the communication circuit is normal.

Transmission Antenna assembly Circuit

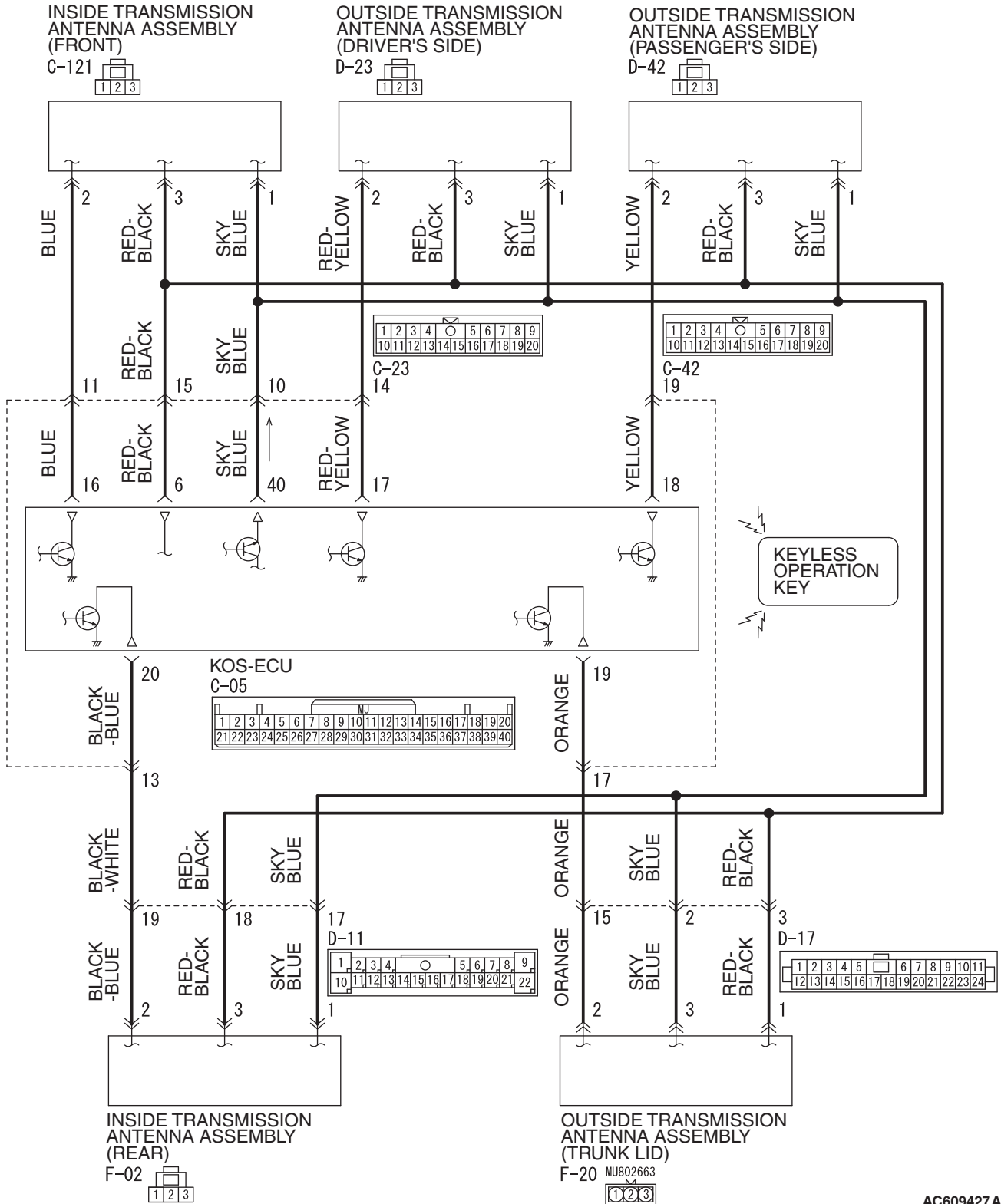

Connector: C-05

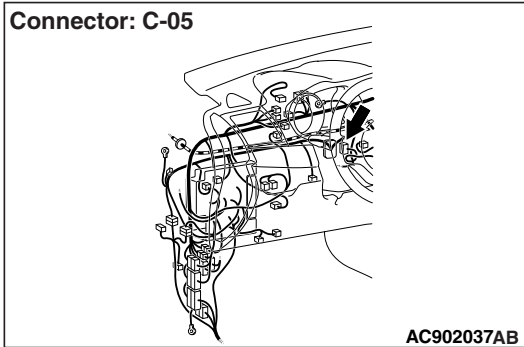

Connector: D-42

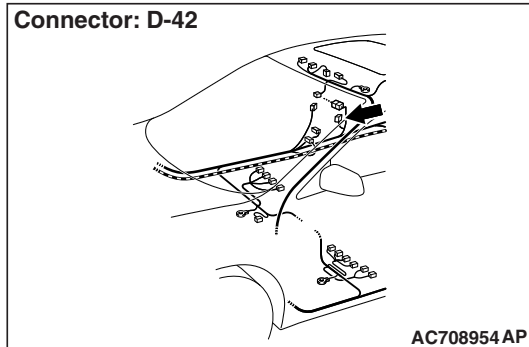

Connectors: C-23, C-121

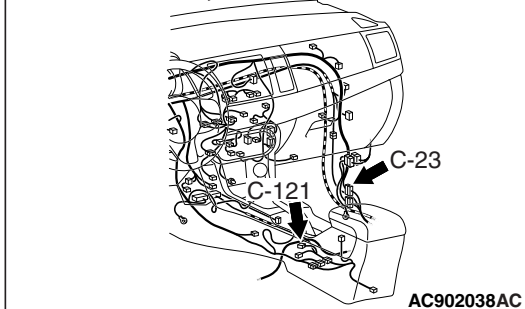

Connectors: F-02, F-20

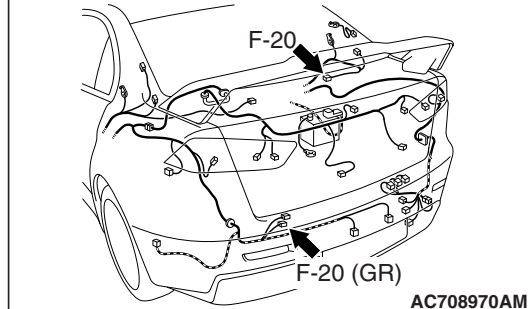

Connectors: D-11, D-17, D-23

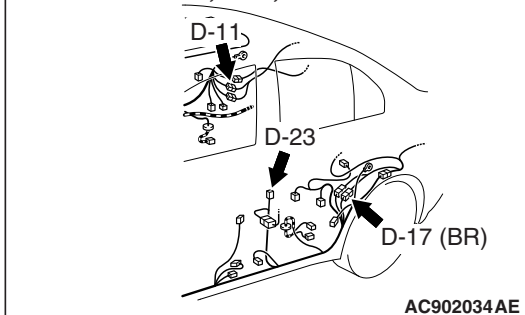

DTC SET CONDITION

If KOS-ECU detects an abnormality in power supply of the outside or inside antennas, KOS-ECU sets the DTC No. B2412.

TECHNICAL DESCRIPTION (COMMENT)

If an abnormality in power supply of the outside or inside transmission antenna is detected when power supply of it is turned on, KOS-ECU determines that there is a problem.

TROUBLESHOOTING HINTS

- Damaged wiring harness and connectors
- Malfunction of the KOS-ECU

DIAGNOSIS

Required Special Tools:

- MB992006: Extra fine probe
- MB991223: Harness set
- MB991958: Scan Tool (M.U.T.-III Sub Assembly)
 - MB991824: Vehicles Communication Interface (V.C.I.)
 - MB991827: M.U.T.-III USB Cable
 - MB991910: M.U.T.-III Main Harness A

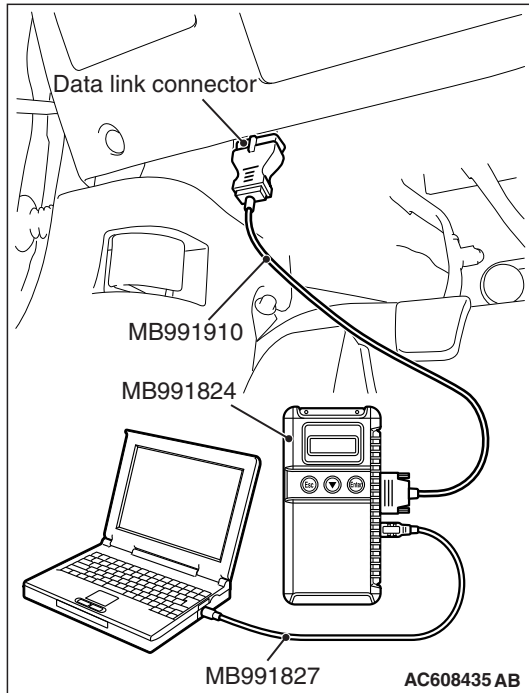

STEP 1. Using scan tool MB991958, read the diagnostic trouble code.

⚠ CAUTION

To prevent damage to scan tool MB991958, always turn the ignition switch to the "LOCK" (OFF) position before connecting or disconnecting scan tool MB991958.

- (1) Connect scan tool MB991958. Refer to "How to connect scan tool (M.U.T.-III) P.42B-9."
- (2) Turn the ignition switch to the "ON" position.
- (3) Check whether the KOS-ECU related DTC is set.
- (4) Turn the ignition switch to the "LOCK" (OFF) position.

Q: Is the DTC set?

YES : Diagnose the KOS-ECU. Refer to P.42B-23.

NO : Go to Step 2.

STEP 2. Check KOS-ECU connector C-05 for loose, corroded or damaged terminals, or terminals pushed back in the connector.

Q: Is KOS-ECU connector C-05 in good condition?

YES : Go to Step 3.

NO : Repair or replace the damaged component(s). Refer to GROUP 00E, Harness Connector Inspection P.00E-2. Check that the inside and outside antenna works normally.

STEP 3. Check the wiring harness between KOS-ECU connector C-05 and each inside and outside antenna.

- Wiring harness between KOS-ECU connector C-05 (terminal No. 40) and outside transmission antenna assembly (driver's side) D-23 connector (terminal No. 1)
- Wiring harness between KOS-ECU connector C-05 (terminal No. 40) and outside transmission antenna assembly (passenger's side) connector D-42 (terminal No. 1)
- Wiring harness between KOS-ECU connector C-05 (terminal No. 40) and inside transmission antenna (front) connector C-121 (terminal No. 1)
- Wiring harness between KOS-ECU connector C-05 (terminal No. 40) and inside transmission antenna (rear) connector F-02 (terminal No. 1)
- Wiring harness between KOS-ECU connector C-05 (terminal No. 40) and outside transmission antenna assembly (trunk lid) connector F-20 (terminal No. 3)

NOTE: Also check intermediate connector C-23, D-11 <inside transmission antenna assembly (rear)>, D-17 <outside transmission antenna assembly (trunk lid)> for loose, corroded, or damaged terminals, or terminals pushed back in the connector. If intermediate connector C-23, D-11 <inside transmission antenna assembly (rear)>, D-17 <outside transmission antenna assembly (trunk lid)> is damaged, repair or replace the damaged component(s) as described in GROUP 00E, Harness Connector Inspection P.00E-2.

Q: Is the check result normal?

YES : Go to Step 4.

NO : Repair the wiring harness.

STEP 4. Check whether the diagnostic trouble code is reset.

- (1) Erase the DTC.
- (2) Turn the ignition switch from the LOCK (OFF) position to the ON position.
- (3) Check if the DTC is set.

Q: Is the DTC set?

YES : Replace KOS-ECU and register the ID codes (Refer to P.42B-11).

NO : The diagnosis is complete.

DTC B2413: STL unit power voltage

CAUTION

- If DTC B2413 is set in the steering lock unit, diagnose the CAN bus lines. If there is any fault in the CAN bus lines, an incorrect diagnostic trouble code may be set. In this case, the set DTC is not highly reliable.
- Whenever the steering lock unit (integrated in the key reminder switch) is replaced, ensure that the communication circuit is normal.

Key Reminder Switch and KOS-ECU Circuit

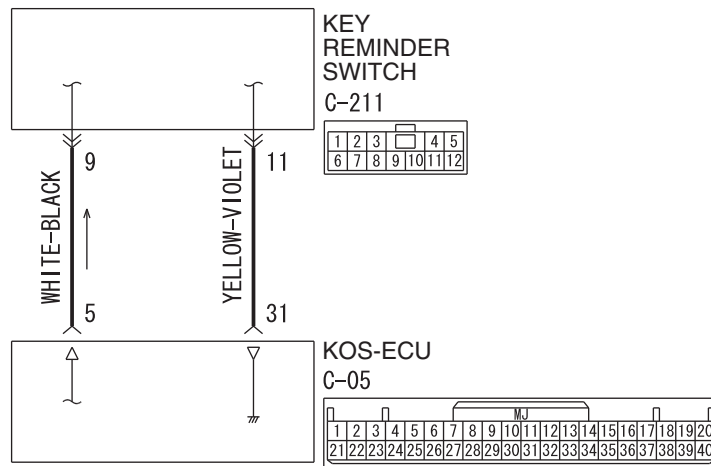

W8G37M003A

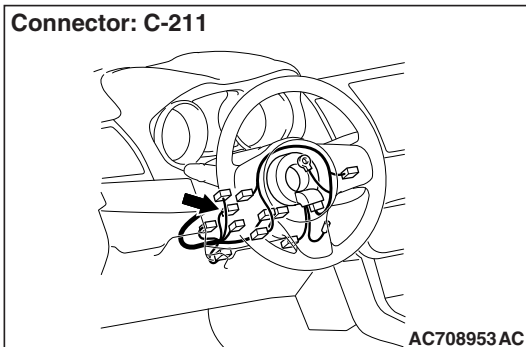
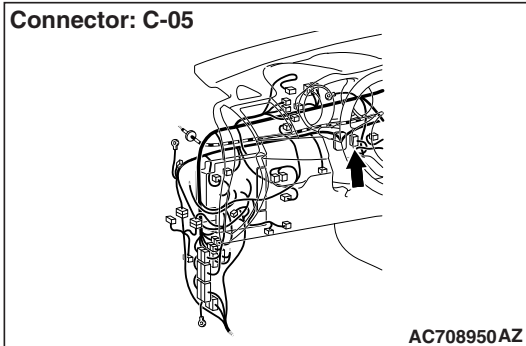

DTC SET CONDITION

If KOS-ECU detects an abnormality in power supply of the steering lock unit, KOS-ECU sets DTC B2413.

TECHNICAL DESCRIPTION (COMMENT)

If an abnormality in power supply of the steering lock unit is detected when power supply of it is turned on, KOS-ECU determines that there is a problem.

TROUBLESHOOTING HINTS

- Damaged wiring harness and connectors
- Malfunction of the steering lock unit (integrated into the key reminder switch)
- Malfunction of the KOS-ECU

DIAGNOSIS

Required Special Tools:

- MB991958: Scan Tool (M.U.T.-III Sub Assembly)
 - MB991824: Vehicles Communication Interface (V.C.I.)
 - MB991827: M.U.T.-III USB Cable
 - MB991910: M.U.T.-III Main Harness A

STEP 1. Using scan tool MB991958, diagnose the CAN bus line.

⚠ CAUTION

To prevent damage to scan tool (MB991958), always turn the ignition switch to the "LOCK" (OFF) position before connecting or disconnecting scan tool (MB991958).

- (1) Connect scan tool MB991958 to the data link connector.
- (2) Turn the ignition switch to the "ON" position.
- (3) Diagnose the CAN bus line.
- (4) Turn the ignition switch to the "LOCK" (OFF) position.

Q: Is the CAN bus line found to be normal?

YES : Go to Step 2.

NO : Repair the CAN bus line (Refer to GROUP 54C, Diagnosis [P.54C-15](#)).

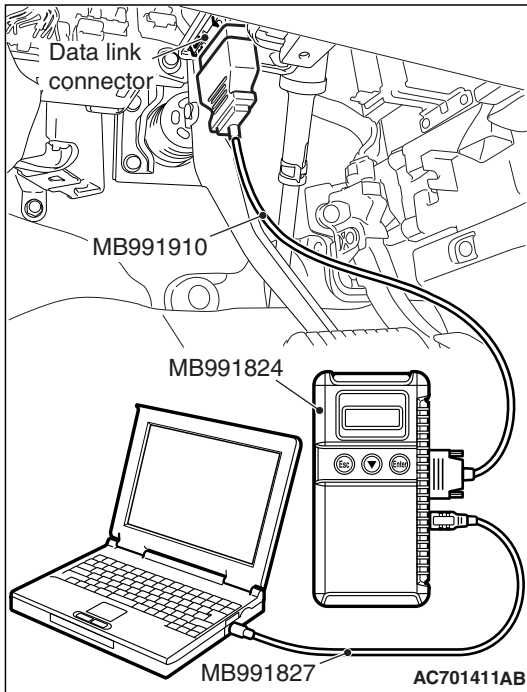

STEP 2. Check key reminder switch connector C-211 for loose, corroded or damaged terminals, or terminals pushed back in the connector.

Q: Is the key reminder switch connector C-211 in good condition?

YES : Go to Step 3.

NO : Repair the defective connector.

STEP 3. Check the power supply circuit to the key reminder switch. Measure the voltage at C-211 key reminder switch connector.

NOTE: Check the power supply line for open circuit and short circuit.

- (1) Disconnect the connector, and measure at the harness side.
- (2) Turn the ignition push switch to the ON position.
- (3) Measure the voltage between the key reminder switch connector terminal No. 9 and ground.

OK: 5 ± 0.5 V

Q: Is the measured voltage 5 ± 0.5 volts?

YES : Go to Step 4.

NO : Check the KOS-ECU connector C-05 and the wiring harness between the KOS-ECU connector C-05 (terminal No. 5) and the key reminder switch connector C-211 (terminal No. 9), and repair them if necessary. If it is normal, replace KOS-ECU and register the ID codes. (Refer to P.42B-11.)

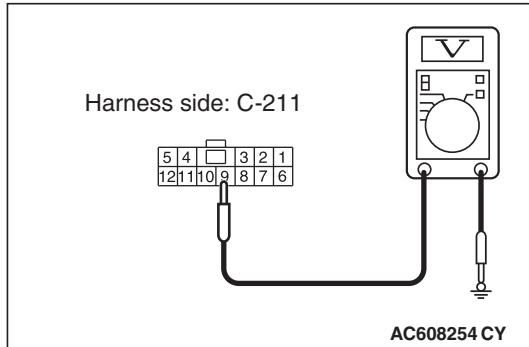

STEP 4. Check KOS-ECU connector C-05 for loose, corroded or damaged terminals, or terminals pushed back in the connector .

Q: Is the KOS-ECU connector C-05 in good condition?

YES : Go to Step 5.

NO : Repair the defective connector.

STEP 5. Check the wiring harness between the C-211 key reminder switch connector (terminal Nos. 11) and the ground for short circuit.

- (1) Disconnect C-211 key reminder switch connector, and check the wiring harness.
- (2) Check the wiring harness between C-211 key reminder switch connector (terminal No.11) and ground

OK: No Continuity

Q: Is the wiring harness between C-211 key reminder switch connector C-211 (terminal No. 11) and the ground in good condition?

YES : Go to Step 6.

NO (key reminder switch connector C-211 terminal No.9 –ground.) : Repair the wiring harness between C-211 key reminder switch connector (terminal No. 11) and the ground.

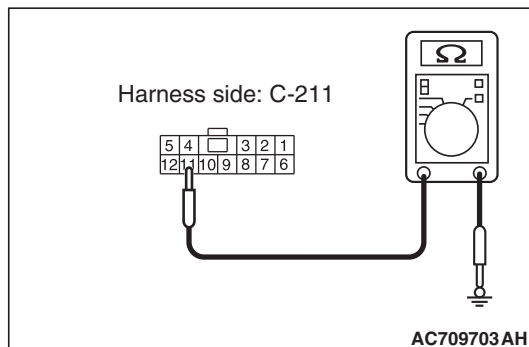

STEP 6. Replace the key reminder switch, and check whether the diagnostic trouble code is reset.

- (1) Erase the DTC.
- (2) Turn the ignition switch from the "LOCK" (OFF) position to the "ON" position.
- (3) Check if the DTC is set.

Q: Is the DTC set?

YES : Replace KOS-ECU and register the ID codes (Refer to P.42B-11).

NO : The procedure is complete.

DTC B2414: Unlock sensor fail

CAUTION

- If DTC No. B2414 is set, diagnose the CAN bus lines.
- When replacing the ECU, always check that the communication circuit is normal.

Unlock Sensor Circuit

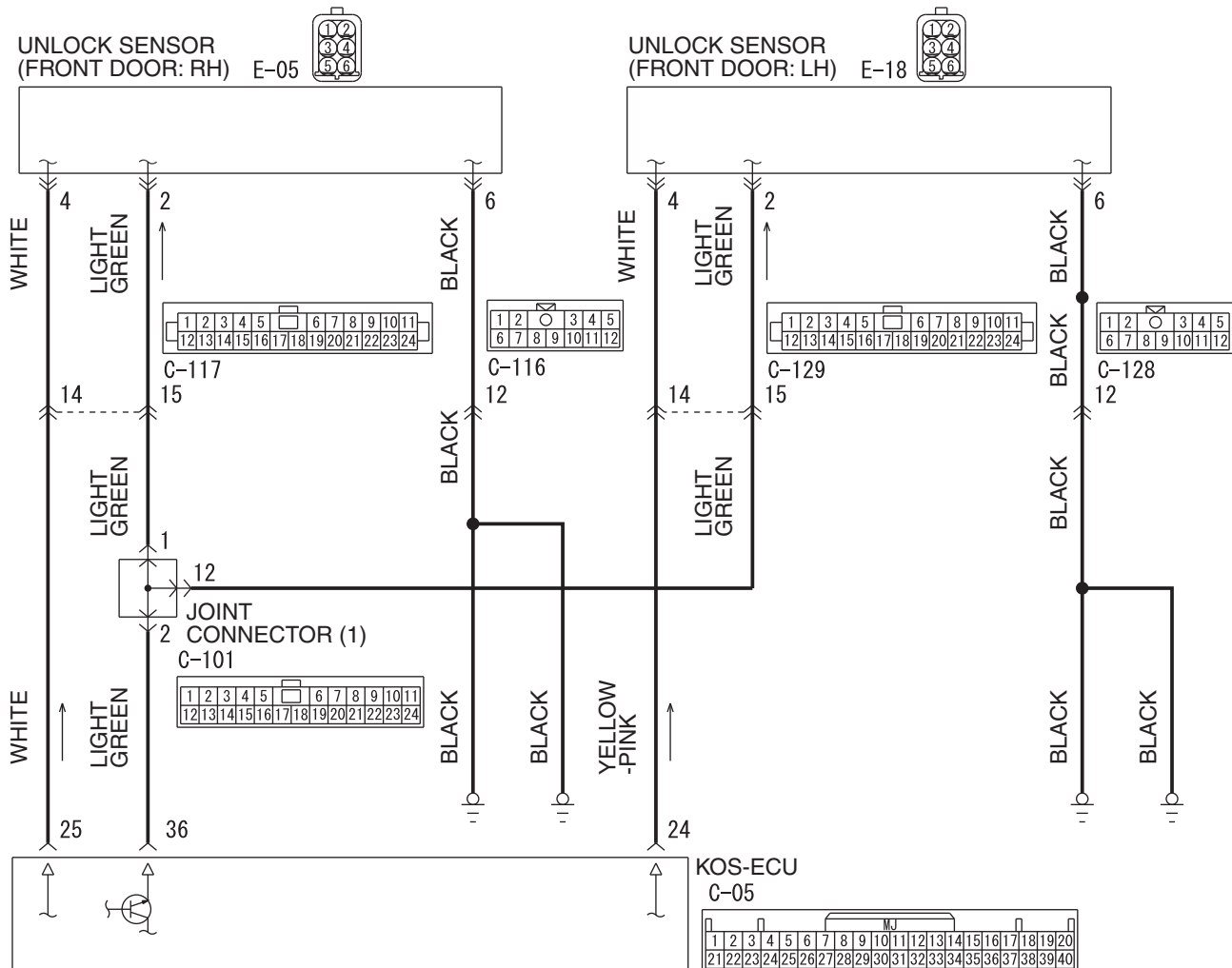

AC901772AB

Connectors: C-05, C-101, C-129

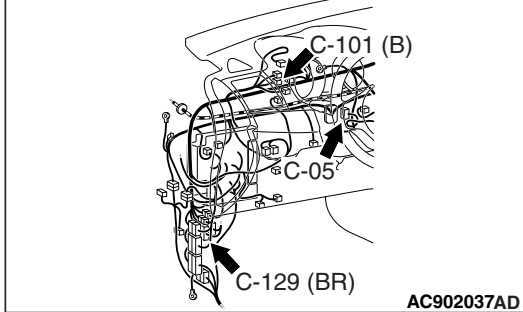

Connector: E-18

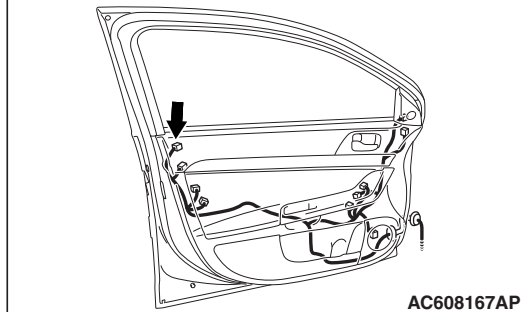

Connector: C-117

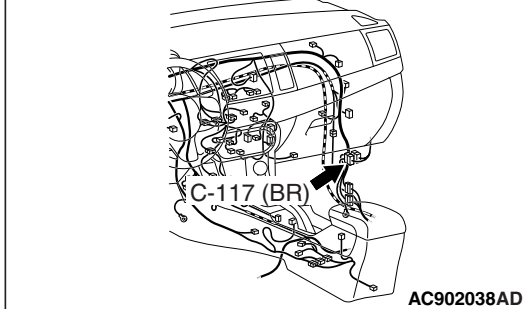

Connector: E-05

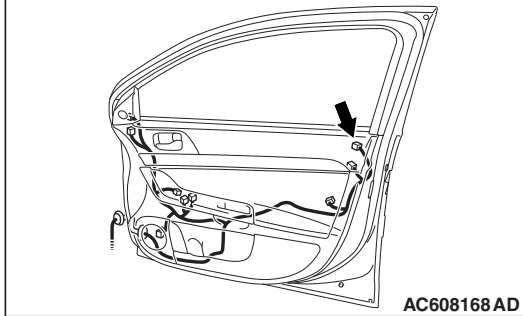
**DTC SET CONDITION**

If KOS-ECU detects an abnormality in power supply of the unlock sensor, KOS-ECU sets DTC No. B2414.

TECHNICAL DESCRIPTION (COMMENT)

If an abnormality in power supply of the unlock sensor is detected when power supply of it is turned on, KOS-ECU determines that there is a problem.

TROUBLESHOOTING HINTS

- Damaged wiring harness and connectors
- Malfunctions of the unlock sensor
- Malfunction of the KOS-ECU

DIAGNOSIS**Required Special Tools:**

- MB992006: Extra fine probe
- MB991223: Harness set
- MB991958: Scan Tool (M.U.T.-III Sub Assembly)
 - MB991824: Vehicles Communication Interface (V.C.I.)
 - MB991827: M.U.T.-III USB Cable
 - MB991910: M.U.T.-III Main Harness A

STEP 1. Using scan tool MB991958, read CAN bus the diagnostic trouble code.

⚠ CAUTION

To prevent damage to scan tool MB991958, always turn the ignition switch to the "LOCK" (OFF) position before connecting or disconnecting scan tool MB991958.

- (1) Connect scan tool MB991958. Refer to "How to connect scan tool (M.U.T.-III) P.42B-9."
- (2) Turn the ignition switch to the "ON" position.
- (3) Check whether the CAN bus lines related DTC is set.
- (4) Turn the ignition switch to the "LOCK" (OFF) position.

Q: Is the DTC set?

YES : Repair the CAN bus line (Refer to GROUP 54C, CAN bus diagnostics table P.54C-15).

NO : Go to Step 2.

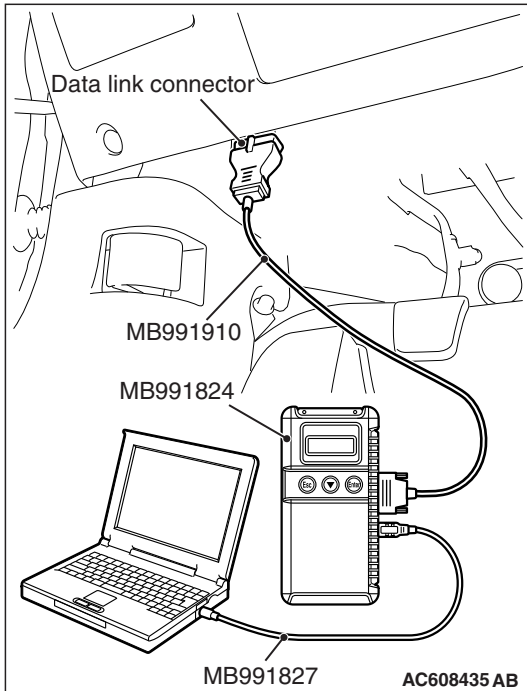

STEP 2. Check KOS-ECU connector C-05, unlock sensor (front door: LH) connector E-18 and unlock sensor (front door: RH) connector E-05 for loose, corroded or damaged terminals, or terminals pushed back in the connector.

Q: Are KOS-ECU connector C-05, unlock sensor (front door: LH) connector E-18 and unlock sensor (front door: RH) connector E-05 in good condition?

YES : Go to Step 3.

NO : Repair or replace the damaged component(s). Refer to GROUP 00E, Harness Connector Inspection P.00E-2. Check that the unlock sensor works normally.

STEP 3. Check the wiring harness between KOS-ECU connector C-05 (terminal Nos. 24 and 36) and unlock sensor (front door: LH) connector E-18 (terminal Nos. 4 and 2).

- Check the power supply and signal wires for open circuit.

NOTE: Also check joint connector (1) C-101, intermediate connector C-129 for loose, corroded, or damaged terminals, or terminals pushed back in the connector. If joint connector (1) C-101, intermediate connector C-129 is damaged, repair or replace the damaged component(s) as described in GROUP 00E, Harness Connector Inspection P.00E-2.

Q: Are the wiring harness between KOS-ECU connector C-05 (terminal Nos. 24 and 36) and unlock sensor (front door: LH) connector E-18 (terminal Nos. 4 and 2) in good condition?

YES : Go to Step 4.

NO : The wiring harness may be damaged or the connector(s) may have loose, corroded or damaged terminals, or terminals pushed back in the connector. Repair the wiring harness as necessary. Check that the unlock sensor works normally.

STEP 4. Check the wiring harness between KOS-ECU connector C-05 (terminal Nos. 25 and 36) and unlock sensor (front door: RH) connector E-05 (terminal Nos. 4 and 2).

- Check the power supply and signal wires for open circuit.

NOTE: Also check joint connector (1) C-101, intermediate connector C-117 for loose, corroded, or damaged terminals, or terminals pushed back in the connector. If joint connector (1) C-101, intermediate connector C-117 is damaged, repair or replace the damaged component(s) as described in GROUP 00E, Harness Connector Inspection P.00E-2.

Q: Are the wiring harness between KOS-ECU connector C-05 (terminal Nos. 25 and 36) and unlock sensor (front door: RH) connector E-05 (terminal Nos. 4 and 2) in good condition?

YES : Go to Step 5.

NO : The wiring harness may be damaged or the connector(s) may have loose, corroded or damaged terminals, or terminals pushed back in the connector. Repair the wiring harness as necessary. Check that the unlock sensor works normally.

STEP 5. Replace the unlock sensor, and check whether the diagnostic trouble code is reset.

- (1) Erase the DTC.
- (2) Turn the ignition switch from the LOCK (OFF) position to the ON position.
- (3) Check if the DTC is set.

Q: Is the DTC set?

YES : Replace KOS-ECU and register the ID codes (Refer to P.42B-11).

NO : The procedure is complete.

DTC B2415: RA module power voltage

CAUTION

- If DTC B2415 is set, diagnose the CAN bus lines.
- When replacing the ECU, always check that the communication circuit is normal.

Receiver Antenna Module and KOS-ECU Circuit

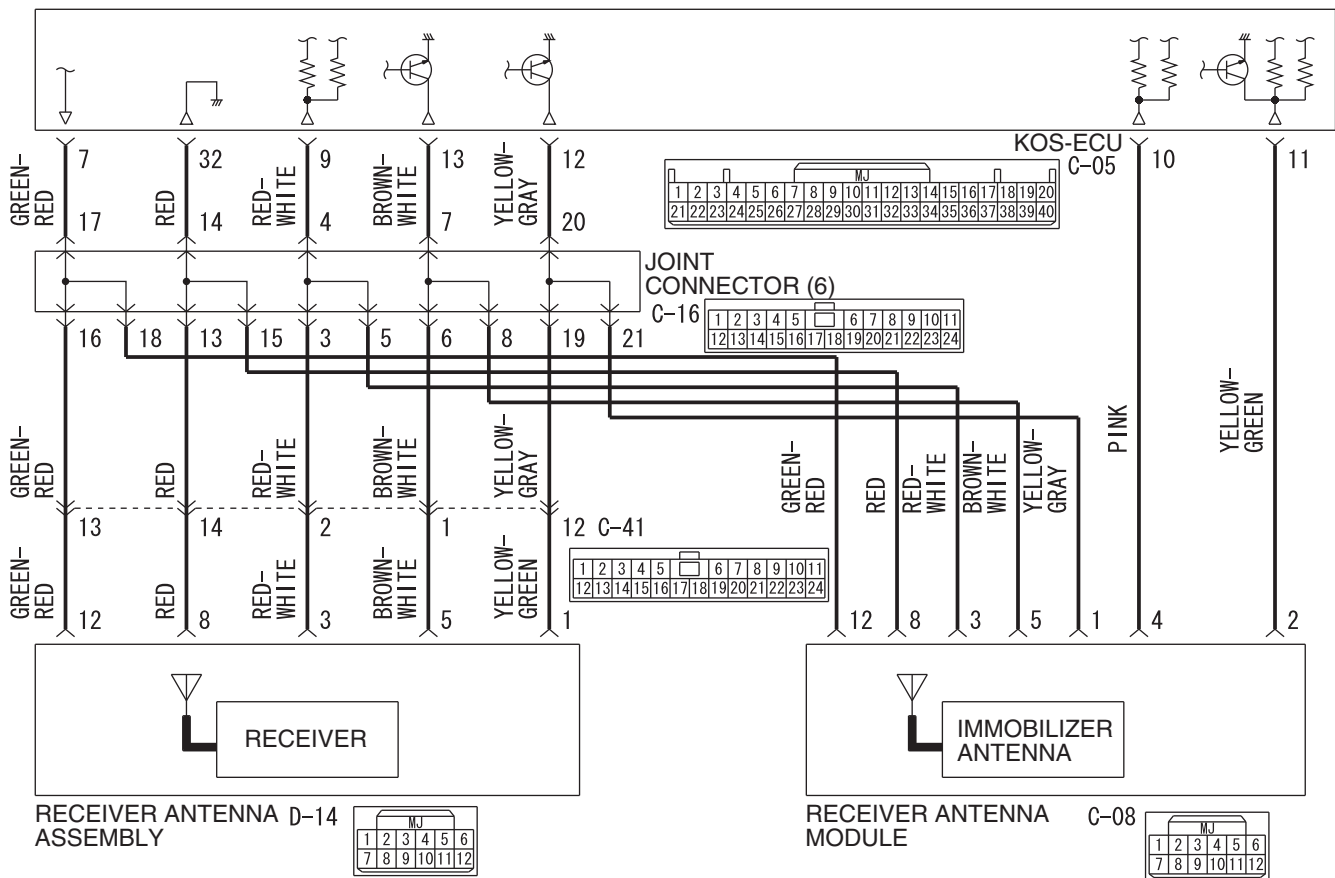

Connectors: C-05, C-41

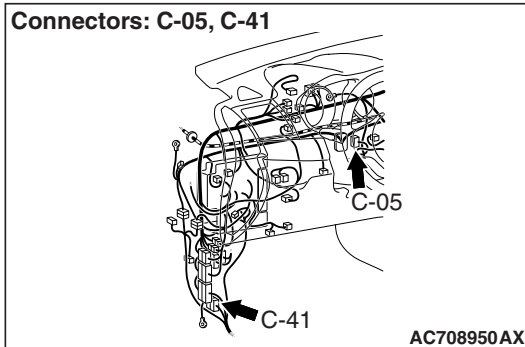

Connectors: C-08, C-16

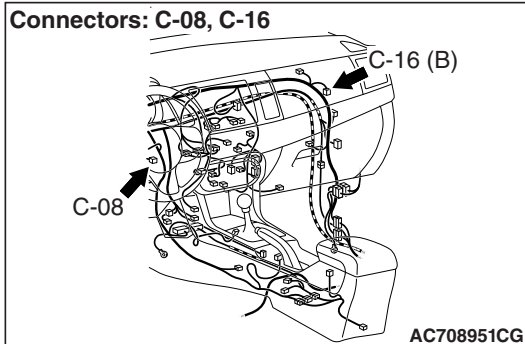

Connector: D-14

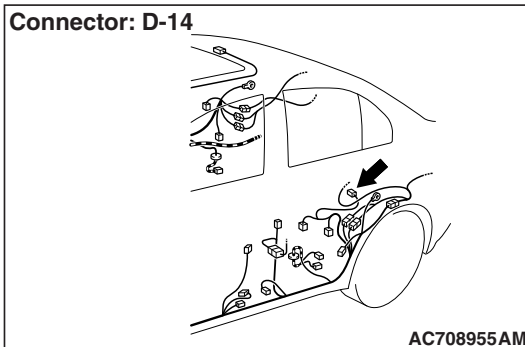
**DTC SET CONDITION**

If KOS-ECU detects an abnormality in power supply of the receiver antenna module or receiver antenna assembly, KOS-ECU sets DTC No. B2415.

TECHNICAL DESCRIPTION (COMMENT)

When the ignition switch is turned to ON, KOS-ECU transmits the signal to the receiver antenna module and receiver antenna assembly. The receiver antenna module and receiver antenna assembly transmits random numbers to the keyless operation key when it receives signals from KOS-ECU. If an open circuit or short to ground occurs on the wiring harness between KOS-ECU and receiver antenna module or receiver antenna assembly at this time, KOS-ECU determines that there is a problem.

TROUBLESHOOTING HINTS

- Malfunction of CAN bus line
- Damaged wiring harness and connectors
- Malfunction of the receiver antenna assembly
- Malfunction of the receiver antenna module
- Malfunction of KOS-ECU

DIAGNOSIS

Required Special Tools:

- MB991958 Scan Tool (M.U.T.-III Sub Assembly)
 - MB991824: Vehicles Communication Interface (V.C.I.)
 - MB991827 M.U.T.-III USB Cable
 - MB991910 M.U.T.-III Main Harness A

STEP 1. Using scan tool MB991958, diagnose the CAN bus line.

⚠ CAUTION

To prevent damage to scan tool (MB991958), always turn the ignition switch to the "LOCK" (OFF) position before connecting or disconnecting scan tool (MB991958).

- (1) Connect scan tool MB991958 to the data link connector.
- (2) Turn the ignition switch to the "ON" position.
- (3) Diagnose the CAN bus line.
- (4) Turn the ignition switch to the "LOCK" (OFF) position.

Q: Is the CAN bus line found to be normal?

YES : Go to Step 2.

NO : Repair the CAN bus line (Refer to GROUP 54C, Diagnosis [P.54C-15](#)).

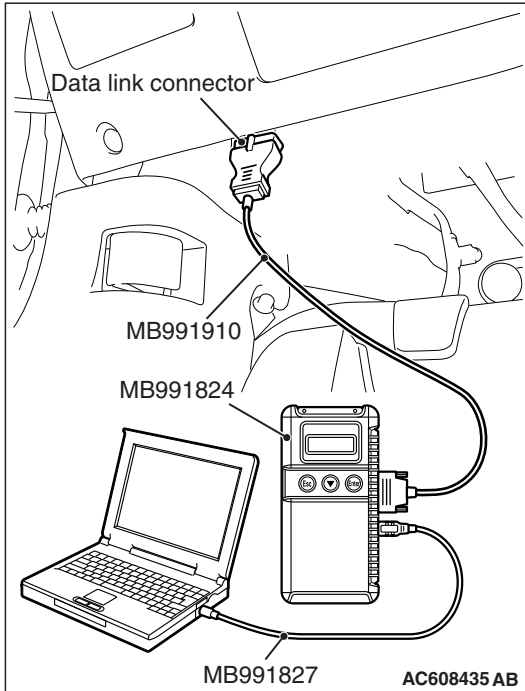

STEP 2. Check receiver antenna module connector C-08, receiver antenna assembly connector D-14, KOS-ECU connector C-05, joint connector (6) C-16 and intermittent connector C-41 for loose, corroded or damaged terminals, or terminals pushed back in the connector.

Q: Is the receiver antenna module connector C-08, receiver antenna assembly connector D-14, KOS-ECU connector C-05, joint connector (6) C-16 and intermittent connector C-41 in good condition?

YES : Go to Step 3.

NO : Repair the defective connector.

STEP 3. Check the wiring harness between the receiver antenna assembly connector D-14 (terminal Nos.1, 8, 12, 3, 5) and the KOS-ECU connector C-05 (terminal Nos.12, 32, 7, 9, 13) for open circuit.

- (1) Disconnect receiver antenna assembly connector D-14 and KOS-ECU connector C-05, and check the wiring harness.
- (2) Check the wiring harness between receiver antenna assembly connector D-14 (terminal No.1) and KOS-ECU connector C-05 (terminal No.12)

OK: Continuity exists (2 Ω or less)

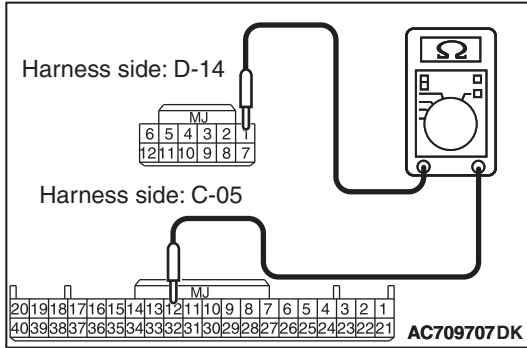

- (3) Check the wiring harness between receiver antenna assembly connector D-14 (terminal No.8) and KOS-ECU connector C-05 (terminal No.32)

OK: Continuity exists (2 Ω or less)

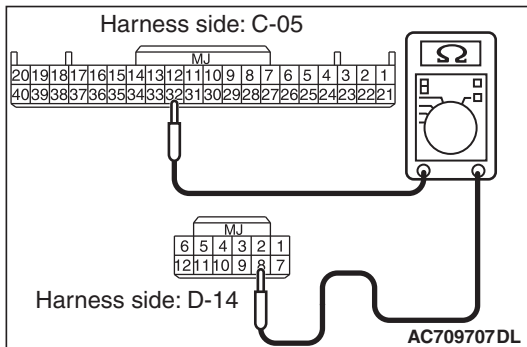

- (4) Check the wiring harness between receiver antenna assembly connector D-14 (terminal No.12) and KOS-ECU connector C-05 (terminal No.7)

OK: Continuity exists (2 Ω or less)

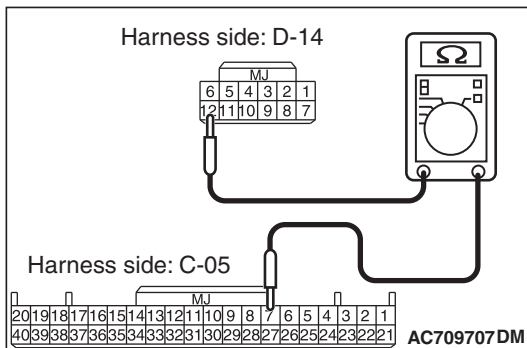

- (5) Check the wiring harness between receiver antenna assembly connector D-14 (terminal No.3) and KOS-ECU connector C-05 (terminal No.9)

OK: Continuity exists (2 Ω or less)

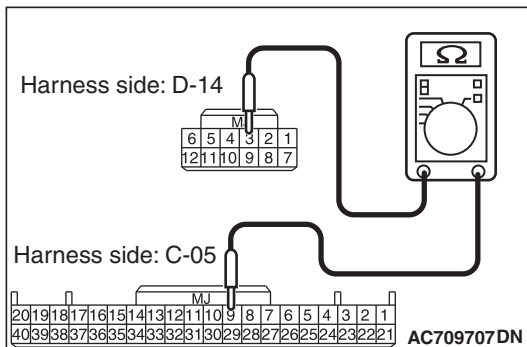

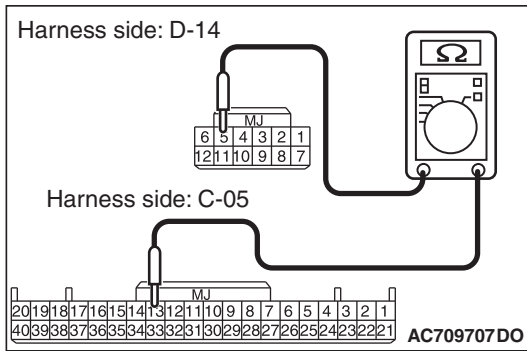

- (6) Check the wiring harness between receiver antenna assembly connector D-14 (terminal No.5) and KOS-ECU connector C-05 (terminal No.13)

OK: Continuity exists (2 Ω or less)

Q: Is the wiring harness between receiver antenna assembly connector D-14 (terminal Nos.1, 8, 12, 3, 5) and the KOS-ECU connector C-05 (terminal Nos.12, 32, 7, 9, 13) in good condition?

YES : Go to Step 4.

NO (receiver antenna assembly connector D-14 terminal No.1 –KOS-ECU connector C-05 terminal No.12.) :

Repair the wiring harness between receiver antenna assembly connector D-14 (terminal No.1) and the KOS-ECU connector C-05 (terminal No.12).

NO (receiver antenna assembly connector D-14 terminal No.8 –KOS-ECU connector C-05 terminal No.32.) :

Repair the wiring harness between receiver antenna assembly connector D-14 (terminal No.8) and the KOS-ECU connector C-05 (terminal No.32).

NO (receiver antenna assembly connector D-14 terminal No.12 –KOS-ECU connector C-05 terminal No.7.) :

Repair the wiring harness between receiver antenna assembly connector D-14 (terminal No.12) and the KOS-ECU connector C-05 (terminal No.7).

NO (receiver antenna assembly connector D-14 terminal No.3 –KOS-ECU connector C-05 terminal No.9.) :

Repair the wiring harness between receiver antenna assembly connector D-14 (terminal No.3) and the KOS-ECU connector C-05 (terminal No.9).

NO (receiver antenna assembly connector D-14 terminal No.5 –KOS-ECU connector C-05 terminal No.13.) :

Repair the wiring harness between receiver antenna assembly connector D-14 (terminal No.5) and the KOS-ECU connector C-05 (terminal No.13).

STEP 4. Check the wiring harness between the receiver antenna assembly connector D-14 (terminal Nos.1, 8, 12, 3, 5) and the ground for short circuit.

(1) Disconnect receiver antenna assembly connector D-14, and check the wiring harness.

(2) Check the wiring harness between receiver antenna assembly connector D-14 (terminal No.1) and ground

OK: No continuity

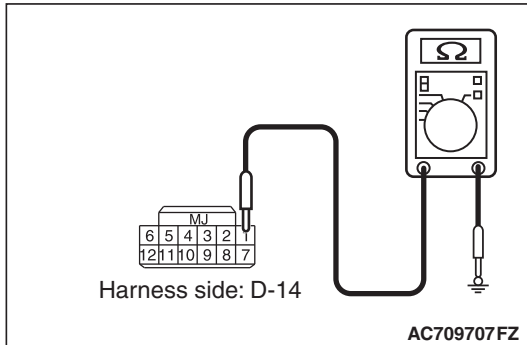

(3) Check the wiring harness between receiver antenna assembly connector D-14 (terminal No.8) and ground

OK: No continuity

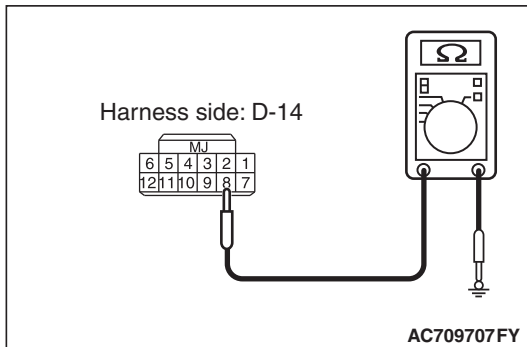

(4) Check the wiring harness between receiver antenna assembly connector D-14 (terminal No.12) and ground

OK: No continuity

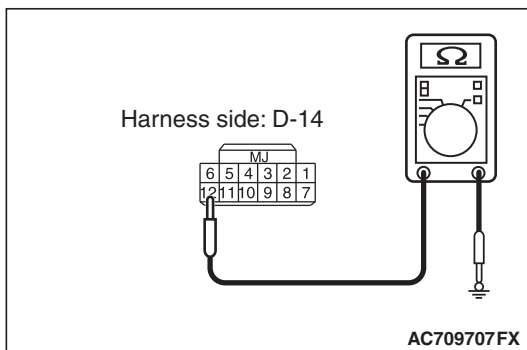

(5) Check the wiring harness between receiver antenna assembly connector D-14 (terminal No.3) and ground

OK: No continuity

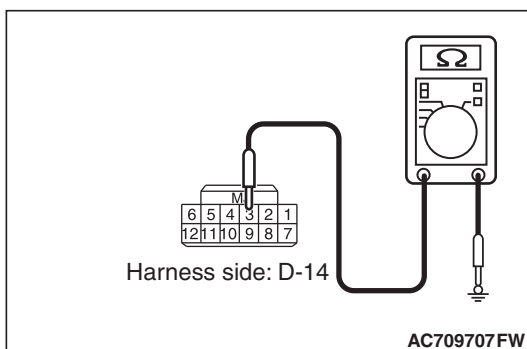

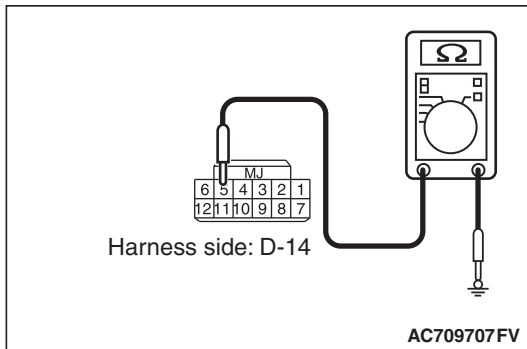

- (6) Check the wiring harness between receiver antenna assembly connector D-14 (terminal No.5) and ground

OK: No continuity

Q: Is the wiring harness between receiver antenna assembly connector D-14 (terminal Nos.1, 8, 12, 3, 5) and the ground in good condition?

YES : Go to Step 5.

NO (receiver antenna assembly connector D-14 terminal No.1 –ground.) : Repair the wiring harness between receiver antenna assembly connector D-14 (terminal No.1) and the KOS-ECU connector C-05 (terminal No.12).

NO (receiver antenna assembly connector D-14 terminal No.8 –ground.) : Repair the wiring harness between receiver antenna assembly connector D-14 (terminal No.8) and the ground.

NO (receiver antenna assembly connector D-14 terminal No.12 –ground.) : Repair the wiring harness between receiver antenna assembly connector D-14 (terminal No.12) and the ground.

NO (receiver antenna assembly connector D-14 terminal No.3 –ground.) : Repair the wiring harness between receiver antenna assembly connector D-14 (terminal No.3) and the ground.

NO (receiver antenna assembly connector D-14 terminal No.5 –ground.) : Repair the wiring harness between receiver antenna assembly connector D-14 (terminal No.5) and the ground.

STEP 5. Replace the receiver antenna assembly, and check whether the diagnostic trouble code is reset.

- (1) Turn the ignition switch from the "LOCK" (OFF) position to the "ON" position.
(2) Check if the DTC is set.

Q: Is the DTC set?

YES : Go to Step 6.

NO : The procedure is complete.

STEP 6. Check the wiring harness between the receiver antenna module connector C-08 (terminal Nos. 2, 1, 8, 12) and the KOS-ECU connector C-05 (terminal Nos. 11, 12, 32, 7) for open circuit.

- (1) Disconnect receiver antenna module connector C-08 and KOS-ECU connector C-05, and check the wiring harness.
- (2) Check the wiring harness between receiver antenna module connector C-08 (terminal No.2) and KOS-ECU connector C-05 (terminal No.11)

OK: Continuity exists (2 Ω or less)

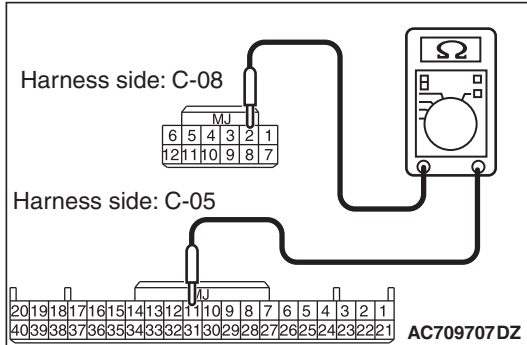

- (3) Check the wiring harness between receiver antenna module connector C-08 (terminal No.1) and KOS-ECU connector C-05 (terminal No.12)

OK: Continuity exists (2 Ω or less)

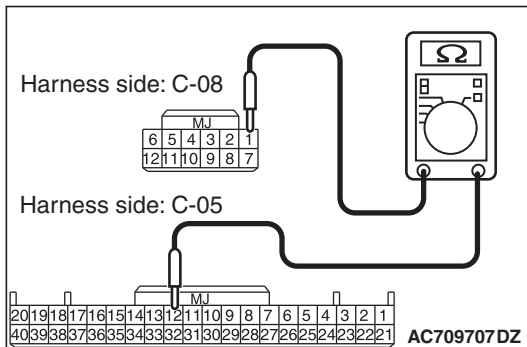

- (4) Check the wiring harness between receiver antenna module connector C-08 (terminal No.8) and KOS-ECU connector C-05 (terminal No.32)

OK: Continuity exists (2 Ω or less)

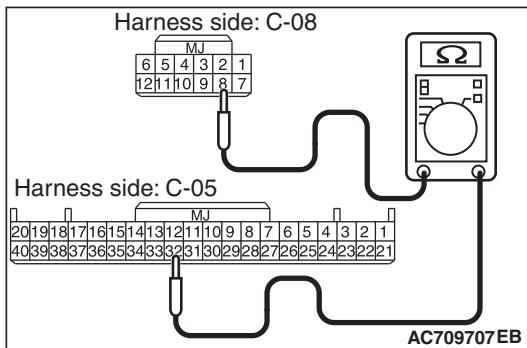

- (5) Check the wiring harness between receiver antenna module connector C-08 (terminal No.12) and KOS-ECU connector C-05 (terminal No.7)

OK: Continuity exists (2 Ω or less)

Q: Is the wiring harness between receiver antenna module connector C-08 (terminal Nos. 2, 1, 8, 12) and the KOS-ECU connector C-05 (terminal Nos. 11, 12, 32, 7) in good condition?

YES : Go to Step 7.

NO (receiver antenna module connector C-08 terminal No.2 –KOS-ECU connector C-05 terminal No.11.) :

Repair the wiring harness between receiver antenna module connector C-08 (terminal No. 2) and the KOS-ECU connector C-05 (terminal No. 11).

NO (receiver antenna module connector C-08 terminal No.1 –KOS-ECU connector C-05 terminal No.12.) :

Repair the wiring harness between receiver antenna module connector C-08 (terminal No. 1) and the KOS-ECU connector C-05 (terminal No. 12).

NO (receiver antenna module connector C-08 terminal No.8 –KOS-ECU connector C-05 terminal No.32.) :

Repair the wiring harness between receiver antenna module connector C-08 (terminal No. 8) and the KOS-ECU connector C-05 (terminal No. 32).

NO (receiver antenna module connector C-08 terminal No.12 –KOS-ECU connector C-05 terminal No.7.) :

Repair the wiring harness between receiver antenna module connector C-08 (terminal No. 12) and the KOS-ECU connector C-05 (terminal No. 7).

STEP 7. Check the wiring harness between the receiver antenna module connector C-08 (terminal Nos. 2, 1, 8, 12) and the ground for short circuit.

- (1) Disconnect receiver antenna module connector C-08, and check the wiring harness.
- (2) Check the wiring harness between receiver antenna module connector C-08 (terminal No.2) and ground

OK: No continuity

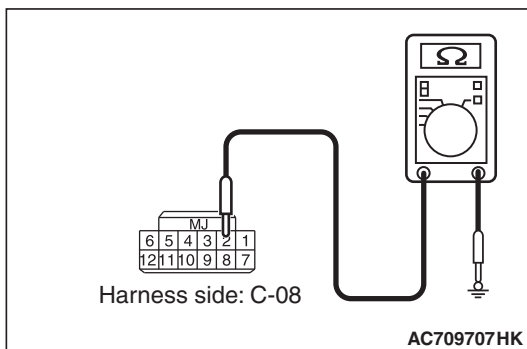

- (3) Check the wiring harness between receiver antenna module connector C-08 (terminal No.1) and ground

OK: No continuity

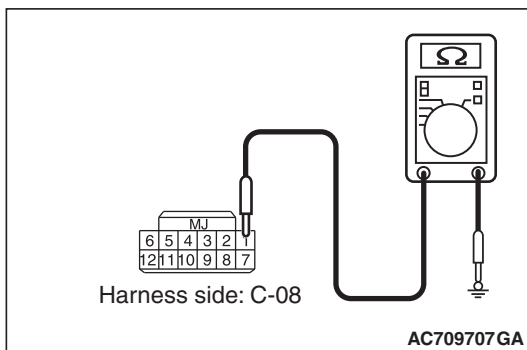

- (4) Check the wiring harness between receiver antenna module connector C-08 (terminal No.8) and ground

OK: No continuity

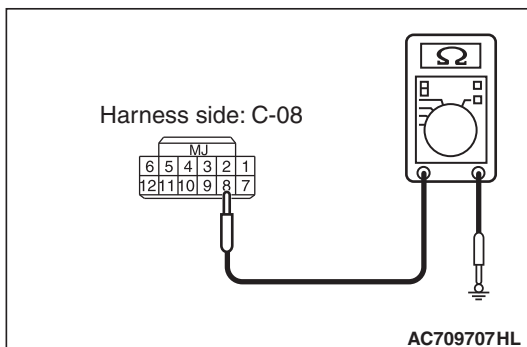

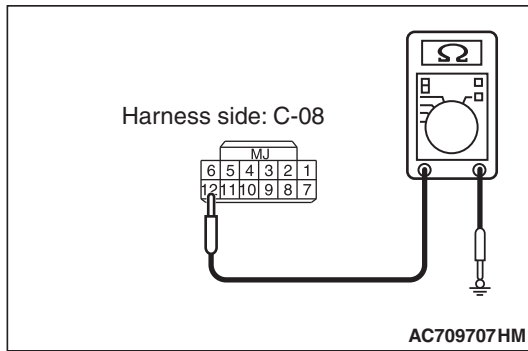

- (5) Check the wiring harness between receiver antenna module connector C-08 (terminal No.12) and ground

OK: No continuity

Q: Is the wiring harness between receiver antenna module connector C-08 (terminal Nos. 2, 1, 8, 12) and the ground in good condition?

YES : Go to Step 8.

NO (receiver antenna module connector C-08 terminal No.2 –ground.) : Repair the wiring harness between receiver antenna module connector C-08 (terminal No. 2) and the ground.

NO (receiver antenna module connector C-08 terminal No.1 –ground.) : Repair the wiring harness between receiver antenna module connector C-08 (terminal No. 1) and the ground.

NO (receiver antenna module connector C-08 terminal No.8 –ground.) : Repair the wiring harness between receiver antenna module connector C-08 (terminal No. 8) and the ground.

NO (receiver antenna module connector C-08 terminal No.12 –ground.) : Repair the wiring harness between receiver antenna module connector C-08 (terminal No. 12) and the ground.

STEP 8. Replace the receiver antenna module, and check whether the diagnostic trouble code is reset.

- (1) Turn the ignition switch from the "LOCK" (OFF) position to the "ON" position.
- (2) Check if the DTC is set.

Q: Is the DTC set?

YES : Replace KOS-ECU and register the ID codes (Refer to P.42B-11).

NO : The procedure is complete.

DTC B2416: ECU internal error

DTC SET CONDITION

KOS-ECU sets DTC B2416 when it determines itself to be in abnormal status.

TECHNICAL DESCRIPTION (COMMENT)

KOS-ECU determines that the abnormality is present, if the data abnormality is found when the ignition switch is turned ON and then EEPROM is written.

TROUBLESHOOTING HINTS

Malfunction of KOS-ECU

DIAGNOSIS

Required Special Tools:

- MB991958: Scan Tool (M.U.T.-III Sub Assembly)
 - MB991824: Vehicles Communication Interface (V.C.I.)
 - MB991827: M.U.T.-III USB Cable
 - MB991910: M.U.T.-III Main Harness A

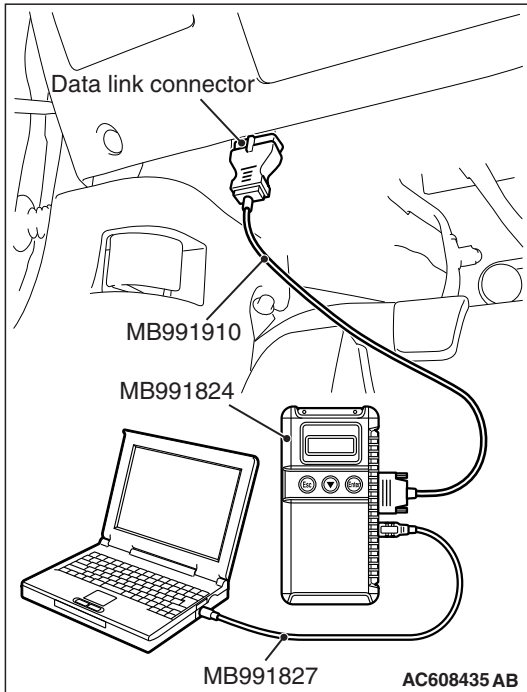

Recheck for diagnostic trouble code.

Check again if the DTC is set to the KOS-ECU.

⚠ CAUTION

To prevent damage to scan tool (MB991958), always turn the ignition switch to the "LOCK" (OFF) position before connecting or disconnecting scan tool (MB991958).

- (1) Connect scan tool MB991958 to the data link connector.
- (2) Erase the DTC.
- (3) Turn the ignition switch from "LOCK" (OFF) position to "ON" position.
- (4) Check if DTC is set.
- (5) Turn the ignition switch to the "LOCK" (OFF) position.

Q: Is the DTC set?

- YES :** Replace KOS-ECU and register the ID codes (Refer to P.42B-11).
- NO :** The trouble can be an intermittent malfunction (Refer to GROUP 00 –How to use Troubleshooting/inspection Service Points –How to Cope with Intermittent Malfunction P.00-15).

DTC C1608: EEPROM Error

⚠ CAUTION

If there is any problem in the CAN bus lines, an incorrect diagnostic trouble code may be set. Prior to this diagnosis, diagnose the CAN bus lines (Refer to GROUP 54C, Trouble code diagnosis P.54C-15).

DTC SET CONDITION

KOS incorporates EEPROM (nonvolatile memory), and that EEPROM stores the TPMS, KOS and immobilizer information. When the data in EEPROM is failed, this code is set.

TROUBLESHOOTING HINTS

The most likely causes for this DTC to set are:

- Damaged wiring harness and connector
- Malfunction of KOS-ECU

DIAGNOSIS

Required Special Tools:

- MB991958 Scan Tool (M.U.T.-III Sub Assembly)
 - MB991824: Vehicle Communication Interface (V.C.I.)
 - MB991827 M.U.T.-III USB Cable
 - MB991910 M.U.T.-III Main Harness A

STEP 1. Using scan tool MB991958, diagnose the CAN bus lines.

Use scan tool to diagnose the CAN bus lines.

Q: Is the check result normal?

YES : Go to Step 2.

NO : Repair the CAN bus lines (Refer to GROUP 54C – CAN Bus Diagnostics table P.54C-9). On completion, go to Step 2.

STEP 2. Diagnostic trouble code check

(1) Turn the ignition switch to the "LOCK" (OFF) position.

(2) Turn the ignition switch to the "ON" position.

(3) Check if the DTC is set.

(4) Turn the ignition switch to the "LOCK" (OFF) position.

Q: Is the DTC C1608 set?

YES : Replace the KOS-ECU and register the ID codes (Refer to P.42B-227). Then go to Step 3.

NO : The procedure is complete.

STEP 3. Diagnostic trouble code check

(1) Turn the ignition switch to the "LOCK" (OFF) position.

(2) Turn the ignition switch to the "ON" position.

(3) Check if the DTC is set.

(4) Turn the ignition switch to the "LOCK" (OFF) position.

Q: Is the DTC C1608 set?

YES : Start over at Step 1.

NO : The procedure is complete.

DTC C1900: No registration

⚠ CAUTION

If there is any problem in the CAN bus lines, an incorrect diagnostic trouble code may be set. Prior to this diagnosis, diagnose the CAN bus lines (Refer to GROUP 54C, Trouble code diagnosis P.54C-15).

DTC SET CONDITION

When the ID registration information of the TPMS transmitter is not stored in KOS-ECU, and/or when KOS-ECU is replaced with a new one, this code is set. If the ID registration mode is terminated forcibly or time-out after one or more TPMS transmitters are registered in the ID registration mode, the ID information in the KOS-ECU is erased, and this diagnostic trouble code is set.

TROUBLESHOOTING HINTS

The most likely causes for this DTC to set are:

- Damaged wiring harness and connector
- Malfunction of TPMS transmitter
- Malfunction of KOS-ECU
- ID code registration failed

DIAGNOSIS

Required Special Tools:

- MB991958: Scan Tool (M.U.T.-III Sub Assembly)
 - MB991824: Vehicle Communication Interface (V.C.I.)
 - MB991827: M.U.T.-III USB Cable
 - MB991910: M.U.T.-III Main Harness A

STEP 1. Using scan tool MB991958, diagnose the CAN bus line.

Use scan tool to diagnose the CAN bus lines.

Q: Is the check result normal?

YES : Go to Step 2.

NO : Repair the CAN bus lines (Refer to GROUP 54C – CAN Bus Diagnostics table [P.54C-15](#)). On completion, go to Step 2.

STEP 2. Diagnostic trouble code check

- (1) Turn the ignition switch to the "LOCK" (OFF) position.
- (2) Turn the ignition switch to the "ON" position.
- (3) Check if the DTC is set.
- (4) Turn the ignition switch to the "LOCK" (OFF) position.

Q: Is the DTC C1900 set?

YES : Register the ID codes (Refer to [P.42B-227](#)). Then go to Step 3.

NO : The procedure is complete.

STEP 3. Recheck for diagnostic trouble code.

Check again if the DTC is set.

- (1) Turn the ignition switch to the "LOCK" (OFF) position.
- (2) Turn the ignition switch to the "ON" position.
- (3) Check if the DTC is set.
- (4) Turn the ignition switch to the "LOCK" (OFF) position.

Q: Is the DTC C1900 reset?

YES : Replace the KOS-ECU and register the ID codes (Refer to [P.42B-11](#)). Then start over at Step 1.

NO : The procedure is complete.

DTC C1901: Vehicle speed information abnormality

⚠ CAUTION

If there is any problem in the CAN bus lines, an incorrect diagnostic trouble code may be set. Prior to this diagnosis, diagnose the CAN bus lines (Refer to GROUP 54C, Trouble code diagnosis [P.54C-15](#)).

DTC SET CONDITION

KOS-ECU receives the wheel speed information from ASC-ECU via the CAN-bus line. Although KOS-ECU receives the information that the wheel is not currently rotated from ASC-ECU, if the TPMS transmitter sends the information that the wheel is rotated, this code is set.

TROUBLESHOOTING HINTS

The most likely causes for this DTC to set are:

- Damaged wiring harness and connector
- Malfunction of TPMS transmitter
- Malfunction of KOS-ECU
- Malfunction of ASC-ECU
- Malfunction of ETACS-ECU

DIAGNOSIS**Required Special Tools:**

- MB991958: Scan Tool (M.U.T.-III Sub Assembly)
 - MB991824: Vehicle Communication Interface (V.C.I.)
 - MB991827: M.U.T.-III USB Cable
 - MB991910: M.U.T.-III Main Harness A

STEP 1. Using scan tool MB991958, diagnose the CAN bus lines.

Use scan tool to diagnose the CAN bus lines.

Q: Is the check result normal?

YES : Go to Step 3.

NO : Repair the CAN bus lines (Refer to GROUP 54C – CAN Bus Diagnostics table [P.54C-269](#)). On completion, go to Step 2.

STEP 2. Diagnostic trouble code recheck after resetting CAN bus lines

- (1) Turn the ignition switch to the "LOCK" (OFF) position.
- (2) Turn the ignition switch to the "ON" position.
- (3) Check if the DTC is set.
- (4) Turn the ignition switch to the "LOCK" (OFF) position.

Q: Is the DTC C1901 set?

YES : Go to Step 3.

NO : The procedure is complete.

STEP 3. Check for other diagnostic trouble code.

Check if the diagnostic trouble code is set from ASC-ECU (Refer to GROUP 35C, diagnostic trouble code chart [P.35C-22](#)).

Q: Is the check result normal?

YES : Go to Step 4.

NO : Carry out the troubleshooting for ASC-ECU (Refer to GROUP 35C, diagnostic trouble code chart [P.35C-22](#)). Then go to Step 6.

STEP 4. Check for other diagnostic trouble code.

Check if the diagnostic trouble code is set from ETACS-ECU (Refer to GROUP 54A, ETACS –diagnostic trouble code chart [P.54A-646](#)).

Q: Is the check result normal?

YES : Go to Step 5.

NO : Troubleshoot the set DTC (Refer to GROUP 54A, ETACS –diagnostic trouble code chart [P.54A-646](#)). Then go to Step 6.

STEP 5. Check the TPMS transmitter acceleration.

Check the acceleration value of each TPMS transmitter by the air pressure of data list (Refer to [P.42B-150](#)).

OK:

Acceleration value: 5G or less

Q: Is the check result OK?

YES : Replace the KOS-ECU and register ID codes (Refer to [P.42B-11](#)). Then go to Step 6.

NO : Replace the TPMS transmitter and register ID codes (Refer to [P.42B-11](#)). Then go to Step 6.

STEP 6. Recheck for diagnostic trouble code.

- (1) Turn the ignition switch to the "LOCK" (OFF) position.
- (2) Turn the ignition switch to the "ON" position.
- (3) Check if the DTC is set.
- (4) Turn the ignition switch to the "LOCK" (OFF) position.

Q: Is the DTC C1901 set?

YES : Start over at Step 1.

NO : The procedure is complete.

- DTC C1910: Transmitter low battery voltage abnormality 1
- DTC C1920: Transmitter low battery voltage abnormality 2
- DTC C1930: Transmitter low battery voltage abnormality 3
- DTC C1940: Transmitter low battery voltage abnormality 4
- DTC C1911: Reception abnormality 1
- DTC C1921: Reception abnormality 2
- DTC C1931: Reception abnormality 3
- DTC C1941: Reception abnormality 4

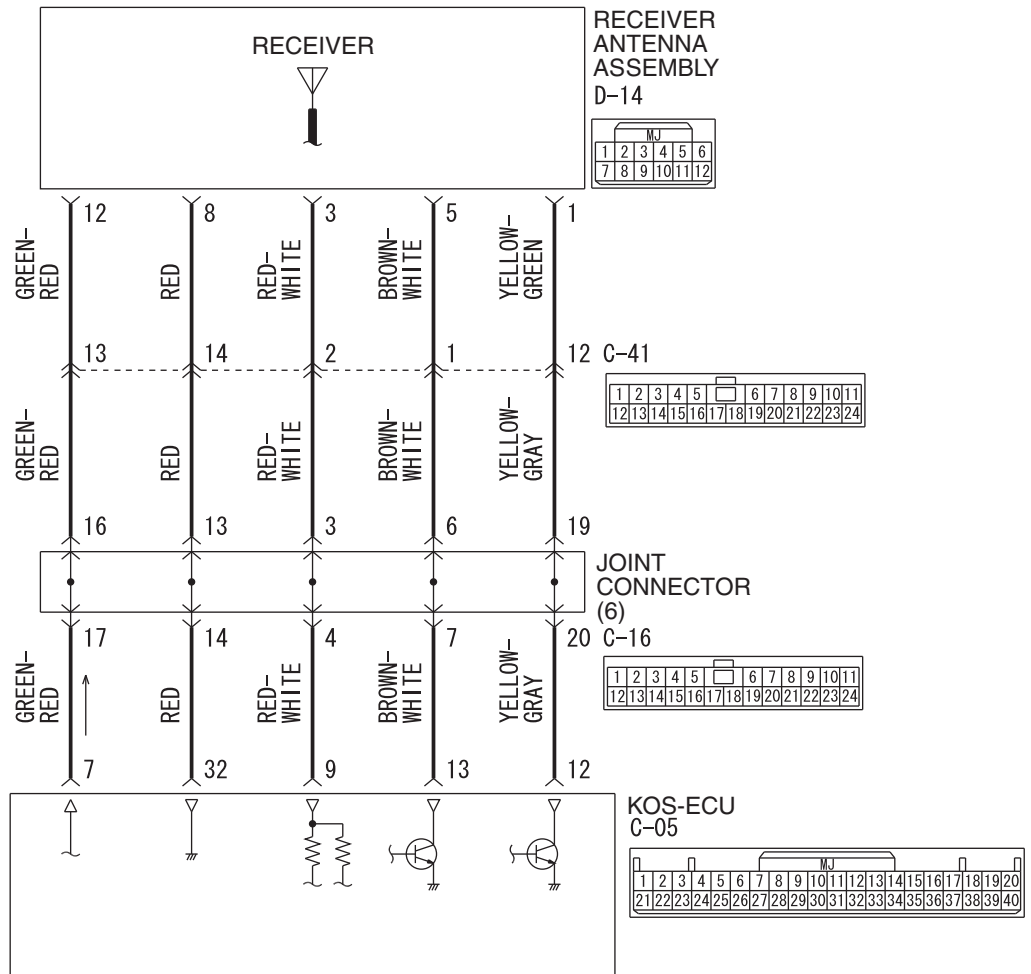

AC709590

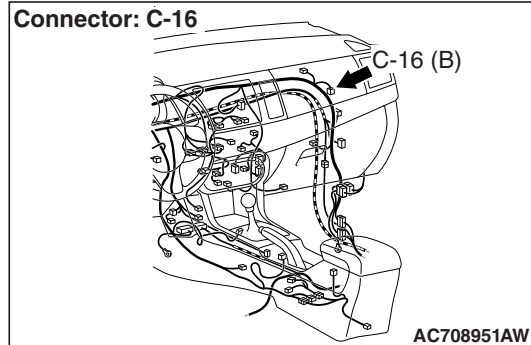
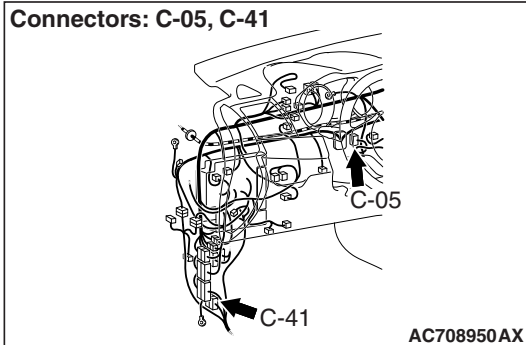

⚠ CAUTION

If there is any problem in the CAN bus lines, an incorrect diagnostic trouble code may be set. Prior to this diagnosis, diagnose the CAN bus lines (Refer to GROUP 54C, Trouble code diagnosis [P.54C-15](#)).

DTC SET CONDITION

DTC C1910, C1920, C1930, C1940

- When the reception abnormality warning is activated because of the low battery voltage of the TPMS transmitter.

DTC C1911, C1921, C1931, C1941

- When KOS-ECU cannot receive the signals from the TPMS transmitters while driving for about 20 minutes, this code is set.

TROUBLESHOOTING HINTS

The most likely causes for this DTC to set are:

- Low battery that is incorporated into the TPMS transmitter
- Damaged wiring harness and connector
- Registered IDs unmatched
- Malfunction of Receiver antenna assembly
- Malfunction of TPMS transmitter
- Malfunction of KOS-ECU

DIAGNOSIS

Required Special Tools:

- MB991958 Scan Tool (M.U.T.-III Sub Assembly)
 - MB991824: Vehicle Communication Interface (V.C.I.)
 - MB991827 M.U.T.-III USB Cable
 - MB991910 M.U.T.-III Main Harness A

STEP 1. Using scan tool MB991958, diagnose the CAN bus lines.

Use scan tool to diagnose the CAN bus lines.

Q: Is the check result normal?

YES : Go to Step 3.

NO : Repair the CAN bus lines (Refer to GROUP 54C – CAN Bus Diagnostics table [P.54C-269](#)). On completion, go to Step 2.

STEP 2. Diagnostic trouble code recheck after resetting CAN bus lines

Q: Is the DTC C1910, C1920, C1930, C1940, C1911, C1921, C1931 or C1941 set?

YES (When DTC C1911, C1921, C1931 and C1941 are set) : Go to Step 3.

YES (When DTC C1911, C1921, C1931 or C1941 is set) : Go to Step 7.

YES (When DTC C1910, C1920, C1930, C1940, C1911, C1921, C1931 and C1941 are set) : Replace all TPMS transmitters, and then register the ID codes. (Refer to [P.42B-227.](#)) Then go to Step 8.

NO : The procedure is complete.

STEP 3. Connector check: C-05 KOS-ECU connector, C-16 joint connector, C-41 intermediate connector, and D-14 receiver antenna assembly connector

Q: Is the check result normal?

YES : Go to Step 4.

NO : Repair or replace the defective connector, and then register the ID codes. (Refer to [P.42B-227.](#)) Then go to Step 8.

STEP 4. Wiring harness check between C-05 KOS-ECU connector and D-14 receiver antenna assembly connector.

- (1) Disconnect C-05 KOS-ECU connector and D-14 receiver antenna assembly connector.
- (2) Measure at the harness connector side of the D-14 receiver antenna assembly.
- (3) Measure the resistance between the D-14 receiver antenna assembly terminals.

- Terminal No.1 –body ground.

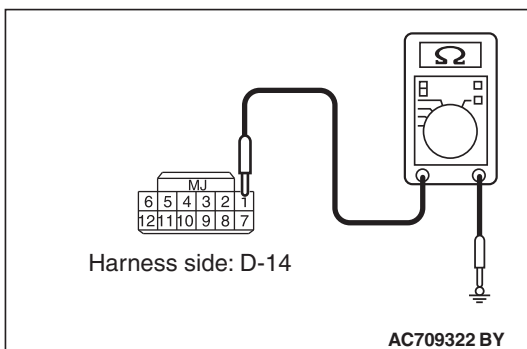

- Terminal No.3 –body ground.

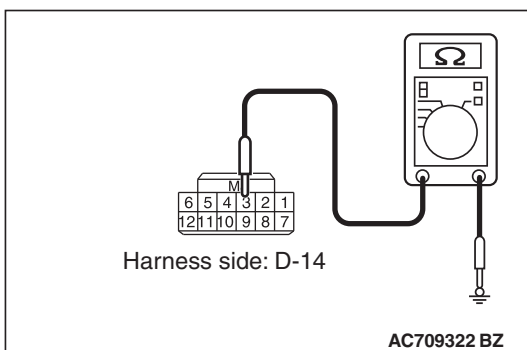

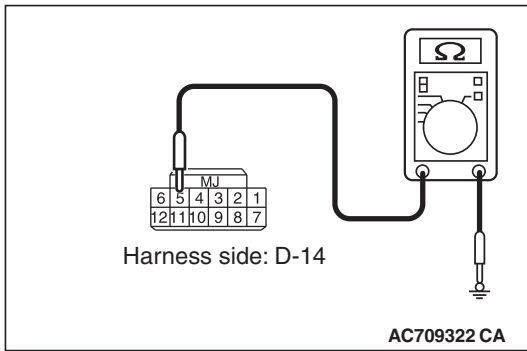

- Terminal No.5 –body ground.

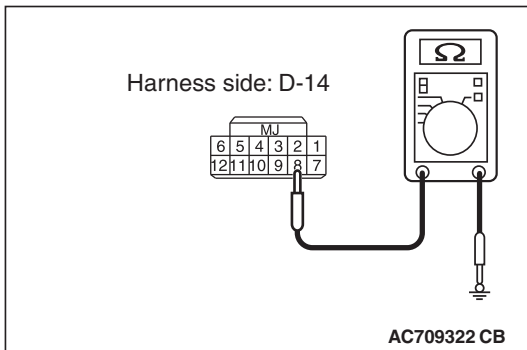

- Terminal No.8 –body ground.

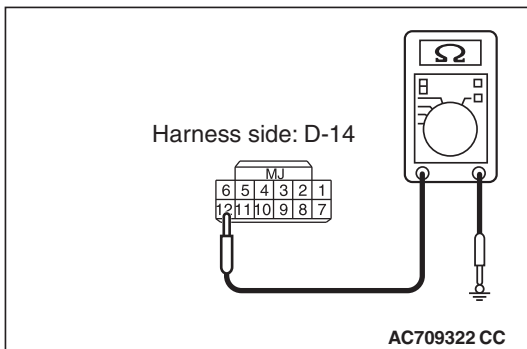

- Terminal No.12 –body ground.

OK: No continuity

Q: Is the check result normal?

YES : Go to Step 5.

NO (terminal No.1 –body ground.) : The wiring harness between D-14 receiver antenna assembly connector terminal No.1 and C-05 KOS-ECU connector terminal No.12 is shorted to ground. Repair the wiring harness, and then register the ID codes. (Refer to [P.42B-227.](#)) Then go to Step 8.

NO (terminal No.3 –body ground.) : The wiring harness between D-14 receiver antenna assembly connector terminal No.3 and C-05 KOS-ECU connector terminal No.9 is shorted to ground. Repair the wiring harness, and then register the ID codes. (Refer to [P.42B-227.](#)) Then go to Step 8.

NO (terminal No.5 –body ground.) : The wiring harness between D-14 receiver antenna assembly connector terminal No.5 and C-05 KOS-ECU connector terminal No.13 is shorted to ground. Repair the wiring harness, and then register the ID codes. (Refer to [P.42B-227.](#)) Then go to Step 8.

NO (terminal No.8 –body ground.) : The wiring harness between D-14 receiver antenna assembly connector terminal No.8 and C-05 KOS-ECU connector terminal No.32 is shorted to ground. Repair the wiring harness, and then register the ID codes. (Refer to [P.42B-227.](#)) Then go to Step 8.

NO (terminal No.12 –body ground.) : The wiring harness between D-14 receiver antenna assembly connector terminal No.12 and C-05 KOS-ECU connector terminal No.7 is shorted to ground. Repair the wiring harness, and then register the ID codes. (Refer to [P.42B-227.](#)) Then go to Step 8.

STEP 5. Wiring harness check between C-05 KOS-ECU connector and D-14 receiver antenna assembly connector.

- (1) Disconnect C-05 KOS-ECU connector and D-14 receiver antenna assembly connector.
- (2) Measure at the harness connector side of C-05 KOS-ECU connector and D-14 receiver antenna assembly connector.
- (3) Measure the resistance between the terminals.
 - C-05 KOS-ECU connector terminal No.7 –D-14 receiver antenna assembly connector terminal No.12.

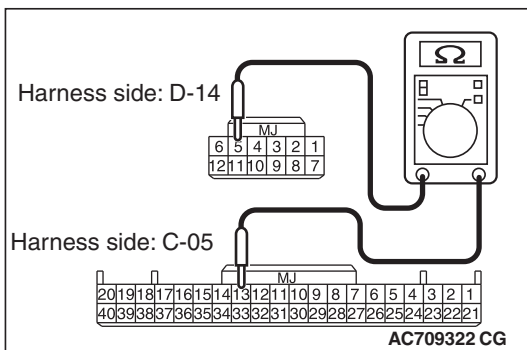
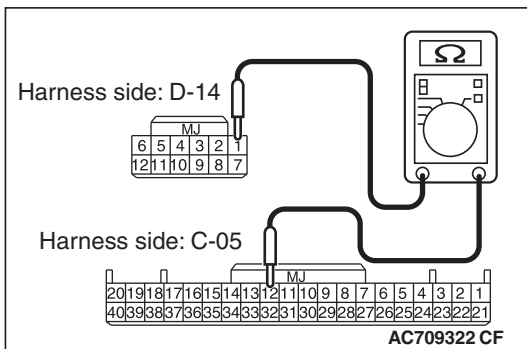
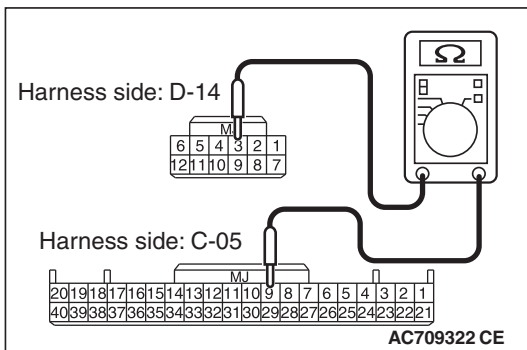
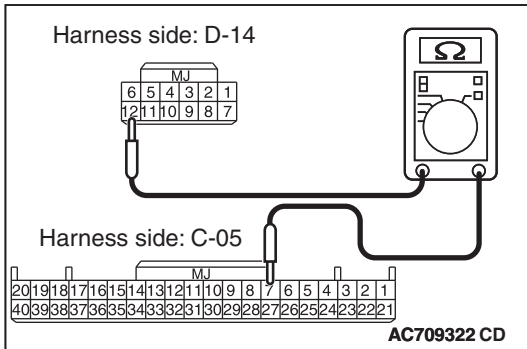

- C-05 KOS-ECU connector terminal No.9 –D-14 receiver antenna assembly connector terminal No.3.
- C-05 KOS-ECU connector terminal No.12 –D-14 receiver antenna assembly connector terminal No.1.
- C-05 KOS-ECU connector terminal No.13 –D-14 receiver antenna assembly connector terminal No.5.

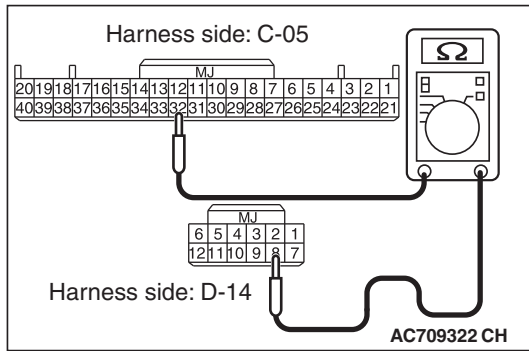

- C-05 KOS-ECU connector terminal No.32 –D-14 receiver antenna assembly connector terminal No.8.

OK: Continuity exists (2 ohms or less)

Q: Is the check result normal?

YES : Go to Step 6.

NO (C-05 KOS-ECU connector terminal No.7 –D-14 receiver antenna assembly connector terminal No.12.) :

An open circuit is present in the wiring harness between C-05 KOS-ECU connector terminal No. 7 and D-14 receiver antenna assembly connector terminal No. 12. Repair the wiring harness, and then register the ID codes. (Refer to [P.42B-227.](#)) Then go to Step 8.

NO (C-05 KOS-ECU connector terminal No.9 –D-14 receiver antenna assembly connector terminal No.3.) :

An open circuit is present in the wiring harness between C-05 KOS-ECU connector terminal No. 9 and D-14 receiver antenna assembly connector terminal No. 3. Repair the wiring harness, and then register the ID codes. (Refer to [P.42B-227.](#)) Then go to Step 8.

NO (C-05 KOS-ECU connector terminal No.12 –D-14 receiver antenna assembly connector terminal No.1.) :

An open circuit is present in the wiring harness between C-05 KOS-ECU connector terminal No. 12 and D-14 receiver antenna assembly connector terminal No. 1. Repair the wiring harness, and then register the ID codes. (Refer to [P.42B-227.](#)) Then go to Step 8.

NO (C-05 KOS-ECU connector terminal No.13 –D-14 receiver antenna assembly connector terminal No.5.) :

An open circuit is present in the wiring harness between C-05 KOS-ECU connector terminal No. 13 and D-14 receiver antenna assembly connector terminal No. 5. Repair the wiring harness, and then register the ID codes. (Refer to [P.42B-227.](#)) Then go to Step 8.

NO (C-05 KOS-ECU connector terminal No.32 –D-14 receiver antenna assembly connector terminal No.8.) :

An open circuit is present in the wiring harness between C-05 KOS-ECU connector terminal No. 32 and D-14 receiver antenna assembly connector terminal No. 8. Repair the wiring harness, and then register the ID codes. (Refer to [P.42B-227.](#)) Then go to Step 8.

STEP 6. Receiver antenna assembly check

Register the ID codes.

Q: Is the ID registration completed?

YES : Go to Step 8.

NO : Replace the receiver antenna assembly, then register the ID codes again (Refer to [P.42B-227.](#)) Then go to Step 8.

STEP 7. Check for TPMS transmitter.

Identify the TPMS transmitter which the DTC is set by TPMS transmitter check (Refer to [P.42B-236](#).)

NOTE: The TPMS transmitter which cannot be checked may be faulty or the ID code may not be registered, thus do not replace it, but register the ID code. If the transmitter is faulty, it is replaced in the ID code registration process.

Q: Are there any TPMS transmitters which are identified?

YES : Among the checked TPMS transmitters, replace the TPMS transmitters to which the DTC is set, and then register the ID codes. (Refer to [P.42B-227](#).) Then go to Step 8.

NO : Even when no transmitter is checked, register the ID codes. (Refer to [P.42B-227](#).) Then go to Step 8.

STEP 8. Diagnostic trouble code recheck after register the ID codes

- (1) Turn the ignition switch to the "ON" position.
- (2) Check if the DTC is set.
- (3) Turn the ignition switch to the "LOCK" (OFF) position.

Q: Is the DTC C1910, C1920, C1930, C1940, C1911, C1921, C1931 or C1941 set?

YES : Replace the KOS-ECU and register the ID codes (Refer to [P.42B-227](#)). Then start over at Step 1.

NO : The procedure is complete.

DTC C1913: Acceleration sensor abnormality 1

DTC C1923: Acceleration sensor abnormality 2

DTC C1933: Acceleration sensor abnormality 3

DTC C1943: Acceleration sensor abnormality 4

DTC C1914: Pressure sensor abnormality 1

DTC C1924: Pressure sensor abnormality 2

DTC C1934: Pressure sensor abnormality 3

DTC C1944: Pressure sensor abnormality 4

⚠ CAUTION

If there is any problem in the CAN bus lines, an incorrect diagnostic trouble code may be set. Prior to this diagnosis, diagnose the CAN bus lines (Refer to GROUP 54C, Trouble code diagnosis [P.54C-15](#)).

DTC SET CONDITION**DTC C1913, C1923, C1933, C1943**

- The TPMS transmitter detects if the wheel is rotated by the acceleration sensor and sends the signals to KOS-ECU. When the TPMS transmitter judges that the acceleration sensor is failed, the failure signal is send to KOS-ECU, and KOS-ECU sets this code.

DTC C1914, C1924, C1934, C1944

- The TPMS transmitter detects if the tire pressure sensor is normal and sends the signal to KOS-ECU. When the TPMS transmitter judges that the tire pressure sensor is failed, the failure signal is send to KOS-ECU, and KOS-ECU sets this code.

TROUBLESHOOTING HINTS

The most likely causes for this DTC to set are:

- Low battery that is incorporated into the TPMS transmitter
- Damaged wiring harness and connector
- Registered IDs unmatched
- Malfunction of TPMS transmitter
- Malfunction of KOS-ECU

DIAGNOSIS

Required Special Tools:

- MB991958 Scan Tool (M.U.T.-III Sub Assembly)
 - MB991824: Vehicle Communication Interface (V.C.I.)
 - MB991827 M.U.T.-III USB Cable
 - MB991910 M.U.T.-III Main Harness A

STEP 1. M.U.T.-III CAN bus diagnostics

Use scan tool to diagnose the CAN bus lines.

Q: Is the check result normal?

YES : Go to Step 3.

NO : Repair the CAN bus lines (Refer to GROUP 54C – CAN Bus Diagnostics table [P.54C-269](#)). On completion, go to Step 2.

STEP 2. Diagnostic trouble code recheck after resetting CAN bus lines

Q: Is the DTC C1913, C1923, C1933, C1943, C1914, C1924, C1934 or C1944 set?

YES : Go to Step 3.

NO : The procedure is complete.

STEP 3. Check for TPMS transmitter.

Identify the TPMS transmitter which the DTC is set by TPMS transmitter check (Refer to [P.42B-227](#)).

NOTE: The TPMS transmitter which cannot be checked may be faulty or the ID code may not be registered, thus do not replace it, but register the ID code. If the transmitter is faulty, it is replaced in the ID code registration process.

Q: Are there any TPMS transmitters which are identified?

YES : Among the checked TPMS transmitters, replace the TPMS transmitters to which the DTC is set. Then register the ID codes (Refer to [P.42B-227](#)). Then go to Step 4.

NO : Even when no transmitter is checked, register the ID codes. (Refer to [P.42B-227](#).) Then go to Step 4.

STEP 4. Diagnostic trouble code recheck after register the ID codes

- (1) Turn the ignition switch to the "LOCK" (OFF) position.
- (2) Turn the ignition switch to the "ON" position.
- (3) Check if the DTC is set.
- (4) Turn the ignition switch to the "LOCK" (OFF) position.

Q: Is the DTC C1913, C1923, C1933, C1943, C1914, C1924, C1934 or C1944 set?

YES : Replace the KOS-ECU and register the ID codes (Refer to [P.42B-227](#)). Then start over at Step 1.

NO : The procedure is complete.

DTC C1912: Tire Inflation pressure Warning 1

DTC C1922: Tire Inflation pressure Warning 2

DTC C1932: Tire Inflation pressure Warning 3

DTC C1942: Tire Inflation pressure Warning 4

 CAUTION

If there is any problem in the CAN bus lines, an incorrect diagnostic trouble code may be set. Prior to this diagnosis, diagnose the CAN bus lines (Refer to **GROUP 54C, Trouble code diagnosis P.54C-15**).

DTC SET CONDITION

When the tire pressure included in the signal from the TPMS transmitter is less than the specified value, KOS-ECU sets this code.

TROUBLESHOOTING HINTS

The most likely causes for this DTC to set is:

- Drop of tire pressure
- Loose TPMS transmitter mounting nut
- Flat tire
- TPMS transmitter malfunction
- KOS-ECU malfunction
- CAN-bus line malfunction

DIAGNOSIS**Required Special Tools:**

- MB991958 Scan Tool (M.U.T.-III Sub Assembly)
 - MB991824: Vehicle Communication Interface (V.C.I.)
 - MB991827 M.U.T.-III USB Cable
 - MB991910 M.U.T.-III Main Harness A

STEP 1. Using scan tool MB991958, diagnose the CAN bus lines.

Use scan tool to diagnose the CAN bus lines.

Q: Is the check result normal?

YES : Go to Step 3.

NO : Repair the CAN bus lines (Refer to GROUP 54C – CAN Bus Diagnostics table [P.54C-269](#)). On completion, go to Step 2.

STEP 2. Diagnostic trouble code recheck after resetting CAN bus lines

Q: Is DTC C1912, C1922, C1932 or C1942 set?

YES : Go to Step 3.

NO : The procedure is complete.

STEP 3. Tire check

Check that there is no abnormality for the items below.

- Flat tire
- Cracked tire
- Air leak from valve
- Loose TPMS transmitter mounting nut (Refer to [P.42B-247](#)).

Q: Is the check result normal?

YES : Go to Step 4.

NO : Replace it. Then go to Step 4.

STEP 4. Diagnostic trouble code check

(1) Turn the ignition switch to the "ON" position, and adjust the pressure to the recommended tire pressure.

(2) Check if the DTC is set.

Q: Is DTC C1912, C1922, C1932 or C1942 set?

YES : Go to Step 5.

NO : The procedure is complete.

STEP 5. Diagnostic trouble code check

(1) Drive the vehicle for five minutes.

NOTE: Even within 5 minutes, if the TPMS warning light goes out, finish the driving and perform the operation (2).

(2) Check if the DTC is set.

Q: Is DTC C1912, C1922, C1932 or C1942 set?

YES : Go to Step 6.

NO : The procedure is complete.

STEP 6. Tire pressure check by scan tool

- (1) Perform the transmitter check using the scan tool (Refer to [P.42B-227](#)), and check the tire pressure values of all the wheels.
- (2) Check the tire pressure of all the wheels using the tire pressure gauge.
- (3) Compare the measured value (1) with (2).

OK: 20 kPa (2.9 psi) or less

NOTE: Do not replace the TPMS transmitter which cannot be checked.

Q: Is the check result normal?

YES : Replace the KOS-ECU and register the ID codes (Refer to [P.42B-227](#)). Then go to Step 9.

NO : Go to Step 7.

STEP 7. Tire pressure check by scan tool

- (1) Perform the transmitter check using the scan tool (Refer to [P.42B-227](#)), and check the tire pressure values of all the wheels.
- (2) Check the tire pressure of all the wheels using the tire pressure gauge.
- (3) Compare the measured value (1) with (2).

OK: 20 kPa (2.9 psi) or less

Q: Is the check result normal?

YES : Replace the KOS-ECU and register the ID codes (Refer to [P.42B-227](#)). Then go to Step 9.

NO : Replace the TPMS transmitter and register the ID codes (Refer to [P.42B-11](#)). Then go to Step 8.

STEP 8. Recheck for diagnostic trouble code.

- (1) Turn the ignition switch to the "LOCK" (OFF) position.
- (2) Turn the ignition switch to the "ON" position.
- (3) Check if the DTC is set.
- (4) Turn the ignition switch to the "LOCK" (OFF) position.

Q: Is the DTC C1912, C1922, C1932 or C1942 set?

YES : Replace the KOS-ECU and register the ID codes (Refer to [P.42B-227](#)). Then go to Step 9.

NO : The procedure is complete.

STEP 9. Recheck for diagnostic trouble code.

- (1) Turn the ignition switch to the "LOCK" (OFF) position.
- (2) Turn the ignition switch to the "ON" position.
- (3) Check if the DTC is set.
- (4) Turn the ignition switch to the "LOCK" (OFF) position.

Q: Is the DTC C1912, C1922, C1932 or C1942 set?

YES : Start over at Step 1.

NO : The procedure is complete.

DTC C1915: Transmitter OFF Mode 1
DTC C1925: Transmitter OFF Mode 2
DTC C1935: Transmitter OFF Mode 3
DTC C1945: Transmitter OFF Mode 4

⚠ CAUTION

If there is any problem in the CAN bus lines, an incorrect diagnostic trouble code may be set. Prior to this diagnosis, diagnose the CAN bus lines (Refer to GROUP 54C, Trouble code diagnosis [P.54C-15](#)).

DTC SET CONDITION

When the TPMS transmitter(s) is in the OFF MODE, this code is set.

TROUBLESHOOTING HINTS

The most likely causes for this DTC to set are:

- OFF mode cancellation not performed
- Damaged wiring harness and connector
- Malfunction of TPMS transmitter
- Malfunction of KOS-ECU

DIAGNOSIS

Required Special Tools:

- MB991958: Scan Tool (M.U.T.-III Sub Assembly)
 - MB991824: Vehicle Communication Interface (V.C.I.)
 - MB991827: M.U.T.-III USB Cable
 - MB991910: M.U.T.-III Main Harness A

STEP 1. Using scan tool MB991958, diagnose the CAN bus lines.

Use scan tool to diagnose the CAN bus lines.

Q: Is the check result normal?

YES : Go to Step 3.

NO : Repair the CAN bus lines (Refer to GROUP 54C – CAN Bus Diagnostics table [P.54C-269](#)). On completion, go to Step 2.

STEP 2. Diagnostic trouble code recheck after resetting CAN bus lines

- (1) Turn the ignition switch to the "LOCK" (OFF) position.
- (2) Turn the ignition switch to the "ON" position.
- (3) Check if the DTC is set.
- (4) Turn the ignition switch to the "LOCK" (OFF) position.

Q: Is DTC C1915, C1925, C1935 or C1945 set?

YES : Go to Step 3.

NO : The procedure is complete.

STEP 3. Diagnostic trouble code check

- (1) Drive the vehicle for five minutes.
- (2) Turn the ignition switch to the "LOCK" (OFF) position.
- (3) Turn the ignition switch to the "ON" position.
- (4) Check if the DTC is set.
- (5) Turn the ignition switch to the "LOCK" (OFF) position.

Q: Are the all DTC C1915, C1925, C1935 and C1945 set?

YES : Replace the TPMS transmitters of all the four wheels, and register ID codes (Refer to [P.42B-241](#)). Then go to Step 4.

NO : Register the ID codes (Refer to [P.42B-241](#)). Then go to Step 4.

STEP 4. Diagnostic trouble code recheck after register the ID codes

- (1) Turn the ignition switch to the "ON" position.
- (2) Check if the DTC is set.
- (3) Turn the ignition switch to the "LOCK" (OFF) position.

Q: Is DTC C1915, C1925, C1935 or C1945 set?

YES : Replace the KOS-ECU and register the ID codes (Refer to [P.42B-241](#)). Then start over at Step 1.

NO : The procedure is complete.

DTC U0019: Bus off (CAN-B)**CAUTION**

- If DTC U0019 is set, be sure to diagnose the CAN bus line.
- When replacing the ECU, always check that the communication circuit is normal.

DIAGNOSTIC FUNCTION

If the CAN-B circuit malfunction occurs, the combination meter sets DTC U0019.

JUDGMENT CRITERIA

If KOS-ECU cannot perform the data transmission in normal conditions due to a malfunction of the CAN-B bus circuit, KOS-ECU determines that there is a problem.

TROUBLESHOOTING HINTS

The CAN bus line may be defective

DIAGNOSIS**Required Special Tools:**

- MB991958: Scan Tool (M.U.T.-III Sub Assembly)
 - MB991824: Vehicles Communication Interface (V.C.I.)
 - MB991827: M.U.T.-III USB Cable
 - MB991910: M.U.T.-III Main Harness A

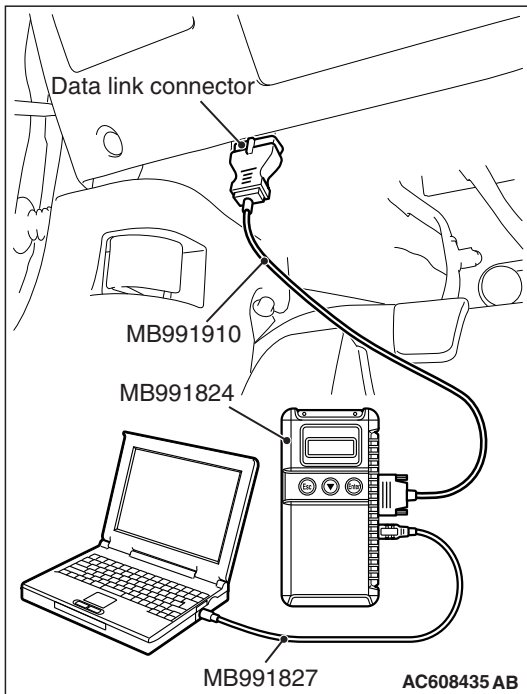

STEP 1. Using scan tool MB991958, diagnose the CAN bus line.

⚠ CAUTION

To prevent damage to scan tool MB991958, always turn the ignition switch to the "LOCK" (OFF) position before connecting or disconnecting scan tool MB991958.

- (1) Connect scan tool MB991958. Refer to "How to connect the Scan Tool (M.U.T.-III) P.42B-9."
- (2) Turn the ignition switch to the "ON" position.
- (3) Diagnose the CAN bus line.
- (4) Turn the ignition switch to the "LOCK" (OFF) position.

Q: Is the CAN bus line found to be normal?

YES : Go to Step 2.

NO : Repair the CAN bus line (Refer to GROUP 54C, Diagnosis P.54C-15).

STEP 2.Recheck for diagnostic trouble code.

Check again if the DTC is set to the KOS-ECU.

- (1) Erase the DTC.
- (2) Turn the ignition switch from "LOCK" (OFF) position to "ON" position.
- (3) Check if DTC is set.
- (4) Turn the ignition switch to the "LOCK" (OFF) position.

Q: Is the DTC set?

YES : Replace KOS-ECU and register the ID codes (Refer to P.42B-11).

NO : The trouble can be an intermittent malfunction (Refer to GROUP 00 –How to use Troubleshooting/inspection Service Points –How to Cope with Intermittent Malfunction P.00-15).

DTC U0141: ETACS-ECU CAN timeout**CAUTION**

- If DTC U0141 is set, be sure to diagnose the CAN bus line.
- When replacing the ECU, always check that the communication circuit is normal.

DIAGNOSTIC FUNCTION

If the signal from ETACS-ECU cannot be received, the KOS-ECU sets DTC U0141.

TROUBLESHOOTING HINTS

- Malfunction of CAN bus line
- Malfunction of KOS-ECU
- Malfunction of ETACS-ECU

DIAGNOSIS**Required Special Tools:**

- MB991958: Scan Tool (M.U.T.-III Sub Assembly)
 - MB991824: Vehicles Communication Interface (V.C.I.)
 - MB991827: M.U.T.-III USB Cable
 - MB991910: M.U.T.-III Main Harness A

STEP 1. Using scan tool MB991958, diagnose the CAN bus line**CAUTION**

To prevent damage to scan tool MB991958, always turn the ignition switch to the "LOCK" (OFF) position before connecting or disconnecting scan tool MB991958.

- (1) Connect scan tool MB991958. Refer to "How to connect the Scan Tool (M.U.T.-III) P.42B-9."
- (2) Turn the ignition switch to the "ON" position.
- (3) Diagnose the CAN bus line.
- (4) Turn the ignition switch to the "LOCK" (OFF) position.

Q: Is the CAN bus line found to be normal?

YES : Go to Step 2.

NO : Repair the CAN bus line (Refer to GROUP 54C, Diagnosis P.54C-15).

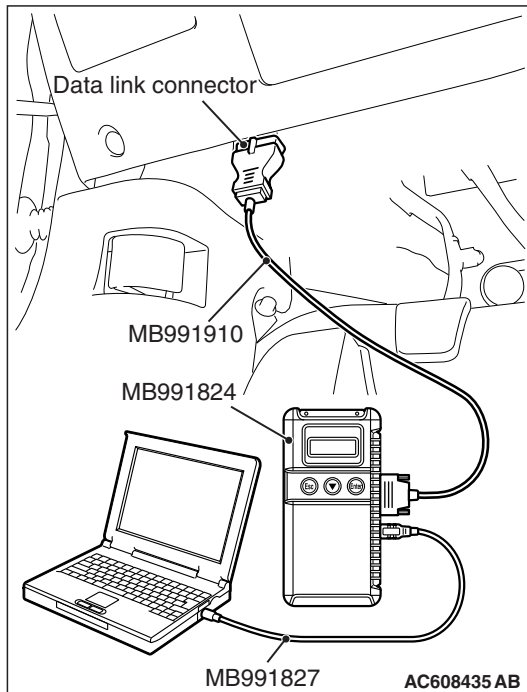
**STEP 2. Using scan tool MB991958, read the ETACS-ECU diagnostic trouble code**

Check again if the DTC is set to the ETACS-ECU.

Q: Is the DTC set?

YES : Diagnose the ETACS-ECU (Refer to GROUP 54A – Diagnosis P.54A-646).

NO : Go to Step 3.

STEP 3. Using scan tool MB991958, read the other system diagnostic trouble code.

Check if DTC U0141 is set to the combination meter.

Q: Is the DTC set?

YES : Go to Step 4.

NO : Go to Step 5.

STEP 4. Recheck for diagnostic trouble code.

Check again if the DTC is set to the KOS-ECU.

(1) Erase the DTC.

(2) Turn the ignition switch from "LOCK" (OFF) position to "ON" position.

(3) Check if DTC is set.

(4) Turn the ignition switch to the "LOCK" (OFF) position.

Q: Is the DTC set?

YES : Replace the ETACS-ECU.

NO : The trouble can be an intermittent malfunction (Refer to GROUP 00 –How to use Troubleshooting/inspection Service Points –How to Cope with Intermittent Malfunction [P.00-15](#)).

STEP 5. Recheck for diagnostic trouble code.

Check again if the DTC is set to the KOS-ECU.

(1) Erase the DTC.

(2) Turn the ignition switch from "LOCK" (OFF) position to "ON" position.

(3) Check if DTC is set.

(4) Turn the ignition switch to the "LOCK" (OFF) position.

Q: Is the DTC set?

YES : Replace KOS-ECU and register the ID codes. (Refer to [P.42B-11](#).)

NO : The trouble can be an intermittent malfunction (Refer to GROUP 00 –How to use Troubleshooting/inspection Service Points –How to Cope with Intermittent Malfunction [P.00-15](#)).

DTC U0151: SRS-ECU CAN timeout**CAUTION**

- If DTC U0151 is set, be sure to diagnose the CAN bus line.
- When replacing the ECU, always check that the communication circuit is normal.

DIAGNOSTIC FUNCTION

If no signal from SRS-ECU can be received, KOS-ECU sets diagnostic trouble code No. U0151.

TROUBLESHOOTING HINTS

- The CAN bus line may be defective
- The SRS-ECU may be defective
- Malfunction of KOS-ECU

DIAGNOSIS**Required Special Tools:**

- MB991958: Scan Tool (M.U.T.-III Sub Assembly)
 - MB991824: Vehicles Communication Interface (V.C.I.)
 - MB991827: M.U.T.-III USB Cable
 - MB991910: M.U.T.-III Main Harness A

STEP 1. Using scan tool MB991958, diagnose the CAN bus line**CAUTION**

To prevent damage to scan tool MB991958, always turn the ignition switch to the "LOCK" (OFF) position before connecting or disconnecting scan tool MB991958.

- (1) Connect scan tool MB991958. Refer to "How to connect the Scan Tool (M.U.T.-III) P.42B-9."
- (2) Turn the ignition switch to the "ON" position.
- (3) Diagnose the CAN bus line.
- (4) Turn the ignition switch to the "LOCK" (OFF) position.

Q: Is the CAN bus line found to be normal?

YES : Go to Step 2.

NO : Repair the CAN bus line (Refer to GROUP 54C, Diagnosis P.54C-15).

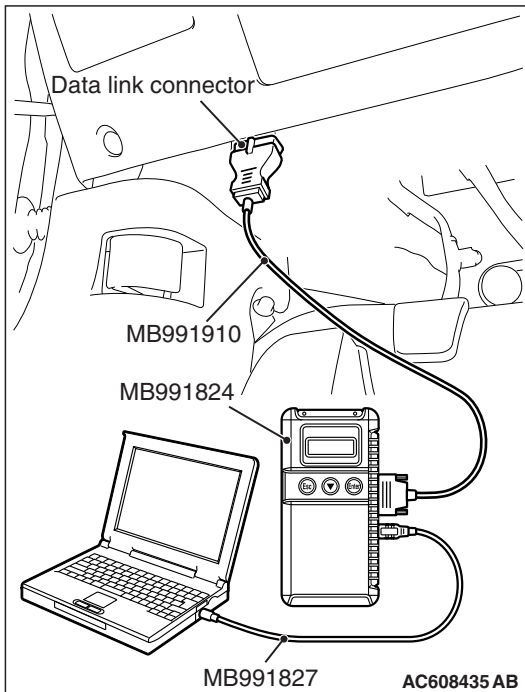
**STEP 2. Using scan tool MB991958, read the SRS-ECU diagnostic trouble code**

Check again if the DTC is set to the SRS-ECU.

Q: Is the DTC set?

YES : Troubleshoot the SRS (Refer to GROUP 52B, Troubleshooting P.52B-30).

NO : Go to Step 3.

STEP 3. Using scan tool MB991958, read the other system diagnostic trouble code.

Check if DTC U0151 is set to the combination meter.

Q: Is the DTC set?

YES : Go to Step 4.

NO : Go to Step 5.

STEP 4. Recheck for diagnostic trouble code.

Check again if the DTC is set to the KOS-ECU.

(1) Erase the DTC.

(2) Turn the ignition switch from "LOCK" (OFF) position to "ON" position.

(3) Check if DTC is set.

(4) Turn the ignition switch to the "LOCK" (OFF) position.

Q: Is the DTC set?

YES : Replace the SRS-ECU.

NO : The trouble can be an intermittent malfunction (Refer to GROUP 00 –How to use Troubleshooting/inspection Service Points –How to Cope with Intermittent Malfunction [P.00-15](#)).

STEP 5. Recheck for diagnostic trouble code.

Check again if the DTC is set to the KOS-ECU.

(1) Erase the DTC.

(2) Turn the ignition switch from "LOCK" (OFF) position to "ON" position.

(3) Check if DTC is set.

(4) Turn the ignition switch to the "LOCK" (OFF) position.

Q: Is the DTC set?

YES : Replace KOS-ECU and register the ID codes. (Refer to [P.42B-11](#).)

NO : The trouble can be an intermittent malfunction (Refer to GROUP 00 –How to use Troubleshooting/inspection Service Points –How to Cope with Intermittent Malfunction [P.00-15](#)).

DTC U0154: Occupant classification-ECU CAN timeout**CAUTION**

- If DTC U0154 is set, be sure to diagnose the CAN bus line.
- When replacing the ECU, always check that the communication circuit is normal.

DIAGNOSTIC FUNCTION

When the signals from occupant classification-ECU cannot be received, the KOS-ECU sets DTC U0154.

TROUBLESHOOTING HINTS

- The CAN bus line may be defective.
- The KOS-ECU may be defective.
- The occupant classification-ECU may be defective.

DIAGNOSIS**Required Special Tools:**

- MB991958: Scan Tool (M.U.T.-III Sub Assembly)
 - MB991824: Vehicles Communication Interface (V.C.I.)
 - MB991827: M.U.T.-III USB Cable
 - MB991910: M.U.T.-III Main Harness A

STEP 1. Using scan tool MB991958, diagnose the CAN bus line**CAUTION**

To prevent damage to scan tool MB991958, always turn the ignition switch to the "LOCK" (OFF) position before connecting or disconnecting scan tool MB991958.

- (1) Connect scan tool MB991958. Refer to "How to connect the Scan Tool (M.U.T.-III) P.42B-9."
- (2) Turn the ignition switch to the "ON" position.
- (3) Diagnose the CAN bus line.
- (4) Turn the ignition switch to the "LOCK" (OFF) position.

Q: Is the CAN bus line found to be normal?

YES : Go to Step 2.

NO : Repair the CAN bus line (Refer to GROUP 54C, Diagnosis P.54C-15).

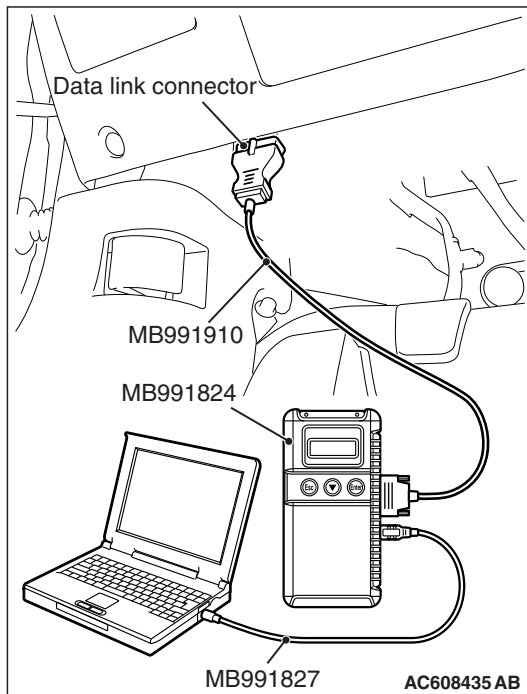
**STEP 2. Using scan tool MB991958, read the occupant classification-ECU diagnostic trouble code.**

Check if DTC is set to the occupant classification-ECU.

Q: Is the DTC set?

YES : Troubleshoot the SRS. (Refer to GROUP 52B, Diagnosis P.52B-316.)

NO : Go to Step 3.

STEP 3. Using scan tool MB991958, read the other system diagnostic trouble code.

Check if DTC U0154 is set to the combination meter.

Q: Is the DTC set?

YES : Go to Step 4.

NO : Go to Step 5.

STEP 4. Recheck for diagnostic trouble code.

Check again if the DTC is set to the KOS-ECU.

(1) Erase the DTC.

(2) Turn the ignition switch from "LOCK" (OFF) position to "ON" position.

(3) Check if DTC is set.

(4) Turn the ignition switch to the "LOCK" (OFF) position.

Q: Is the DTC set?

YES : Replace the occupant classification-ECU.

NO : The trouble can be an intermittent malfunction (Refer to GROUP 00 –How to use Troubleshooting/inspection Service Points –How to Cope with Intermittent Malfunction [P.00-15](#)).

STEP 5. Recheck for diagnostic trouble code.

Check again if the DTC is set to the KOS-ECU.

(1) Erase the DTC.

(2) Turn the ignition switch from "LOCK" (OFF) position to "ON" position.

(3) Check if DTC is set.

(4) Turn the ignition switch to the "LOCK" (OFF) position.

Q: Is the DTC set?

YES : Replace KOS-ECU and register the ID codes. (Refer to [P.42B-11](#).)

NO : The trouble can be an intermittent malfunction (Refer to GROUP 00 –How to use Troubleshooting/inspection Service Points –How to Cope with Intermittent Malfunction [P.00-15](#)).

DTC U0155: Combination meter CAN timeout**CAUTION**

- If DTC U0155 is set, be sure to diagnose the CAN bus line.
- When replacing the ECU, always check that the communication circuit is normal.

TROUBLE JUDGMENT

If no signal from the combination meter can be received, KOS-ECU sets DTC U0155.

TROUBLESHOOTING HINTS

- Malfunction of CAN bus line
- Combination meter malfunction
- Malfunction of KOS-ECU

DIAGNOSIS**Required Special Tools:**

- MB991958: Scan Tool (M.U.T.-III Sub Assembly)
 - MB991824: Vehicles Communication Interface (V.C.I.)
 - MB991827: M.U.T.-III USB Cable
 - MB991910: M.U.T.-III Main Harness A

STEP 1. Using scan tool MB991958, diagnose the CAN bus line.**CAUTION**

To prevent damage to scan tool MB991958, always turn the ignition switch to the "LOCK" (OFF) position before connecting or disconnecting scan tool MB991958.

- (1) Connect scan tool MB991958. Refer to "How to connect the Scan Tool (M.U.T.-III) P.42B-9."
- (2) Turn the ignition switch to the "ON" position.
- (3) Diagnose the CAN bus line.
- (4) Turn the ignition switch to the "LOCK" (OFF) position.

Q: Is the CAN bus line found to be normal?

YES : Go to Step 2.

NO : Repair the CAN bus line (Refer to GROUP 54C, Diagnosis P.54C-15).

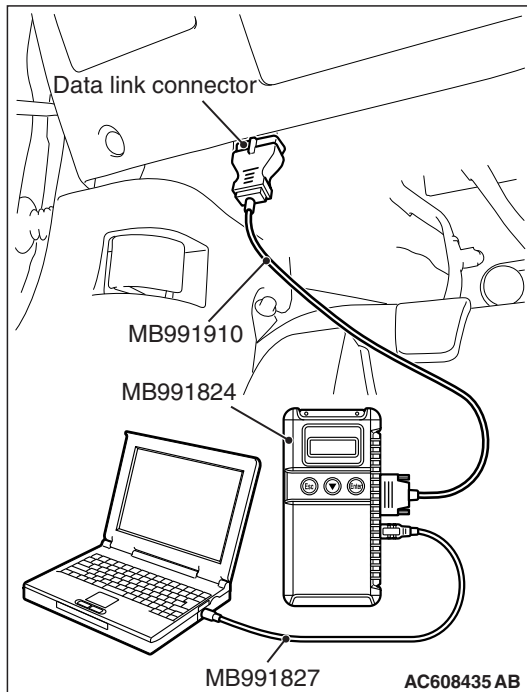
**STEP 2. Using scan tool MB991958, read the combination meter diagnostic trouble code**

Check if DTC is set to the combination meter.

Q: Is the DTC set?

YES : Troubleshoot the combination meter. (Refer to GROUP 54A, Diagnosis P.54A-32.)

NO : Go to Step 3.

STEP 3. Using scan tool MB991958, read the A/C-ECU diagnostic trouble code.

Check if the DTC U0155 is set to the A/C-ECU.

Q: Is the DTC set?

YES : Go to Step 4.

NO : Go to Step 5.

STEP 4. Recheck for diagnostic trouble code.

Check again if the DTC is set to the KOS-ECU.

(1) Erase the DTC.

(2) Turn the ignition switch from "LOCK" (OFF) position to "ON" position.

(3) Check if DTC is set.

(4) Turn the ignition switch to the "LOCK" (OFF) position.

Q: Is the DTC set?

YES : Replace the combination meter.

NO : The trouble can be an intermittent malfunction such as a poor connection or open circuit in the CAN bus lines between the combination meter and the ETACS-ECU. (Refer to GROUP 00, How to Cope with Intermittent Malfunction [P.00-15](#))

STEP 5. Recheck for diagnostic trouble code.

Check again if the DTC is set to the KOS-ECU.

(1) Erase the DTC.

(2) Turn the ignition switch from "LOCK" (OFF) position to "ON" position.

(3) Check if DTC is set.

(4) Turn the ignition switch to the "LOCK" (OFF) position.

Q: Is the DTC set?

YES : Replace KOS-ECU and register the ID codes. (Refer to [P.42B-11.](#))

NO : The trouble can be an intermittent malfunction such as a poor connection or open circuit in the CAN bus lines between the combination meter and the ETACS-ECU. (Refer to GROUP 00, How to Cope with Intermittent Malfunction [P.00-15](#))

DTC U0164: A/C-ECU CAN timeout**CAUTION**

- If DTC U0164 is set, be sure to diagnose the CAN bus line.
- When replacing the ECU, always check that the communication circuit is normal.

DIAGNOSTIC FUNCTION

If the signal from A/C-ECU cannot be received, the KOS-ECU sets DTC U0164.

TROUBLESHOOTING HINTS

- The CAN bus line may be defective.
- The A/C-ECU may be defective.
- The KOS-ECU may be defective.

DIAGNOSIS**Required Special Tools:**

- MB991958: Scan Tool (M.U.T.-III Sub Assembly)
 - MB991824: Vehicles Communication Interface (V.C.I.)
 - MB991827: M.U.T.-III USB Cable
 - MB991910: M.U.T.-III Main Harness A

STEP 1. Using scan tool MB991958, diagnose the CAN bus line**CAUTION**

To prevent damage to scan tool MB991958, always turn the ignition switch to the "LOCK" (OFF) position before connecting or disconnecting scan tool MB991958.

- (1) Connect scan tool MB991958. Refer to "How to connect the Scan Tool (M.U.T.-III) P.42B-9."
- (2) Turn the ignition switch to the "ON" position.
- (3) Diagnose the CAN bus line.
- (4) Turn the ignition switch to the "LOCK" (OFF) position.

Q: Is the CAN bus line found to be normal?

YES : Go to Step 2.

NO : Repair the CAN bus line (Refer to GROUP 54C, Diagnosis P.54C-15). Then go to Step 3.

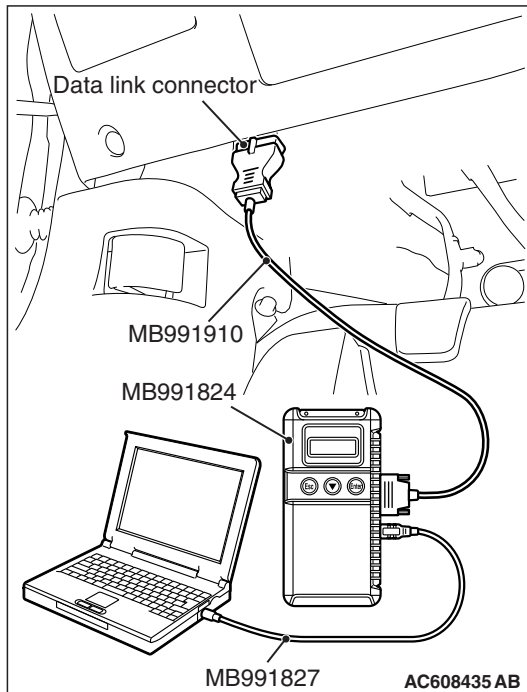
**STEP 2. Using scan tool MB991958, read the A/C diagnostic trouble code**

Check if DTC is set to the A/C-ECU.

Q: Is the DTC set?

YES : Troubleshoot the A/C (Refer to GROUP 55, Diagnosis P.55-10).

NO : Go to Step 3.

STEP 3. Using scan tool MB991958, read the other system diagnostic trouble code.

Check if DTC U0164 is set to the combination meter.

Q: Is the DTC set?

YES : Go to Step 4.

NO : Go to Step 5.

STEP 4. Recheck for diagnostic trouble code.

Check again if the DTC is set to the KOS-ECU.

(1) Erase the DTC.

(2) Turn the ignition switch from "LOCK" (OFF) position to "ON" position.

(3) Check if DTC is set.

(4) Turn the ignition switch to the "LOCK" (OFF) position.

Q: Is the DTC set?

YES : Replace the A/C-ECU.

NO : The trouble can be an intermittent malfunction (Refer to GROUP 00 –How to use Troubleshooting/inspection Service Points –How to Cope with Intermittent Malfunction [P.00-15](#)).

STEP 5. Recheck for diagnostic trouble code.

Check again if the DTC is set to the KOS-ECU.

(1) Erase the DTC.

(2) Turn the ignition switch from "LOCK" (OFF) position to "ON" position.

(3) Check if DTC is set.

(4) Turn the ignition switch to the "LOCK" (OFF) position.

Q: Is the DTC set?

YES : Replace KOS-ECU and register the ID codes. (Refer to [P.42B-11](#).)

NO : The trouble can be an intermittent malfunction (Refer to GROUP 00 –How to use Troubleshooting/inspection Service Points –How to Cope with Intermittent Malfunction [P.00-15](#)).

DTC U0184: Audio CAN timeout**⚠ CAUTION**

- If DTC U0184 is set, be sure to diagnose the CAN bus line.
- When replacing the ECU, always check that the communication circuit is normal.

DIAGNOSTIC FUNCTION

When the signals from radio and CD player or CD changer cannot be received, the KOS-ECU sets DTC U0184.

TROUBLESHOOTING HINTS

- The CAN bus line may be defective.
- The KOS-ECU may be defective.
- The radio and CD player or CD changer may be defective.

DIAGNOSIS**Required Special Tools:**

- MB991958: Scan Tool (M.U.T.-III Sub Assembly)
 - MB991824: Vehicles Communication Interface (V.C.I.)
 - MB991827: M.U.T.-III USB Cable
 - MB991910: M.U.T.-III Main Harness A

STEP 1. Using scan tool MB991958, diagnose the CAN bus line**⚠ CAUTION**

To prevent damage to scan tool MB991958, always turn the ignition switch to the "LOCK" (OFF) position before connecting or disconnecting scan tool MB991958.

- (1) Connect scan tool MB991958. Refer to "How to connect the Scan Tool (M.U.T.-III) P.42B-9."
- (2) Turn the ignition switch to the "ON" position.
- (3) Diagnose the CAN bus line.
- (4) Turn the ignition switch to the "LOCK" (OFF) position.

Q: Is the CAN bus line found to be normal?

YES : Go to Step 2.

NO : Repair the CAN bus line (Refer to GROUP 54C, Diagnosis P.54C-15).

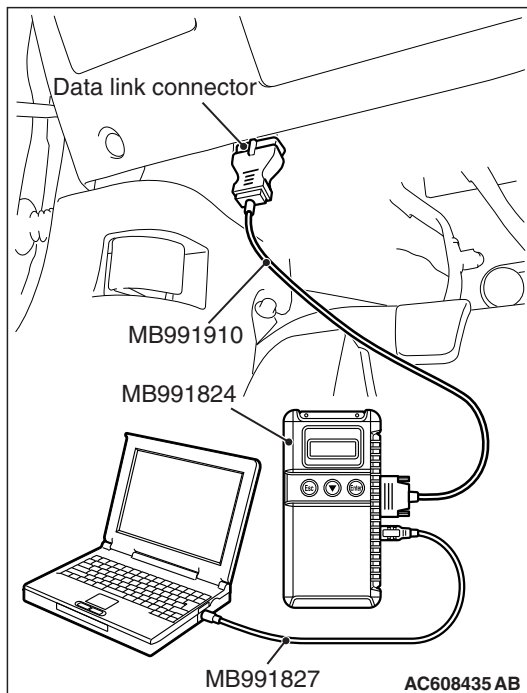

STEP 2. Using scan tool MB991958, read the audio diagnostic trouble code

Check again if the DTC is set to the audio.

Q: Is the DTC set?

YES : Troubleshoot the radio and CD player. Refer to GROUP 54A, Diagnosis <radio and CD player> [P.54A-322](#).

NO : Go to Step 3.

STEP 3. Using scan tool MB991958, read the other system diagnostic trouble code.

Check if DTC U0184 is set to the combination meter.

Q: Is the DTC set?

YES : Go to Step 4.

NO : Go to Step 5.

STEP 4. Recheck for diagnostic trouble code.

Check again if the DTC is set to the KOS-ECU.

(1) Erase the DTC.

(2) Turn the ignition switch from "LOCK" (OFF) position to "ON" position.

(3) Check if DTC is set.

(4) Turn the ignition switch to the "LOCK" (OFF) position.

Q: Is the DTC set?

YES : Replace the radio and CD player or CD changer.

NO : The trouble can be an intermittent malfunction (Refer to GROUP 00 –How to use Troubleshooting/inspection Service Points –How to Cope with Intermittent Malfunction [P.00-15](#)).

STEP 5. Recheck for diagnostic trouble code.

Check again if the DTC is set to the KOS-ECU.

(1) Erase the DTC.

(2) Turn the ignition switch from "LOCK" (OFF) position to "ON" position.

(3) Check if DTC is set.

(4) Turn the ignition switch to the "LOCK" (OFF) position.

Q: Is the DTC set?

YES : Replace KOS-ECU and register the ID codes. (Refer to [P.42B-11](#).)

NO : The trouble can be an intermittent malfunction (Refer to GROUP 00 –How to use Troubleshooting/inspection Service Points –How to Cope with Intermittent Malfunction [P.00-15](#)).

DTC U0195: Satellite radio tuner CAN timeout**CAUTION**

- If DTC U0195 is set to the ETACS-ECU, always diagnose the CAN bus line.
- Before replacing the ECU, ensure that the communication circuit is normal.

TROUBLE JUDGMENT

If the signal from satellite radio tuner cannot be received, the KOS-ECU sets DTC U0195.

TROUBLESHOOTING HINTS

- The satellite radio tuner may be defective.
- The KOS-ECU may be defective.
- The CAN bus may be defective.

DIAGNOSIS**Required Special Tools:**

- MB991958: Scan Tool (M.U.T.-III Sub Assembly)
 - MB991824: Vehicle Communication Interface (V.C.I.)
 - MB991827: M.U.T.-III USB Cable
 - MB991910: M.U.T.-III Main Harness A

STEP 1. Using scan tool MB991958, diagnose the CAN bus line.**CAUTION**

To prevent damage to scan tool MB991958, always turn the ignition switch to the "LOCK" (OFF) position before connecting or disconnecting scan tool MB991958.

- (1) Connect scan tool MB991958. Refer to "How to connect the Scan Tool (M.U.T.-III) P.42C-6."
- (2) Turn the ignition switch to the "ON" position.
- (3) Diagnose the CAN bus line.
- (4) Turn the ignition switch to the "LOCK" (OFF) position.

Q: Is the CAN bus line found to be normal?

YES : Go to Step 2.

NO : Repair the CAN bus line (Refer to GROUP 54C, Diagnosis P.54C-15).

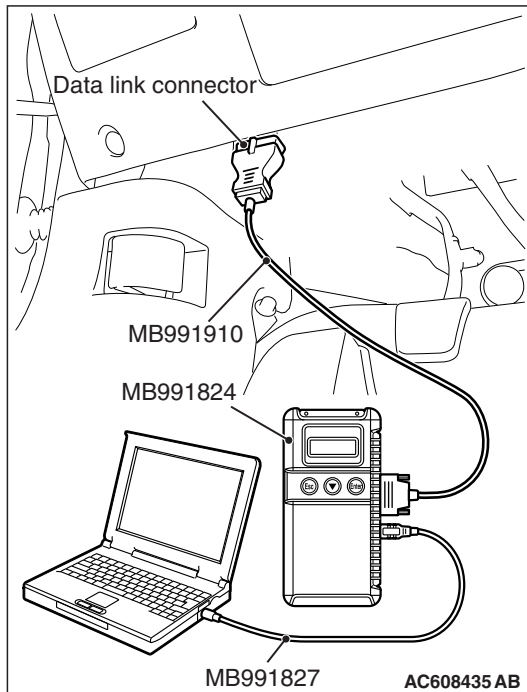
**STEP 2. Using scan tool MB991958, read the satellite radio tuner diagnostic trouble code.**

Check if DTC is set to the satellite radio tuner.

Q: Is the DTC set?

YES : Troubleshoot the satellite radio. (Refer to GROUP 54B, Diagnosis <Satellite radio tuner>.)

NO : Go to Step 3.

STEP 3. Using scan tool MB991958, read the other system diagnostic trouble code.

Check if DTC U0195 is set to the combination meter.

Q: Is the DTC set?

YES : Go to Step 4.

NO : Go to Step 5.

STEP 4. Recheck for diagnostic trouble code.

Check again if the DTC is set to the KOS-ECU.

(1) Erase the DTC.

(2) Turn the ignition switch from "LOCK" (OFF) position to "ON" position.

(3) Check if DTC is set.

(4) Turn the ignition switch to the "LOCK" (OFF) position.

Q: Is the DTC set?

YES : Replace the satellite radio tuner.

NO : The trouble can be an intermittent malfunction (Refer to GROUP 00 –How to use Troubleshooting/inspection Service Points –How to Cope with Intermittent Malfunction [P.00-15](#)).

STEP 5. Recheck for diagnostic trouble code.

Check again if the DTC is set to the KOS-ECU.

(1) Erase the DTC.

(2) Turn the ignition switch from "LOCK" (OFF) position to "ON" position.

(3) Check if DTC is set.

(4) Turn the ignition switch to the "LOCK" (OFF) position.

Q: Is the DTC set?

YES : Replace KOS-ECU and register the ID codes. (Refer to [P.42B-11](#).)

NO : The trouble can be an intermittent malfunction (Refer to GROUP 00 –How to use Troubleshooting/inspection Service Points –How to Cope with Intermittent Malfunction [P.00-15](#)).

DTC U0197: Hands free module CAN timeout**CAUTION**

- If DTC U0197 is set, be sure to diagnose the CAN bus line.
- When replacing the ECU, always check that the communication circuit is normal.

DIAGNOSTIC FUNCTION

When the signals from hands free module cannot be received, the KOS-ECU sets DTC U0197.

TROUBLESHOOTING HINTS

- The CAN bus line may be defective.
- The KOS-ECU may be defective.
- The hands free module may be defective.

DIAGNOSIS**Required Special Tools:**

- MB991958: Scan Tool (M.U.T.-III Sub Assembly)
 - MB991824: Vehicles Communication Interface (V.C.I.)
 - MB991827: M.U.T.-III USB Cable
 - MB991910: M.U.T.-III Main Harness A

STEP 1. Using scan tool MB991958, diagnose the CAN bus line**CAUTION**

To prevent damage to scan tool MB991958, always turn the ignition switch to the "LOCK" (OFF) position before connecting or disconnecting scan tool MB991958.

- (1) Connect scan tool MB991958. Refer to "How to connect the Scan Tool (M.U.T.-III) P.42B-9."
- (2) Turn the ignition switch to the "ON" position.
- (3) Diagnose the CAN bus line.
- (4) Turn the ignition switch to the "LOCK" (OFF) position.

Q: Is the CAN bus line found to be normal?

YES : Go to Step 2.

NO : Repair the CAN bus line (Refer to GROUP 54C, Diagnosis P.54C-15).

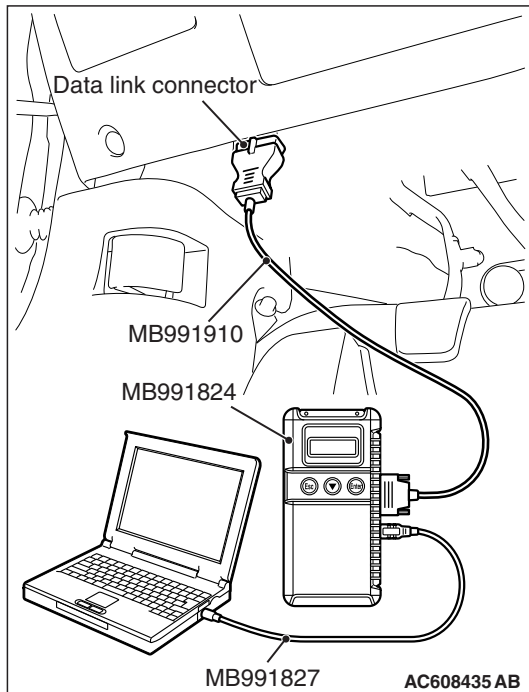
**STEP 2. Using scan tool MB991958, read the hands free module diagnostic trouble code**

Check again if the DTC is set to the hands free module.

Q: Is the DTC set?

YES : Troubleshoot the hands-free cellular phone system. Refer to GROUP 54A, Diagnosis <hands-free cellular phone system>.

NO : Go to Step 3.

STEP 3. Using scan tool MB991958, read the other system diagnostic trouble code.

Check if DTC U0197 is set to the combination meter.

Q: Is the DTC set?

YES : Go to Step 4.

NO : Go to Step 5.

STEP 4. Recheck for diagnostic trouble code.

Check again if the DTC is set to the KOS-ECU.

(1) Erase the DTC.

(2) Turn the ignition switch from "LOCK" (OFF) position to "ON" position.

(3) Check if DTC is set.

(4) Turn the ignition switch to the "LOCK" (OFF) position.

Q: Is the DTC set?

YES : Replace The hands free module.

NO : The trouble can be an intermittent malfunction (Refer to GROUP 00 –How to use Troubleshooting/inspection Service Points –How to Cope with Intermittent Malfunction [P.00-15](#)).

STEP 5. Recheck for diagnostic trouble code.

Check again if the DTC is set to the KOS-ECU.

(1) Erase the DTC.

(2) Turn the ignition switch from "LOCK" (OFF) position to "ON" position.

(3) Check if DTC is set.

(4) Turn the ignition switch to the "LOCK" (OFF) position.

Q: Is the DTC set?

YES : Replace KOS-ECU and register the ID codes. (Refer to [P.42B-11](#).)

NO : The trouble can be an intermittent malfunction (Refer to GROUP 00 –How to use Troubleshooting/inspection Service Points –How to Cope with Intermittent Malfunction [P.00-15](#)).

DTC U0245: Audio visual navigation unit CAN timeout**CAUTION**

- If DTC U0245 is set, be sure to diagnose the CAN bus line.
- When replacing the ECU, always check that the communication circuit is normal.

DIAGNOSTIC FUNCTION

When the signals from audio visual navigation unit cannot be received, the KOS-ECU sets DTC U0245.

TROUBLESHOOTING HINTS

- The CAN bus line may be defective.
- The KOS-ECU may be defective.
- The audio visual navigation unit may be defective.

DIAGNOSIS**Required Special Tools:**

- MB991958: Scan Tool (M.U.T.-III Sub Assembly)
 - MB991824: Vehicles Communication Interface (V.C.I.)
 - MB991827: M.U.T.-III USB Cable
 - MB991910: M.U.T.-III Main Harness A

STEP 1. Using scan tool MB991958, diagnose the CAN bus line.**CAUTION**

To prevent damage to scan tool MB991958, always turn the ignition switch to the "LOCK" (OFF) position before connecting or disconnecting scan tool MB991958.

- (1) Connect scan tool MB991958. Refer to "How to connect the Scan Tool (M.U.T.-III) P.42B-9."
- (2) Turn the ignition switch to the "ON" position.
- (3) Diagnose the CAN bus line.
- (4) Turn the ignition switch to the "LOCK" (OFF) position.

Q: Is the CAN bus line found to be normal?

YES : Go to Step 2.

NO : Repair the CAN bus line (Refer to GROUP 54C, Diagnosis P.54C-15).

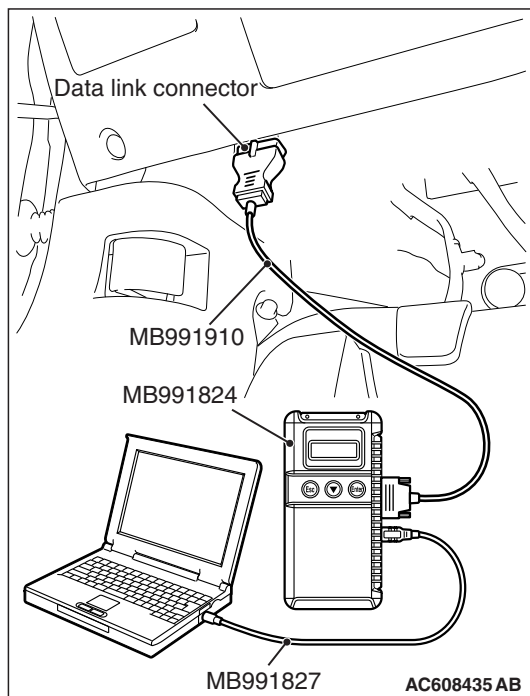
**STEP 2. Using scan tool MB991958, read the audio visual navigation unit diagnostic trouble code.**

Check if DTC is set to the audio visual navigation unit.

Q: Is the DTC set?

YES : Troubleshoot the MMCS. (Refer to GROUP 54A, Diagnosis <MMCS>.)

NO : Go to Step 3.

STEP 3. Using scan tool MB991958, read the other system diagnostic trouble code.

Check if DTC U0245 is set to the combination meter.

Q: Is the DTC set?

YES : Go to Step 4.

NO : Go to Step 5.

STEP 4. Recheck for diagnostic trouble code.

Check again if the DTC is set to the KOS-ECU.

(1) Erase the DTC.

(2) Turn the ignition switch from "LOCK" (OFF) position to "ON" position.

(3) Check if DTC is set.

(4) Turn the ignition switch to the "LOCK" (OFF) position.

Q: Is the DTC set?

YES : Replace the audio visual navigation unit.

NO : The trouble can be an intermittent malfunction (Refer to GROUP 00 –How to use Troubleshooting/inspection Service Points –How to Cope with Intermittent Malfunction [P.00-15](#)).

STEP 5. Recheck for diagnostic trouble code.

Check again if the DTC is set to the KOS-ECU.

(1) Erase the DTC.

(2) Turn the ignition switch from "LOCK" (OFF) position to "ON" position.

(3) Check if DTC is set.

(4) Turn the ignition switch to the "LOCK" (OFF) position.

Q: Is the DTC set?

YES : Replace KOS-ECU and register the ID codes. (Refer to [P.42B-11](#).)

NO : The trouble can be an intermittent malfunction (Refer to GROUP 00 –How to use Troubleshooting/inspection Service Points –How to Cope with Intermittent Malfunction [P.00-15](#)).

DTC U1412: Implausible Vehicle Speed Signal Received

⚠ CAUTION

If there is any problem in the CAN bus lines, an incorrect diagnostic trouble code may be set. Prior to this diagnosis, diagnose the CAN bus lines (Refer to GROUP 54C, Trouble code diagnosis [P.54C-15](#)).

DTC SET CONDITION

KOS-ECU receives the wheel speed information from ASC-ECU via the CAN-bus line. If KOS-ECU cannot receive the information about the wheel speed sensor from ASC-ECU, this code is set.

TROUBLESHOOTING HINTS

The most likely causes for this DTC to set are:

- Damaged wiring harness and connector
- Malfunction of ASC-ECU
- Malfunction of KOS-ECU
- Malfunction of ETACS-ECU

DIAGNOSIS**Required Special Tools:**

- MB991958 Scan Tool (M.U.T.-III Sub Assembly)
 - MB991824: Vehicle Communication Interface (V.C.I.)
 - MB991827 M.U.T.-III USB Cable
 - MB991910 M.U.T.-III Main Harness A

STEP 1. Using scan tool MB991958, diagnose the CAN bus lines.

Use scan tool to diagnose the CAN bus lines.

Q: Is the check result normal?

YES : Go to Step 3.

NO : Repair the CAN bus lines (Refer to GROUP 54C – CAN Bus Diagnostics table [P.54C-269](#)). On completion, go to Step 2.

STEP 2. Diagnostic trouble code recheck after resetting CAN bus lines

- (1) Turn the ignition switch to the "LOCK" (OFF) position.
- (2) Turn the ignition switch to the "ON" position.
- (3) Check if the DTC is set.
- (4) Turn the ignition switch to the "LOCK" (OFF) position.

Q: Is the DTC U1412 set?

YES : Go to Step 3.

NO : The procedure is complete.

STEP 3. Vehicle speed check by combination meter

When the vehicle is driven, check whether the proper vehicle speed is shown on the combination meter or not.

Q: Is the check result normal?

YES : Replace the KOS-ECU and register ID codes (Refer to [P.42B-11](#)). Then go to Step 6.

NO : Go to Step 4.

STEP 4. Check for other diagnostic trouble code.

Check if the diagnostic trouble code is set from ASC-ECU (Refer to GROUP 35C, diagnostic trouble code chart [P.35C-22](#)).

Q: Is the check result normal?

YES : Go to Step 5.

NO : Carry out the relevant troubleshooting. (Refer to GROUP 35C, diagnostic trouble code chart [P.35C-22](#)). Then go to Step 5.

STEP 5. Check for other diagnostic trouble code.

Check if the diagnostic trouble code is set from ETACS-ECU (Refer to GROUP 54A, ETACS –diagnostic trouble code chart [P.54A-646](#)).

Q: Is the check result normal?

YES : Diagnose the combination meter. (Refer to GROUP 54A, Combination meter –diagnostic trouble code chart [P.54A-32](#)) Go to Step 6.

NO : Carry out the relevant troubleshooting. (Refer to GROUP 54A, ETACS –diagnostic trouble code chart [P.54A-646](#)). Then go to Step 6.

STEP 6. Recheck for diagnostic trouble code.

- (1) Turn the ignition switch to the "LOCK" (OFF) position.
- (2) Turn the ignition switch to the "ON" position.
- (3) Check if the DTC is set.
- (4) Turn the ignition switch to the "LOCK" (OFF) position.

Q: Is the DTC U1412 set?

YES : Start over at Step 1.

NO : The procedure is complete.

DTC U1415: Coding not completed/Data fail**CAUTION**

- If DTC U1415 is set, diagnose the CAN bus lines.
- When replacing the ECU, always check that the communication circuit is normal.

DIAGNOSTIC FUNCTION

If the vehicle information data is not registered to the combination meter, the KOS-ECU sets DTC U1415.

JUDGMENT CRITERIA

With the global coding counter value "0," if all the global coding data (vehicle information) are not stored, the KOS-ECU determines that a problem has occurred.

TROUBLESHOOTING HINTS

- The CAN bus line may be defective.
- The KOS-ECU may be defective.
- The ETACS-ECU may be defective.

DIAGNOSIS**Required Special Tools:**

- MB991958: Scan Tool (M.U.T.-III Sub Assembly)
 - MB991824: Vehicle Communication Interface (V.C.I.)
 - MB991827: M.U.T.-III USB Cable
 - MB991910: M.U.T.-III Main Harness A

STEP 1. Using scan tool MB991958, diagnose the CAN bus line.**CAUTION**

To prevent damage to scan tool MB991958, always turn the ignition switch to the "LOCK" (OFF) position before connecting or disconnecting scan tool MB991958.

- (1) Connect scan tool MB991958. Refer to "How to connect the Scan Tool (M.U.T.-III) P.42B-9."
- (2) Turn the ignition switch to the "ON" position.
- (3) Diagnose the CAN bus line.
- (4) Turn the ignition switch to the "LOCK" (OFF) position.

Q: Is the CAN bus line found to be normal?

YES : Go to Step 2.

NO : Repair the CAN bus line (Refer to GROUP 54C, Diagnosis P.54C-15).

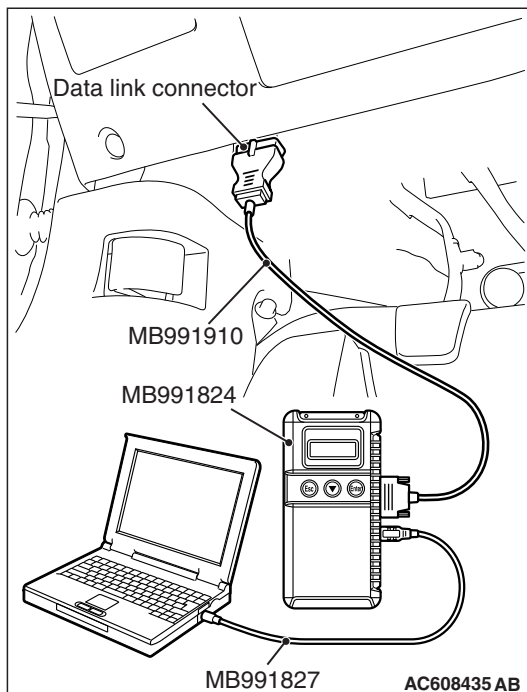

STEP 2. Using scan tool MB991958, read the ETACS-ECU diagnostic trouble code.

Check if a coding-related DTC is set to the ETACS-ECU.

Q: Is the DTC set?

YES : Troubleshoot the ETACS-ECU (Refer to GROUP 54A, Diagnosis [P.54A-646](#)).

NO : Go to Step 3.

STEP 3. Recheck for diagnostic trouble code.

Check again if the DTC is set to the KOS-ECU.

(1) Erase the DTC.

(2) Turn the ignition switch from "LOCK" (OFF) position to "ON" position.

(3) Check if DTC is set.

(4) Turn the ignition switch to the "LOCK" (OFF) position.

Q: Is the DTC set?

YES : Replace KOS-ECU and register the ID codes (Refer to [P.42B-11](#)).

NO : The trouble can be an intermittent malfunction (Refer to GROUP 00 –How to use Troubleshooting/inspection Service Points –How to Cope with Intermittent Malfunction [P.00-15](#)).

Code No.U1417 Implausible coding data

 **CAUTION**

- If DTC U1417 is set in KOS-ECU, always diagnose the CAN bus lines. If there is any fault in the CAN bus lines, an incorrect diagnostic trouble code may be set. In this case, the set diagnostic trouble code is not highly reliable.
- Before replacing the ECU, ensure that the communication circuit is normal.
- When diagnostic trouble code U1417 is set in KOS-ECU, the diagnostic trouble code may also be set in ETACS-ECU. When the diagnostic trouble code is set in ETACS-ECU, carry out the diagnosis of the diagnostic trouble code for ETACS-ECU first.

CIRCUIT OPERATION

KOS-ECU receives the vehicle information stored in the ETACS-ECU via CAN bus lines.

DTC SET CONDITIONS

KOS-ECU communicates with ETACS-ECU via CAN bus lines. This diagnostic trouble code is set when the vehicle information received from the ETACS-ECU is invalid.

PROBABLE CAUSES

- Malfunction of ETACS-ECU
- Engine control module malfunction
- ETACS-ECUs have been interchanged between two vehicles.
- KOS-ECU malfunction
- External noise interference
- WCMs have been interchanged between two vehicles.

DIAGNOSIS**Required Special Tools:**

- MB991958: Scan Tool (M.U.T.-III Sub Assembly)
 - MB991824: Vehicle Communication Interface (V.C.I.)
 - MB991827: M.U.T.-III USB Cable
 - MB991910: M.U.T.-III Main Harness A

STEP 1. Using scan tool MB991958, diagnose the CAN bus line.**⚠ CAUTION**

To prevent damage to scan tool MB991958, always turn the ignition switch to the "LOCK" (OFF) position before connecting or disconnecting scan tool MB991958.

- (1) Connect scan tool MB991958. Refer to "How to connect the Scan Tool (M.U.T.-III) P.42B-9."
- (2) Turn the ignition switch to the "ON" position.
- (3) Diagnose the CAN bus line.
- (4) Turn the ignition switch to the "LOCK" (OFF) position.

Q: Is the CAN bus line found to be normal?

YES : Go to Step 2.

NO : Repair the CAN bus line (Refer to GROUP 54C, Diagnosis P.54C-15).

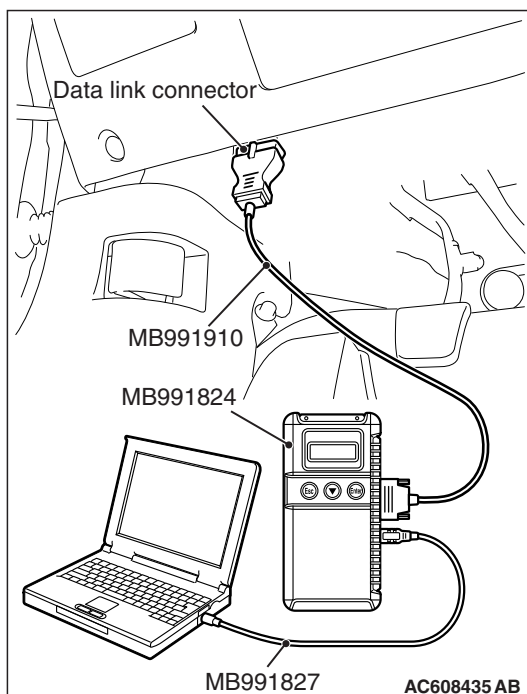

STEP 2. Using scan tool MB991958, read the other system diagnostic trouble code.

Check if DTC is set to the ETACS-ECU or engine control module.

Q: Is the DTC set?

YES (DTC is set to ETACS-ECU.) : Troubleshoot the ETACS (Refer to GROUP 54A –ETACS, Diagnosis [P.54A-646](#)).

YES (DTC is set to the engine control module.) : Troubleshoot the MFI system (Refer to GROUP 13A, Diagnosis [P.13A-48](#)).

NO : Go to Step 3.

STEP 3. Check part number of ETACS-ECU.

Check the part number of ETACS-ECU.

OK: 8637A313

Q: Is the check result normal?

YES : Go to Step 4.

NO : Replace ETACS-ECU.

STEP 4. Check part number of KOS-ECU.

Check the part number of KOS-ECU.

OK: 8637A305

Q: Is the check result normal?

YES : Go to Step 5.

NO : Replace KOS-ECU and register the ID codes (Refer to [P.42B-11](#)).

STEP 5. Recheck for diagnostic trouble code.

Check again if the DTC is set to the KOS-ECU.

(1) Erase the DTC.

(2) Turn the ignition switch from "LOCK" (OFF) position to "ON" position.

(3) Check if DTC is set.

(4) Turn the ignition switch to the "LOCK" (OFF) position.

Q: Is the DTC set?

YES : Replace KOS-ECU and register the ID codes (Refer to [P.42B-11](#)).

NO : The trouble can be an intermittent malfunction (Refer to GROUP 00 –How to use Troubleshooting/inspection Service Points –How to Cope with Intermittent Malfunction [P.00-15](#)).

DATA LIST REFERENCE TABLE

M1429605000125

Item No.	Scan tool MB991958 display	Check condition	Normal condition
1*	Received key data(ID)	-	Memorized keyless operation key ID
2	Received key data(button)	-	Switch display of the keyless operation key
3	Driver's door lock SW	Driver's door lock switch: ON	ON
		Driver's door lock switch: OFF	OFF
4	Driver's door unlock SW	Driver's door unlock switch: ON	ON
		Driver's door unlock switch: OFF	OFF
5	Passenger's door lock SW	Front passenger's door lock switch: ON	ON
		Front passenger's door lock switch: OFF	OFF
6	Passenger's door unlock SW	Front passenger's door unlock switch: ON	ON
		Front passenger's door unlock switch: OFF	OFF
7*	Tail gate SW lock	-	-
8	Tail gate SW unlock	Trunk lid opener switch: ON	ON
		Trunk lid opener switch: OFF	OFF
13	Number of registered IMMOB.key	-	Number of the keyless operation keys memorized
14	Memorized KOS keys	-	Number of the keyless operation keys memorized
21	Air pressure, Tire 1	-	-
22	Air pressure, Tire 2		
23	Air pressure, Tire 3		
24	Air pressure, Tire 4		
25*	Air pressure, Tire 5		
31	Acceleration, Tire 1	-	-
32	Acceleration, Tire 2		
33	Acceleration, Tire 3		
34	Acceleration, Tire 4		
35*	Acceleration, Tire 5		
36	Threshold of PRS. warning	The tire pressure is within the specified value range.	OFF
		The tire pressure is not within the specified value range.	ON

Item No.	Scan tool MB991958 display	Check condition	Normal condition
37	Threshold of PRS. warning release	The tire pressure is within the specified value range.	ON
		The tire pressure is not within the specified value range.	OFF
38	Number of registered TPMS ID	-	Number of stored TPMS
39	Ignition signal(CAN data)	Ignition switch: ON	ON
		Ignition switch: OFF	OFF
40	Ignition signal(Port input)	Ignition switch: ON	ON
		Ignition switch: OFF	OFF
41	VSS	Drive the vehicle	The scan tool and the speedometer readings are approximately the same
50	Registered ID reception, Tier1	Ignition switch: ON	Yes
		Ignition switch: OFF	No
51	Registered ID reception, Tier2	Ignition switch: ON	Yes
		Ignition switch: OFF	No
52	Registered ID reception, Tier3	Ignition switch: ON	Yes
		Ignition switch: OFF	No
53	Registered ID reception, Tier4	Ignition switch: ON	Yes
		Ignition switch: OFF	No
54*	Registered ID reception, Tier5	-	-
61	Air pressure, Tire1(not adjusted)	-	-
62	Air pressure, Tire2(not adjusted)		
63	Air pressure, Tire3(not adjusted)		
64	Air pressure, Tire4(not adjusted)		
65*	Air pressure, Tire5(not adjusted)		

NOTE: * shows that it is displayed but not used.

ACTUATOR TEST TABLE

M1429605100058

Item No.	Check item	Driven component
1	Outer tone alarm	Forces to sound the outer tone alarm.

TROUBLE SYMPTOM CHART

Trouble symptom	Inspection procedure number	Reference page
Scan tool cannot communicate with KOS-ECU.	1	P.42B-152
The keyless operation key cannot be registered using scan tool.	2	P.42B-154
Abnormality in KOS-ECU power supply and ground circuits.	3	P.42B-164
Keyless operation warning display does not disappear.	4	P.42B-167
IG knob will not turn (keyless operation is not recognized).	5	P.42B-169
The engine will not start with KOS (IG knob operates normally).	6	P.42B-178
Engine does not start with emergency key (cranking but no initial combustion).	7	P.42B-180
No door will be locked or unlocked by operating a lock switch on any door, or by touching the unlock sensor.	8	P.42B-182
Driver's door lock switch does not work.	9	P.42B-186
Driver's door unlock sensor does not work.	10	P.42B-189
Front passenger's door lock switch does not work.	11	P.42B-193
Front passenger's door unlock sensor does not work.	12	P.42B-196
Trunk lid opener switch does not work.	13	P.42B-200
Keyless entry system does not work.	14	P.42B-204
KOS timer lock function does not work.	15	P.42B-210
Keyless entry hazard light answerback function, the dome light answerback function or the horn answerback function does not work normally.	16	P.42B-212
The trunk is not opened when the keyless operation key "TRUNK" button is operated.	17	P.42B-215
Outer tone alarm does not sound.	18	P.42B-220
Power door locks with selective unlocking does not work.	19	P.42B-224

SYMPTOM PROCEDURES

Inspection Procedure 1: Scan tool cannot communicate with KOS-ECU.

CAUTION

Before replacing the ECU, ensure that the communication circuit is normal.

TECHNICAL DESCRIPTION (COMMENT)

If the scan tool cannot communicate with the KOS-ECU, the CAN bus lines may be defective. If the KOS-ECU does not work, the KOS-ECU or the power supply circuit may be defective.

TROUBLESHOOTING HINTS

- Malfunction of the power supply or ground of KOS-ECU
- Malfunction of CAN bus line

DIAGNOSIS

Required Special Tools:

- MB991958 Scan Tool (M.U.T.-III Sub Assembly)
 - MB991824: Vehicles Communication Interface (V.C.I.)
 - MB991827 M.U.T.-III USB Cable
 - MB991910 M.U.T.-III Main Harness A

STEP 1. Using scan tool MB991958, diagnose the CAN bus line.

⚠ CAUTION

To prevent damage to scan tool MB991958, always turn the ignition switch to the "LOCK" (OFF) position before connecting or disconnecting scan tool MB991958.

- (1) Connect scan tool MB991958. Refer to "How to connect the Scan Tool (M.U.T.-III) P.42B-9."
- (2) Turn the ignition switch to the "ON" position.
- (3) Diagnose the CAN bus line.
- (4) Turn the ignition switch to the "LOCK" (OFF) position.

Q: Is the CAN bus line found to be normal?

YES : Go to Step 2.

NO : Repair the CAN bus line (Refer to GROUP 54C, Diagnosis P.54C-15).

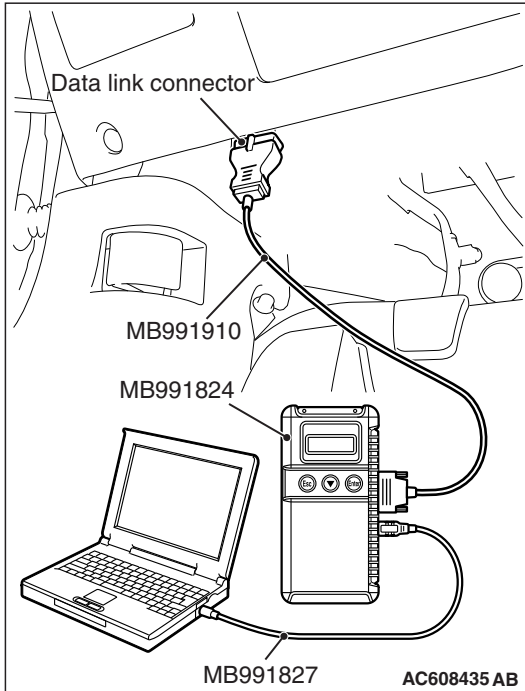

STEP 2. Check the power supply circuit and the ground circuit to WCM.

Refer to Inspection Procedure 3 "Abnormality in KOS-ECU power supply and ground circuits" P.42B-164.

Q: Is the power supply circuit and the ground circuit to KOS-ECU in good condition ?

YES : Go to Step 3.

NO : Repair the power supply circuit and the ground circuit to KOS-ECU.

STEP 3. Retest the system

Check if scan tool can communicate with KOS-ECU.

Q: Does the scan tool cannot with KOS-ECU?

YES : The trouble can be an intermittent malfunction (Refer to GROUP 00 –How to use Troubleshooting/inspection Service Points –How to Cope with Intermittent Malfunction P.00-15).

NO : Replace KOS-ECU and register the ID codes (Refer to P.42B-11).

Inspection Procedure 2: The keyless operation key cannot be registered using scan tool.

Receiver Antenna Module and KOS-ECU Circuit

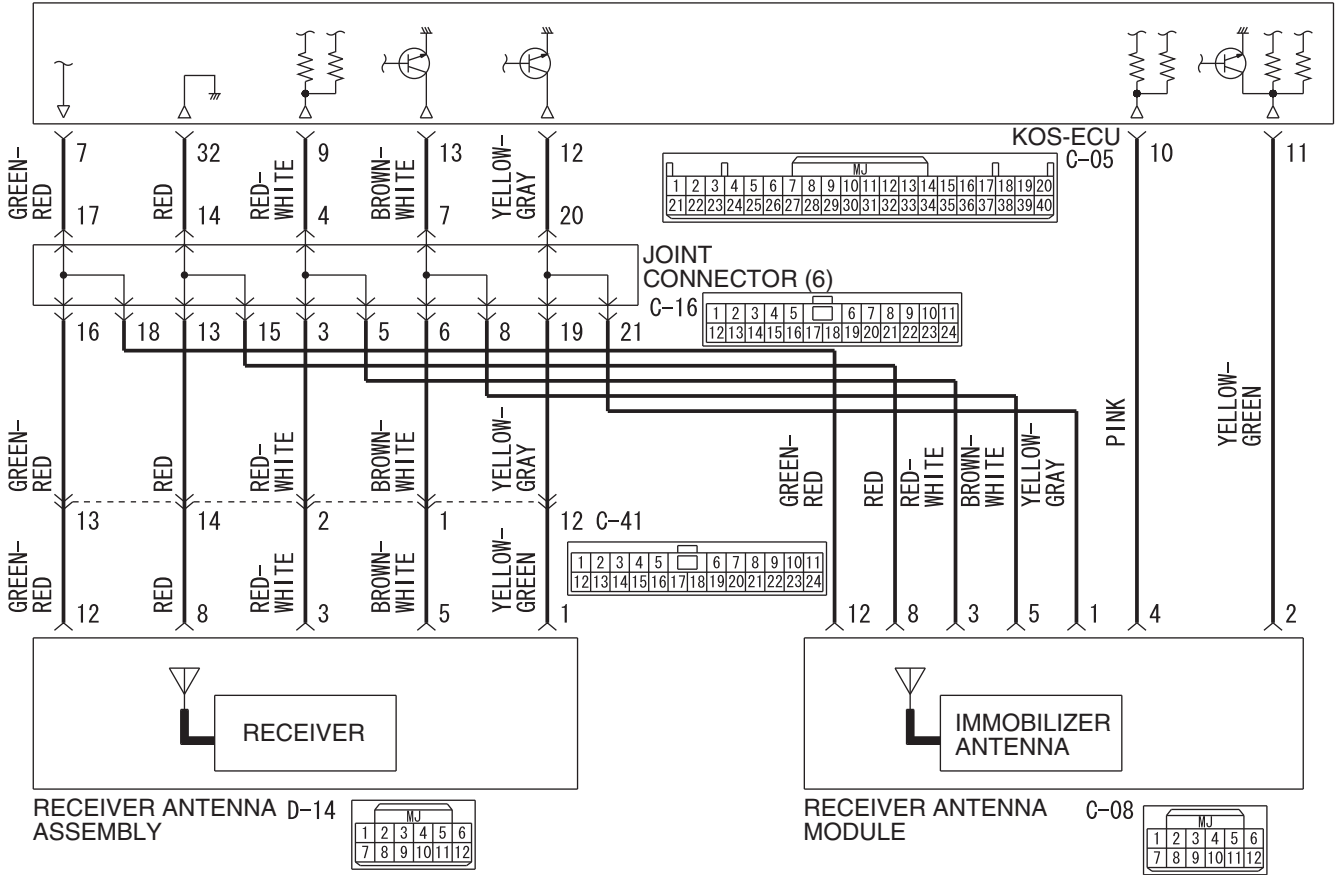

W8H42M003A

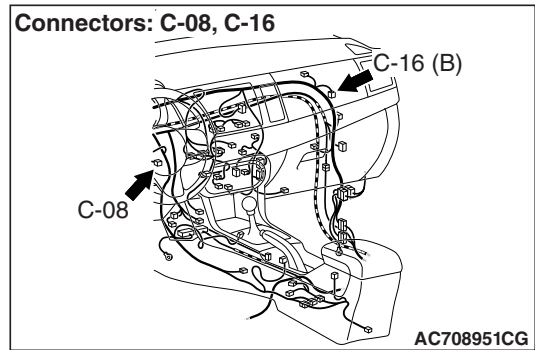
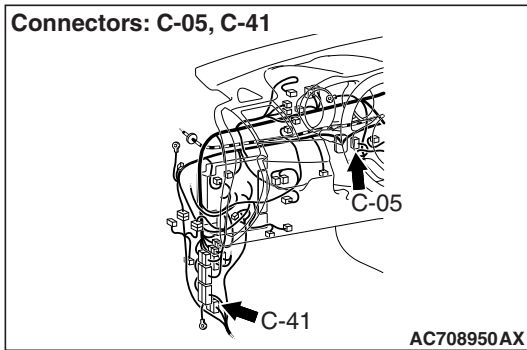

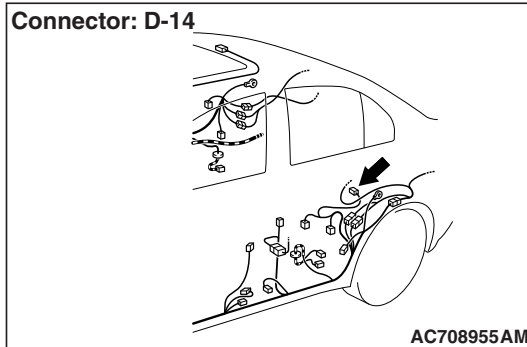

TECHNICAL DESCRIPTION (COMMENT)

If only some keyless operation keys cannot be registered, the keyless operation key itself may be faulty. If no keyless operation key can be registered, the key assembly may have already been registered for another vehicle, or the KOS-ECU may be faulty.

TROUBLESHOOTING HINTS

- Malfunction of the keyless operation key
- Damaged wiring harness and connectors
- Malfunction of KOS-ECU
- Ignition key registered for other vehicle

DIAGNOSIS

Required Special Tools:

- MB991958 Scan Tool (M.U.T.-III Sub Assembly)
 - MB991824: Vehicle Communication Interface (V.C.I.)
 - MB991827 M.U.T.-III USB Cable
 - MB991910 M.U.T.-III Main Harness A (Vehicles with CAN communication system)

STEP 1. Check the keyless operation key inserted in the key cylinder for interference.

Q: Are there other keyless operation keys or anything that interferes with the communication (things that generate radio waves such as magnets and an air-cleaning device that has a power plug) near the keyless operation key inserted in the key cylinder?

YES : Move away or remove other keyless operation keys or things that interfere with the communication (things that generate radio waves such as magnets and an air-cleaning device that has a power plug) near the keyless operation key. Then, go to step 2.

NO : Go to Step 3.

STEP 2. Retest the system

Check that the keyless operation key can be registered.

Q: Is the keyless operation key that cannot be registered using scan tool?

YES : Go to Step 3.

NO : The procedure is complete.

STEP 3. Check which keyless operation key cannot be registered.

Q: Can any one of the keyless operation keys be registered?

YES (Only some keys) : Replace the key that cannot be registered and register the ID codes (Refer to [P.42B-227](#)). After registering the ID codes, go to Step 5.

NO (All keys) : Go to Step 4.

STEP 4. Retest the system

Check the scan tool screen when the key was not able to be registered.

Q: Is the error message of scan tool screen "Abnormality in key" ?

YES (Abnormality in key) : Carry out DTC B1A25: Key ID unmatched and DTC B1A35: Transponder read error (Refer to [P.42B-32](#) <B1A25>, [P.42B-36](#) <B1A35>). Then, go to Step 6.

NO (ECU internal error) : Replace KOS-ECU and register the ID codes (Refer to [P.42B-11](#)).

STEP 5. Retest the system

Check that the keyless operation key can be registered.

Q: Is the keyless operation key that cannot be registered using scan tool?

YES : Replace KOS-ECU and register the ID codes (Refer to [P.42B-11](#)).

NO : The procedure is complete.

STEP 6. Retest the system

Check that the keyless operation key can be registered.

Q: Is the keyless operation key that cannot be registered using scan tool?

YES : Go to Step 7.

NO : The procedure is complete.

STEP 7. Check receiver antenna module connector C-08, receiver antenna assembly connector D-14, KOS-ECU connector C-05, joint connector (6) C-16 and intermittent connector C-41 for loose, corroded or damaged terminals, or terminals pushed back in the connector.

Q: Is the receiver antenna module connector C-08, receiver antenna assembly connector D-14, KOS-ECU connector C-05, joint connector (6) C-16 and intermittent connector C-41 in good condition?

YES : Go to Step 8.

NO : Repair the defective connector.

STEP 8. Check the wiring harness between the receiver antenna assembly connector D-14 (terminal Nos.1, 8, 12, 3, 5) and the KOS-ECU connector C-05 (terminal Nos.12, 32, 7, 9, 13) for open circuit.

- (1) Disconnect receiver antenna assembly connector D-14 and KOS-ECU connector C-05, and check the wiring harness.
- (2) Check the wiring harness between receiver antenna assembly connector D-14 (terminal No.1) and KOS-ECU connector C-05 (terminal No.12)

OK: Continuity exists (2 Ω or less)

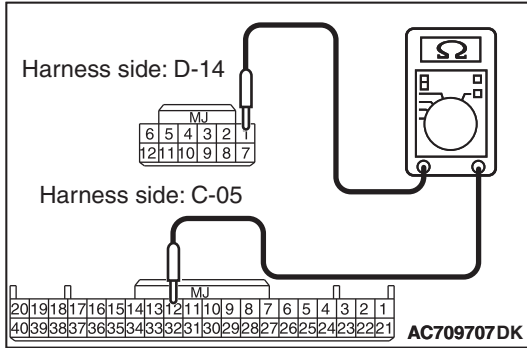

- (3) Check the wiring harness between receiver antenna assembly connector D-14 (terminal No.8) and KOS-ECU connector C-05 (terminal No.32)

OK: Continuity exists (2 Ω or less)

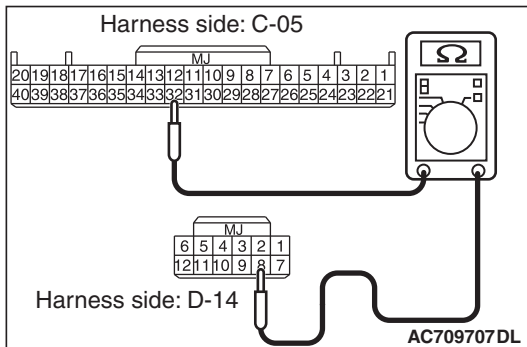

- (4) Check the wiring harness between receiver antenna assembly connector D-14 (terminal No.12) and KOS-ECU connector C-05 (terminal No.7)

OK: Continuity exists (2 Ω or less)

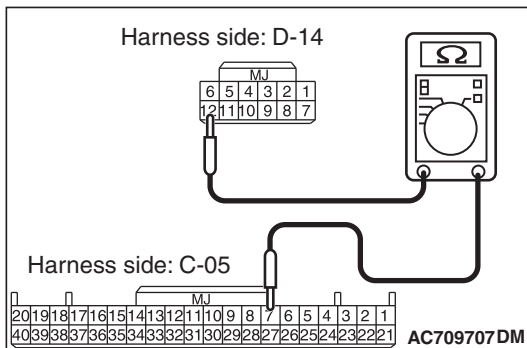

- (5) Check the wiring harness between receiver antenna assembly connector D-14 (terminal No.3) and KOS-ECU connector C-05 (terminal No.9)

OK: Continuity exists (2 Ω or less)

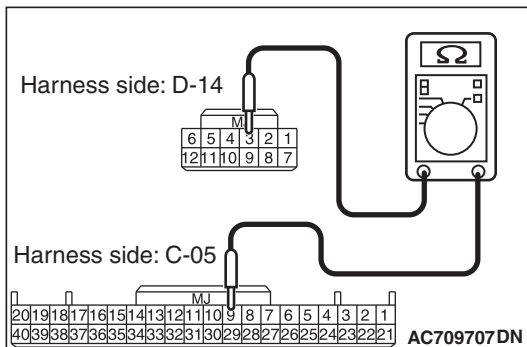

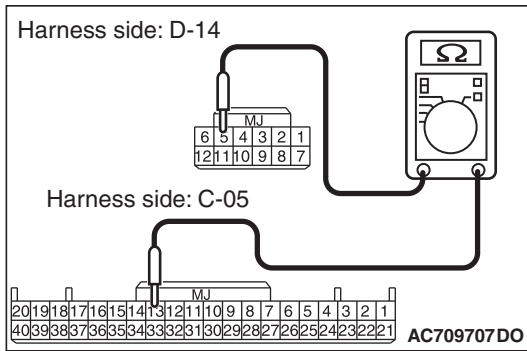

- (6) Check the wiring harness between receiver antenna assembly connector D-14 (terminal No.5) and KOS-ECU connector C-05 (terminal No.13)

OK: Continuity exists (2 Ω or less)

- Q: Is the wiring harness between receiver antenna assembly connector D-14 (terminal Nos.1, 8, 12, 3, 5) and the KOS-ECU connector C-05 (terminal Nos.12, 32, 7, 9, 13) in good condition?**

YES : Go to Step 9.

NO (receiver antenna assembly connector D-14 terminal No.1 –KOS-ECU connector C-05 terminal No.12.) :

Repair the wiring harness between receiver antenna assembly connector D-14 (terminal No.1) and the KOS-ECU connector C-05 (terminal No.12).

NO (receiver antenna assembly connector D-14 terminal No.8 –KOS-ECU connector C-05 terminal No.32.) :

Repair the wiring harness between receiver antenna assembly connector D-14 (terminal No.8) and the KOS-ECU connector C-05 (terminal No.32).

NO (receiver antenna assembly connector D-14 terminal No.12 –KOS-ECU connector C-05 terminal No.7.) :

Repair the wiring harness between receiver antenna assembly connector D-14 (terminal No.12) and the KOS-ECU connector C-05 (terminal No.7).

NO (receiver antenna assembly connector D-14 terminal No.3 –KOS-ECU connector C-05 terminal No.9.) :

Repair the wiring harness between receiver antenna assembly connector D-14 (terminal No.3) and the KOS-ECU connector C-05 (terminal No.9).

NO (receiver antenna assembly connector D-14 terminal No.5 –KOS-ECU connector C-05 terminal No.13.) :

Repair the wiring harness between receiver antenna assembly connector D-14 (terminal No.5) and the KOS-ECU connector C-05 (terminal No.13).

STEP 9. Check the wiring harness between the receiver antenna assembly connector D-14 (terminal Nos.1, 8, 12, 3, 5) and the ground for short circuit.

(1) Disconnect receiver antenna assembly connector D-14, and check the wiring harness.

(2) Check the wiring harness between receiver antenna assembly connector D-14 (terminal No.1) and ground

OK: No continuity

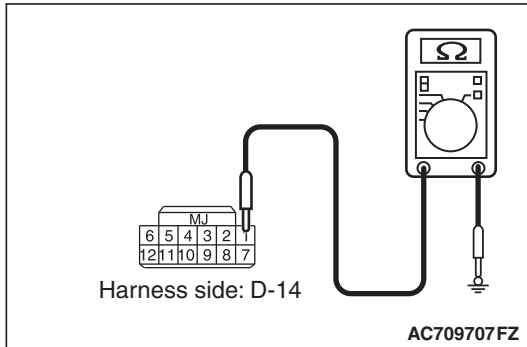

(3) Check the wiring harness between receiver antenna assembly connector D-14 (terminal No.8) and ground

OK: No continuity

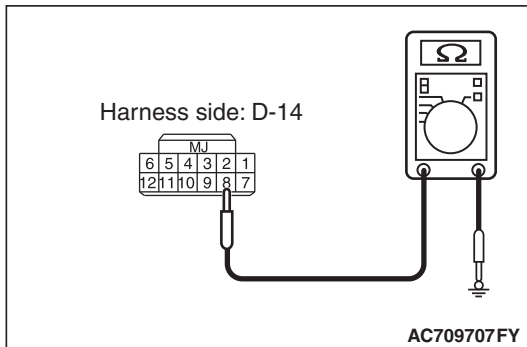

(4) Check the wiring harness between receiver antenna assembly connector D-14 (terminal No.12) and ground

OK: No continuity

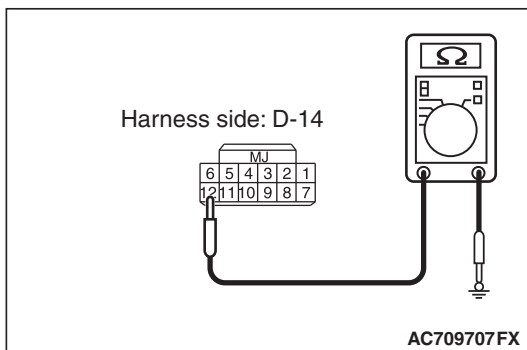

(5) Check the wiring harness between receiver antenna assembly connector D-14 (terminal No.3) and ground

OK: No continuity

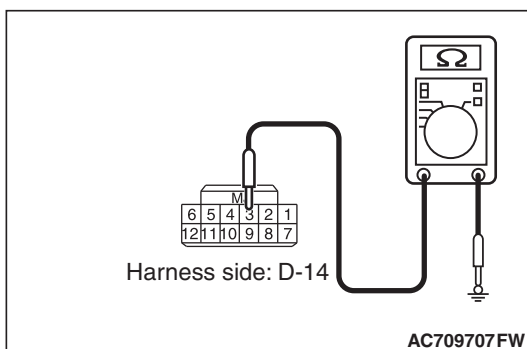

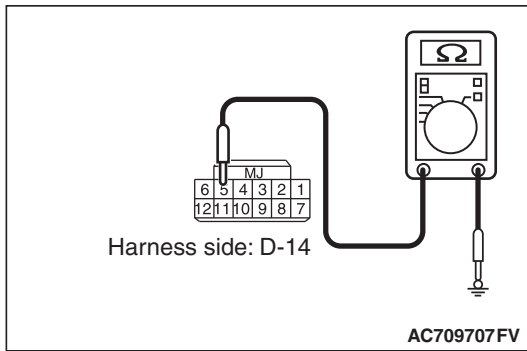

- (6) Check the wiring harness between receiver antenna assembly connector D-14 (terminal No.5) and ground

OK: No continuity

- Q: Is the wiring harness between receiver antenna assembly connector D-14 (terminal Nos.1, 8, 12, 3, 5) and the ground in good condition?**

YES : Go to Step 10.

NO (receiver antenna assembly connector D-14 terminal No.1 –ground.) : Repair the wiring harness between receiver antenna assembly connector D-14 (terminal No.1) and the ground.

NO (receiver antenna assembly connector D-14 terminal No.8 –ground.) : Repair the wiring harness between receiver antenna assembly connector D-14 (terminal No.8) and the ground.

NO (receiver antenna assembly connector D-14 terminal No.12 –ground.) : Repair the wiring harness between receiver antenna assembly connector D-14 (terminal No.12) and the ground.

NO (receiver antenna assembly connector D-14 terminal No.3 –ground.) : Repair the wiring harness between receiver antenna assembly connector D-14 (terminal No.3) and the ground.

NO (receiver antenna assembly connector D-14 terminal No.5 –ground.) : Repair the wiring harness between receiver antenna assembly connector D-14 (terminal No.5) and the ground.

STEP 10. Replace the receiver antenna assembly, and retest the system.

Check that the keyless operation key can be registered.

- Q: Is the keyless operation key that cannot be registered using scan tool?**

YES : Go to Step 11.

NO : The procedure is complete.

STEP 11. Check the wiring harness between the receiver antenna module connector C-08 (terminal Nos. 2, 1, 8, 12) and the KOS-ECU connector C-05 (terminal Nos. 11, 12, 32, 7) for open circuit.

- (1) Disconnect receiver antenna module connector C-08 and KOS-ECU connector C-05, and check the wiring harness.
- (2) Check the wiring harness between receiver antenna module connector C-08 (terminal No.2) and KOS-ECU connector C-05 (terminal No.11)

OK: Continuity exists (2 Ω or less)

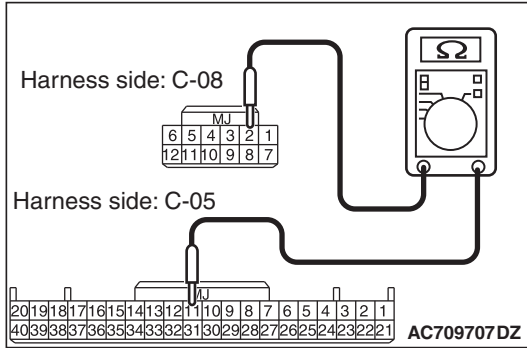

- (3) Check the wiring harness between receiver antenna module connector C-08 (terminal No.1) and KOS-ECU connector C-05 (terminal No.12)

OK: Continuity exists (2 Ω or less)

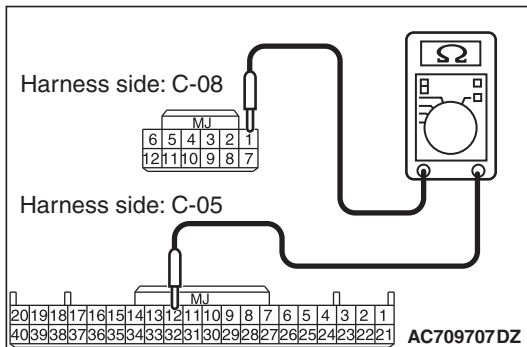

- (4) Check the wiring harness between receiver antenna module connector C-08 (terminal No.8) and KOS-ECU connector C-05 (terminal No.32)

OK: Continuity exists (2 Ω or less)

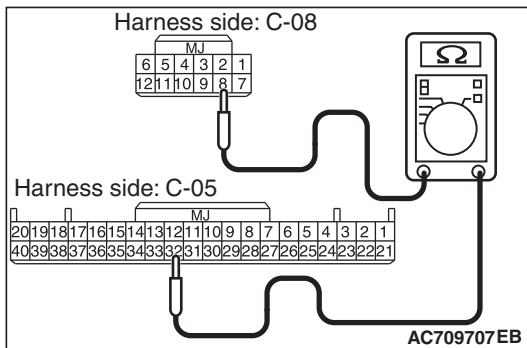

- (5) Check the wiring harness between receiver antenna module connector C-08 (terminal No.12) and KOS-ECU connector C-05 (terminal No.7)

OK: Continuity exists (2 Ω or less)

Q: Is the wiring harness between receiver antenna module connector C-08 (terminal Nos. 2, 1, 8, 12) and the KOS-ECU connector C-05 (terminal Nos. 11, 12, 32, 7) in good condition?

YES : Go to Step 12.

NO (receiver antenna module connector C-08 terminal No.2 –KOS-ECU connector C-05 terminal No.11.) :

Repair the wiring harness between receiver antenna module connector C-08 (terminal No. 2) and the KOS-ECU connector C-05 (terminal No. 11).

NO (receiver antenna module connector C-08 terminal No.1 –KOS-ECU connector C-05 terminal No.12.) :

Repair the wiring harness between receiver antenna module connector C-08 (terminal No. 1) and the KOS-ECU connector C-05 (terminal No. 12).

NO (receiver antenna module connector C-08 terminal No.8 –KOS-ECU connector C-05 terminal No.32.) :

Repair the wiring harness between receiver antenna module connector C-08 (terminal No. 8) and the KOS-ECU connector C-05 (terminal No. 32).

NO (receiver antenna module connector C-08 terminal No.12 –KOS-ECU connector C-05 terminal No.7.) :

Repair the wiring harness between receiver antenna module connector C-08 (terminal No. 12) and the KOS-ECU connector C-05 (terminal No. 7).

STEP 12. Check the wiring harness between the receiver antenna module connector C-08 (terminal Nos. 2, 1, 8, 12) and the ground for short circuit.

- (1) Disconnect receiver antenna module connector C-08, and check the wiring harness.
- (2) Check the wiring harness between receiver antenna module connector C-08 (terminal No.2) and ground

OK: No continuity

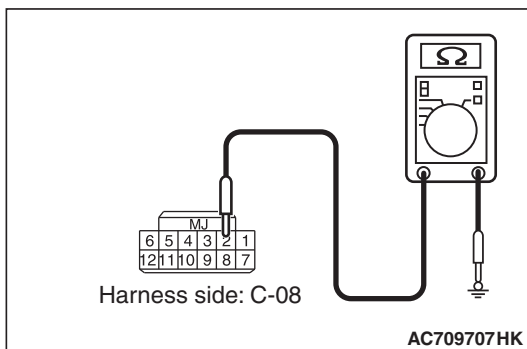

- (3) Check the wiring harness between receiver antenna module connector C-08 (terminal No.1) and ground

OK: No continuity

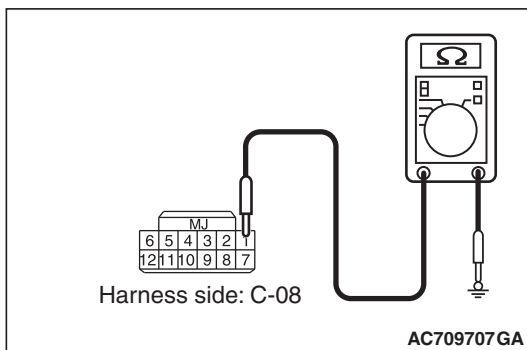

- (4) Check the wiring harness between receiver antenna module connector C-08 (terminal No.8) and ground

OK: No continuity

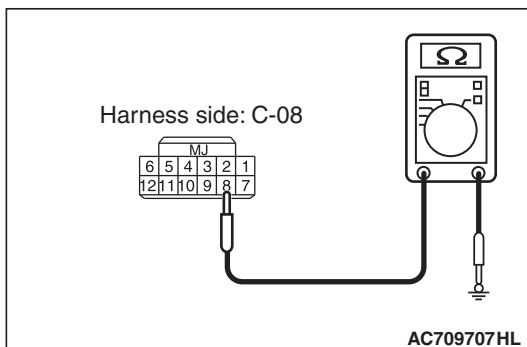

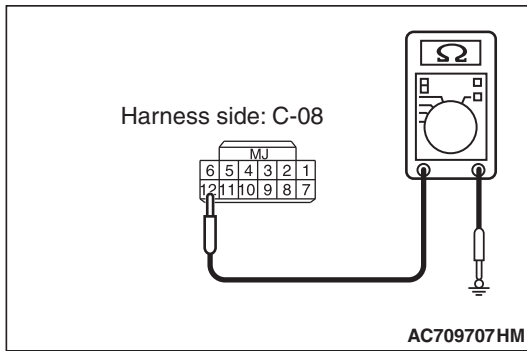

- (5) Check the wiring harness between receiver antenna module connector C-08 (terminal No.12) and ground

OK: No continuity

Q: Is the wiring harness between receiver antenna module connector C-08 (terminal Nos. 2, 1, 8, 12) and the ground in good condition?

YES : Go to Step 13.

NO (receiver antenna module connector C-08 terminal No.2 –ground.) : Repair the wiring harness between receiver antenna module connector C-08 (terminal No. 2) and the ground.

NO (receiver antenna module connector C-08 terminal No.1 –ground.) : Repair the wiring harness between receiver antenna module connector C-08 (terminal No. 1) and the ground.

NO (receiver antenna module connector C-08 terminal No.8 –ground.) : Repair the wiring harness between receiver antenna module connector C-08 (terminal No. 8) and the ground.

NO (receiver antenna module connector C-08 terminal No.12 –ground.) : Repair the wiring harness between receiver antenna module connector C-08 (terminal No. 12) and the ground.

STEP 13. Replace the receiver antenna module, and retest the system.

Check that the keyless operation key can be registered.

Q: Is the keyless operation key that cannot be registered using scan tool?

YES : Replace KOS-ECU and register the ID codes (Refer to [P.42B-11](#)).

NO : The procedure is complete.

Inspection Procedure 3: Abnormality in KOS-ECU power supply and ground circuits

CAUTION

Before replacing the ECU, ensure that the power supply circuit, the ground circuit and the communication circuit are normal.

KOS-ECU Power Supply Circuit

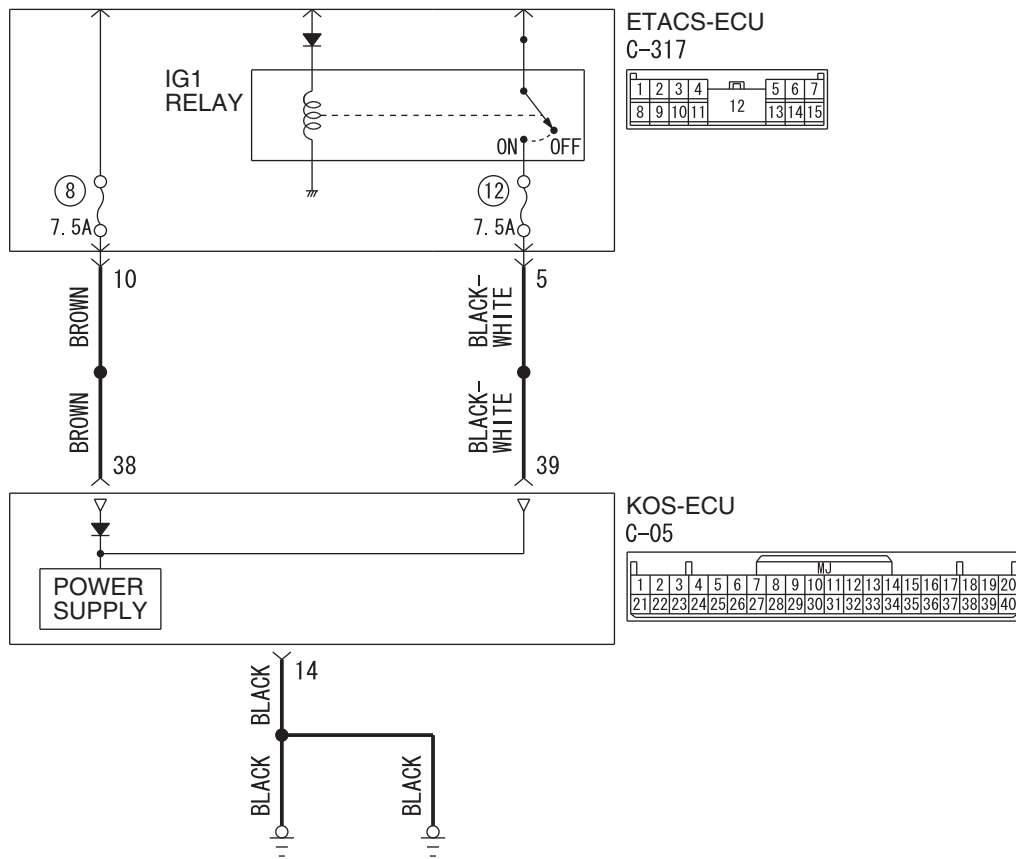

W8H42M001A

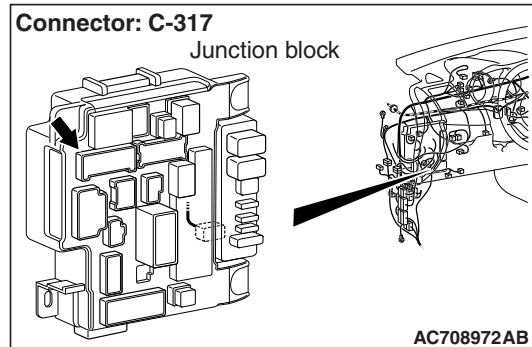
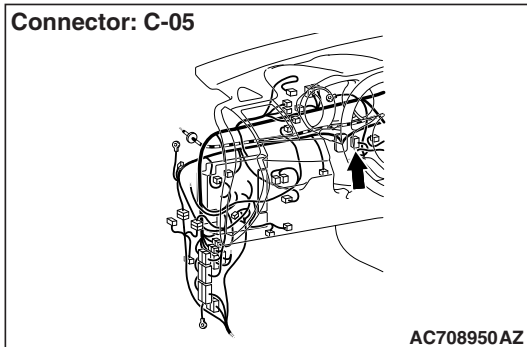

TECHNICAL DESCRIPTION (COMMENT)

If the KOS-ECU does not work at all or if the KOS-ECU cannot communicate with the scan tool, the KOS-ECU power supply or the ground circuit may be defective.

TROUBLESHOOTING HINTS

- Damaged wiring harness and connectors
- Malfunction of KOS-ECU

DIAGNOSIS

Required Special Tools:

- MB992006: Extra fine probe
- MB991223: Harness set

STEP 1. Check KOS-ECU connector C-05 and ETACS-ECU connector C-317 for loose, corroded or damaged terminals, or terminals pushed back in the connector.

Q: Is the KOS-ECU connector C-05 and ETACS-ECU connector C-317 in good condition?

YES : Go to Step 2.

NO : Repair the defective connector.

STEP 2. Check the wiring harness between the KOS-ECU connector C-05 (terminal No.38, 39) and the ETACS-ECU connector C-317 (terminal No.10, 5) for open circuit.

- (1) Disconnect KOS-ECU connector C-05 and ETACS-ECU connector C-317, and check the wiring harness.
- (2) Check the wiring harness between KOS-ECU connector C-05 (terminal No.38) and ETACS-ECU connector C-317 (terminal No.10)

OK: Continuity exists (2 Ω or less)

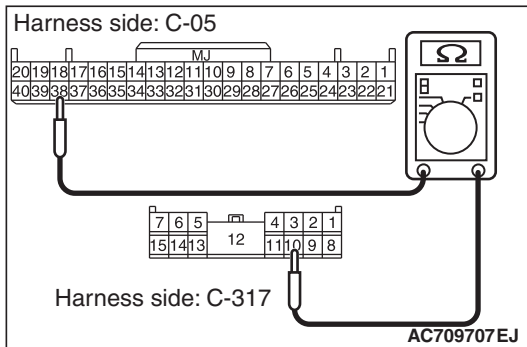

- (3) Check the wiring harness between KOS-ECU connector C-05 (terminal No.39) and ETACS-ECU connector C-317 (terminal No.5)

OK: Continuity exists (2 Ω or less)

Q: Is the wiring harness between KOS-ECU connector C-05 (terminal No.38, 39) and the ETACS-ECU connector C-317 (terminal No.10, 5) in good condition?

YES : Go to Step 3.

NO : Repair the wiring harness between KOS-ECU connector C-05 (terminal No.38, 39) and the ETACS-ECU connector C-317 (terminal No.10, 5).

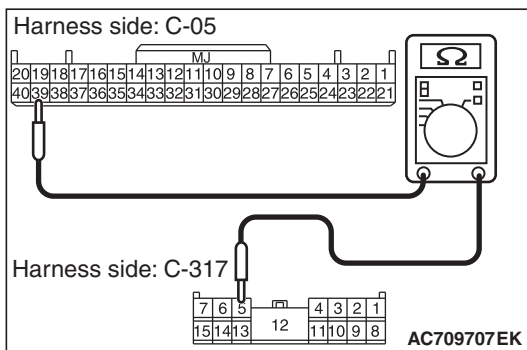

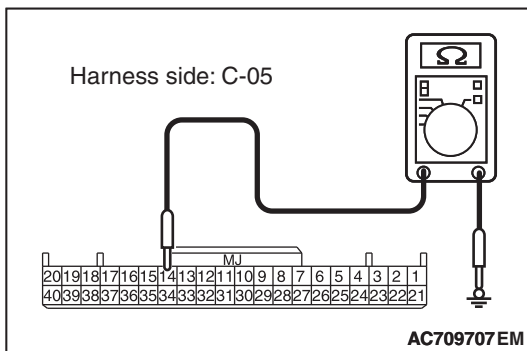
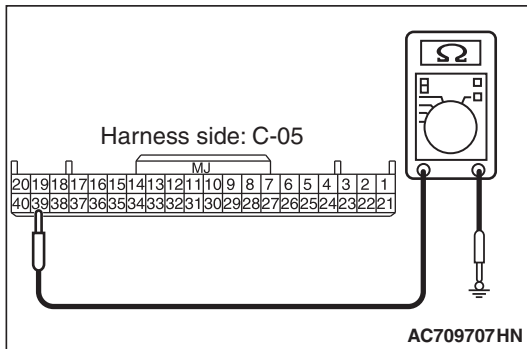
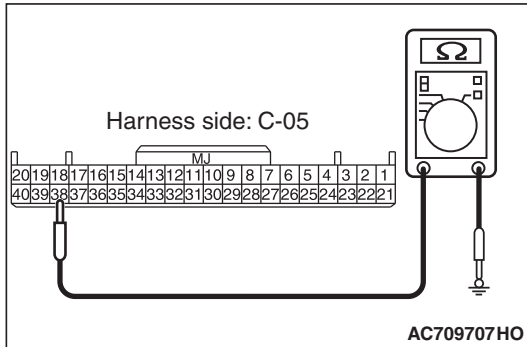

STEP 3. Check the wiring harness between the KOS-ECU connector C-05 (terminal No.38, 39) and the ground for short circuit.

- (1) Disconnect KOS-ECU connector C-05, and check the wiring harness.
- (2) Check the wiring harness between KOS-ECU connector C-05 (terminal No.38) and ground

OK: No continuity

- (3) Check the wiring harness between KOS-ECU connector C-05 (terminal No.39) and ground

OK: No continuity

Q: Is the wiring harness between KOS-ECU connector C-05 (terminal No.38, 39) and the ground in good condition?

YES : Go to Step 4.

NO : Repair the wiring harness between KOS-ECU connector C-05 (terminal No.38, 39) and the ground.

STEP 4. Check the wiring harness between the KOS-ECU connector C-05 and the ground for open circuit.

- (1) Disconnect KOS-ECU connector C-05, and check the wiring harness.
- (2) Check the wiring harness between KOS-ECU connector C-05 (terminal No.14) and ground.

OK: Continuity exists (2 Ω or less)

Q: Is the wiring harness between KOS-ECU connector C-05 and the ground in good condition?

YES : Go to Step 5.

NO : Repair the wiring harness between KOS-ECU connector C-07 and ground.

STEP 5. Retest the system

Q: Does the abnormality in KOS-ECU power supply and ground circuits in good condition?

YES : The trouble can be an intermittent malfunction (Refer to GROUP 00, How to use Troubleshooting/inspection Service Points - How to Cope with Intermittent Malfunction [P.00-15](#)).

NO : Replace KOS-ECU and register the ID codes (Refer to [P.42B-11](#)).

Inspection Procedure 4: Keyless operation warning display does not disappear.

CAUTION

Before replacing the ECU, ensure that the power supply circuit, the ground circuit and the communication circuit are normal.

TROUBLESHOOTING HINTS

- Malfunction of CAN bus line
- Malfunction of combination meter
- Damaged wiring harness and connectors
- Malfunction of the KOS-ECU

DIAGNOSIS

Required Special Tools:

- MB991958: Scan Tool (M.U.T.-III Sub Assembly)
 - MB991824: Vehicles Communication Interface (V.C.I.)
 - MB991827: M.U.T.-III USB Cable
 - MB991910: M.U.T.-III Main Harness A

STEP 1. Using scan tool MB991958, read the diagnostic trouble code.

Check if DTC B2415 is set to the KOS-ECU.

CAUTION

To prevent damage to scan tool MB991958, always turn the ignition switch to the "LOCK" (OFF) position before connecting or disconnecting scan tool MB991958.

- (1) Connect scan tool MB991958. Refer to "How to connect scan tool (M.U.T.-III) P.42B-9."
- (2) Turn the ignition switch to the "ON" position.
- (3) Check if DTC is set.
- (4) Turn the ignition switch to the "LOCK" (OFF) position.

Q: Is DTC B2415 set?

YES : Refer to P.42B-97.

NO : Go to Step 2.

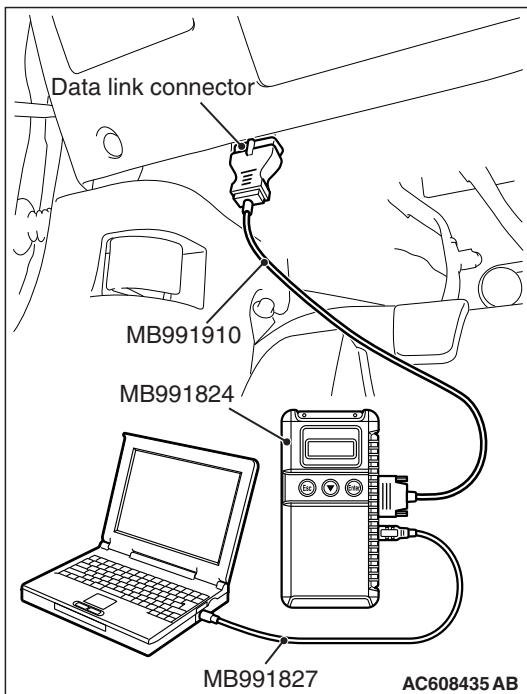

STEP 2. Using scan tool MB991958, read the combination meter diagnostic trouble code.

Check if DTC is set in the combination meter.

Q: Is the DTC set?

YES : Troubleshoot the combination meter. (Refer to GROUP 54A, Diagnosis P.54A-32).

NO : Go to Step 3.

STEP 3. Using scan tool MB991958, read the KOS-ECU trouble code.

Check if DTC is set to the KOS-ECU.

Q: Is the DTC set?

YES : Refer to [P.42B-23](#).

NO : Go to Step 4.

STEP 4. Check of the troubles.

Check that the keyless operation warning display turns OFF unless the flashing or illumination conditions are met.

Q: Does the warning display operate properly?

YES : The trouble can be an intermittent malfunction (Refer to GROUP 00 –How to use Troubleshooting/inspection Service Points –How to Cope with Intermittent Malfunction [P.00-15](#)).

NO : Replace KOS-ECU and register the ID codes. (Refer to [P.42B-11](#)).

Inspection Procedure 5: IG knob will not turn (keyless operation is not recognized).

CAUTION

Before replacing the ECU, ensure that the communication circuit is normal.

KOS-ECU System Circuit

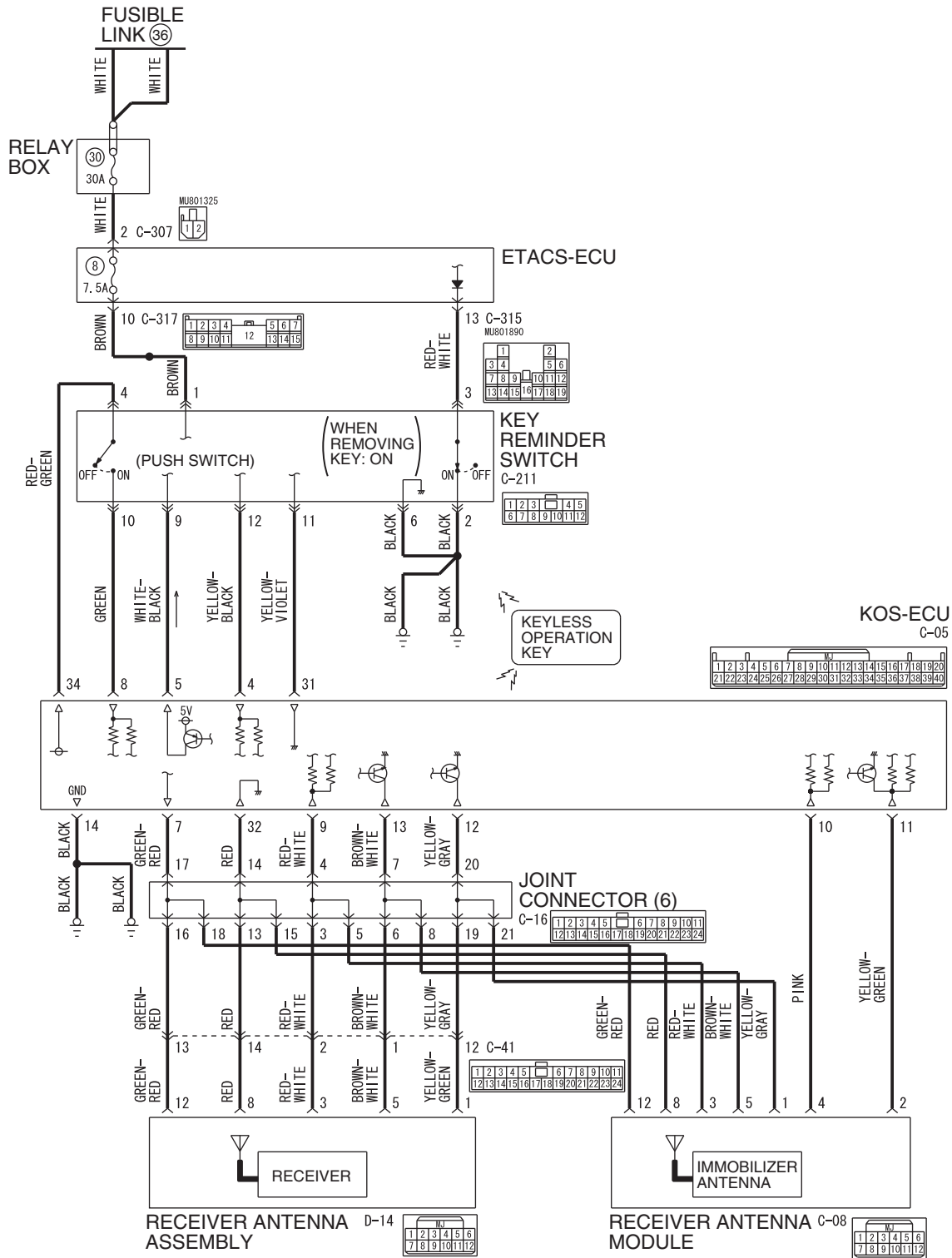

Connectors: C-05, C-41

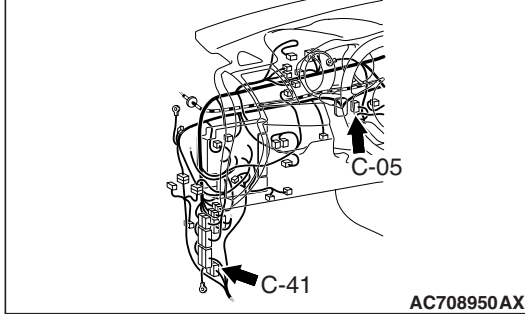

Connector: C-315

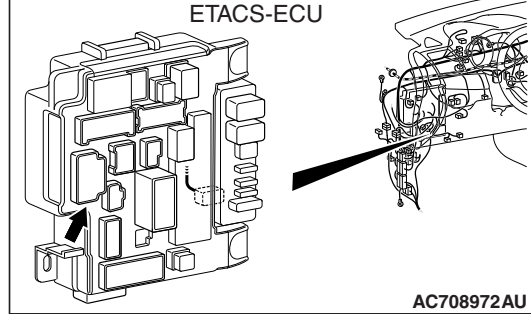

Connector: C-16

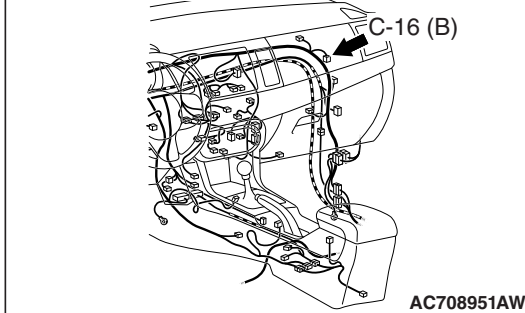

Connector: D-14

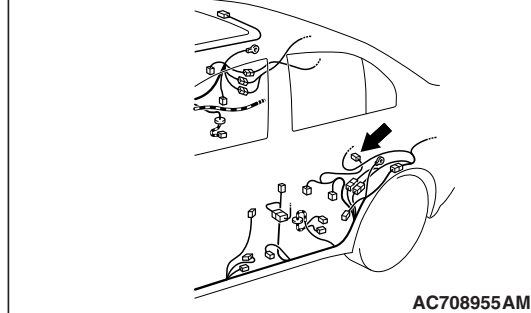

TROUBLESHOOTING HINTS

- Configuration function setting
- Damaged wiring harness and connectors
- Malfunctions of the steering lock push switch
- Malfunction of the keyless operation key
- Malfunction of the receiver antenna assembly
- Malfunction of KOS-ECU

DIAGNOSIS

Required Special Tools:

- MB992006: Extra fine probe
- MB991223: Harness set
- MB991958 Scan Tool (M.U.T.-III Sub Assembly)
 - MB991824: Vehicles Communication Interface (V.C.I.)
 - MB991827 M.U.T.-III USB Cable
 - MB991910 M.U.T.-III Main Harness A

STEP 1. Check the power supply circuit and the ground circuit to KOS-ECU.

Refer to Inspection procedure 3 "Abnormality in KOS-ECU power supply and ground circuits" [P.42B-164](#).

Q: Are the power supply circuit and the ground circuit to KOS-ECU in good condition?

YES : Go to Step 2.

NO : Repair the power supply circuit and the ground circuit to KOS-ECU.

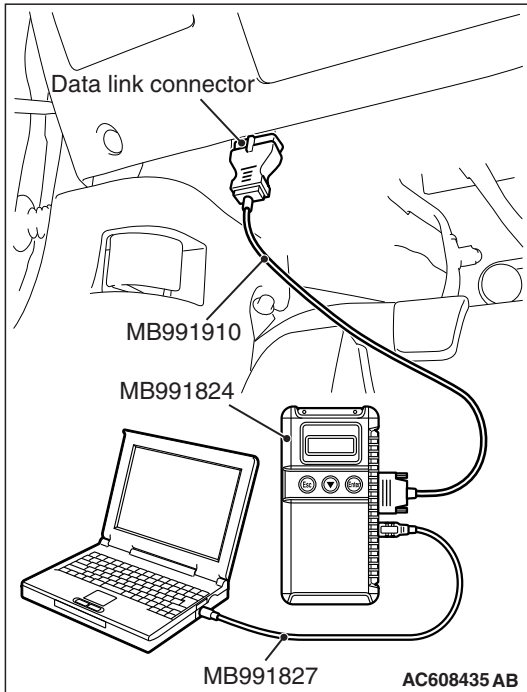

STEP 2. Using scan tool MB991958, diagnose the CAN bus line.

⚠ CAUTION

To prevent damage to scan tool MB991958, always turn the ignition switch to the "LOCK" (OFF) position before connecting or disconnecting scan tool MB991958.

- (1) Connect scan tool MB991958. Refer to "How to connect the Scan Tool (M.U.T.-III) P.42B-9."
- (2) Turn the ignition switch to the "ON" position.
- (3) Diagnose the CAN bus line.
- (4) Turn the ignition switch to the "LOCK" (OFF) position.

Q: Is the CAN bus line found to be normal?

YES : Go to Step 3.

NO : Repair the CAN bus line. (Refer to GROUP 54C, Diagnosis P.54C-15).

STEP 3. Using scan tool MB991958, read the KOS-ECU diagnostic trouble code.

Check if DTC is set to the KOS-ECU.

Q: Is the DTC set?

YES : Troubleshoot the KOS. (Refer to P.42B-23).

NO : Go to Step 4.

STEP 4. Using scan tool MB991958, Check the configuration function.

Use the ETACS-ECU configuration function to check that the "KOS feature" is set to "Both enable" or "ENG strt enable".

Q: Is it set to "Both enable" or "ENG strt enable"?

YES : Go to Step 5.

NO : Use the ETACS-ECU configuration function to set the "KOS feature" to "Both enable" or "ENG strt enable". (Refer to P.42B-238).

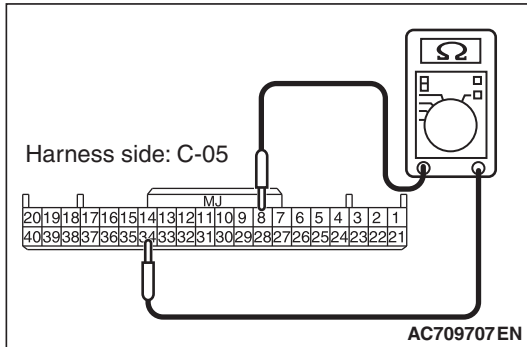

STEP 5. Check the ignition push switch. Measure the resistance at KOS-ECU connector C-05.

- (1) Disconnect the KOS-ECU connector C-05.
- (2) With the IG knob push switch pressed, measure the resistance at the harness-side connector.
- (3) Resistance between the KOS-ECU connector C-05 terminal No.8 and 34.

OK: The resistance should be 2 Ω or less.

Q: Is the measured resistance 2 Ω or less?

YES : Go to Step 6.

NO : Check the KOS-ECU C-05 connector, the key reminder switch connector C-211, the ETACS-ECU connector C-315, and the wiring harness between the KOS-ECU connector C-05 (terminal No.8, 34) and the C-211 key reminder switch connector (terminal No.10, 4), and between the key reminder switch connector C-211 (terminal No.1) and the ETACS-ECU connector C-315 (terminal No.10), and repair them if necessary. If they are normal, replace the key reminder switch.

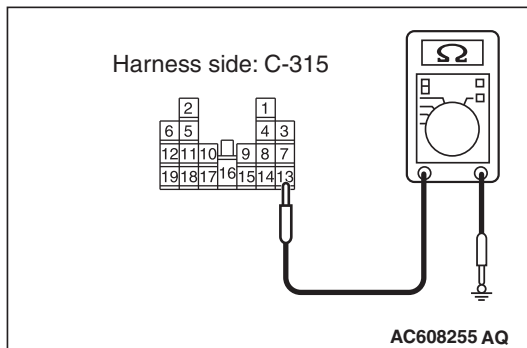

STEP 6. Check the key reminder switch. Measure the resistance at ETACS-ECU connector C-315.

- (1) Disconnect the ETACS-ECU connector C-315.
- (2) Measure the resistance at the harness-side connector with the ignition key removed from the ignition key cylinder.
- (3) Resistance between the ETACS-ECU connector C-315 terminal No.13 and the ground.

OK: The resistance should be 2 Ω or less.

Q: Is the measured resistance 2 Ω or less?

YES : Go to Step 7.

NO : Check the key reminder switch connector C-211, the ETACS-ECU connector C-315, the wiring harness between the key reminder switch connector C-211 (terminal No. 3) and the ETACS-ECU connector C-315 (terminal No. 13), and between the key reminder switch connector C-211 (terminal No. 2) and the ground. If they are normal, replace the key reminder switch.

STEP 7. Check with another registered keyless operation key.

Q: Does the IG knob turn? (Is the keyless operation key recognized?)

YES : Replace the keyless operation key with which the IG knob does not turn (no recognition) and register the ID codes. (Refer to [P.42B-11.](#))

NO : Go to Step 8.

STEP 8. Check receiver antenna assembly connector D-14, KOS-ECU connector C-05, joint connector (6) C-16 and intermittent connector C-41 for loose, corroded or damaged terminals, or terminals pushed back in the connector.

Q: Is the receiver antenna assembly connector D-14, KOS-ECU connector C-05, joint connector (6) C-16 and intermittent connector C-41 in good condition?

YES : Go to Step 9.

NO : Repair the defective connector.

STEP 9. Check the wiring harness between the receiver antenna assembly connector D-14 (terminal Nos.1, 8, 12, 3, 5) and the KOS-ECU connector C-05 (terminal Nos.12, 32, 7, 9, 13) for open circuit.

- (1) Disconnect receiver antenna assembly connector D-14 and KOS-ECU connector C-05, and check the wiring harness.
- (2) Check the wiring harness between receiver antenna assembly connector D-14 (terminal No.1) and KOS-ECU connector C-05 (terminal No.12)

OK: Continuity exists (2 Ω or less)

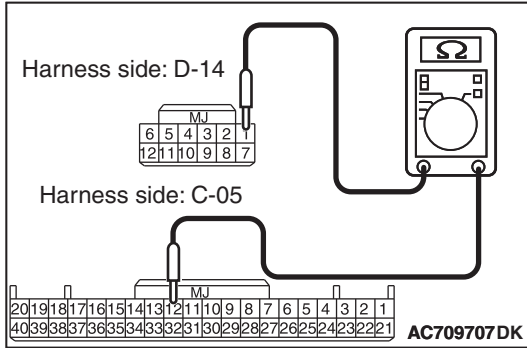

- (3) Check the wiring harness between receiver antenna assembly connector D-14 (terminal No.8) and KOS-ECU connector C-05 (terminal No.32)

OK: Continuity exists (2 Ω or less)

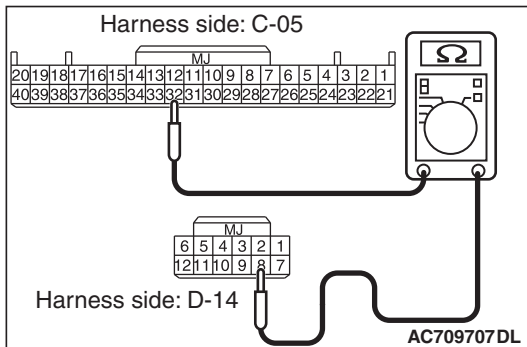

- (4) Check the wiring harness between receiver antenna assembly connector D-14 (terminal No.12) and KOS-ECU connector C-05 (terminal No.7)

OK: Continuity exists (2 Ω or less)

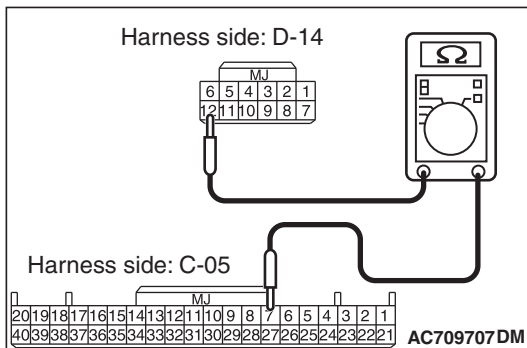

- (5) Check the wiring harness between receiver antenna assembly connector D-14 (terminal No.3) and KOS-ECU connector C-05 (terminal No.9)

OK: Continuity exists (2 Ω or less)

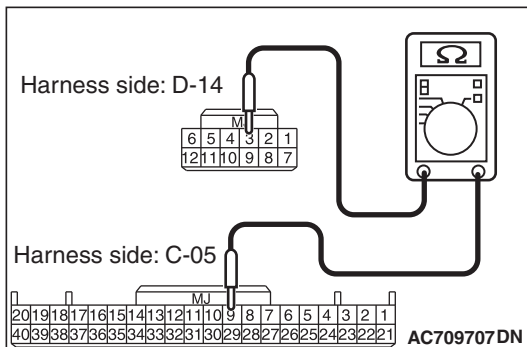

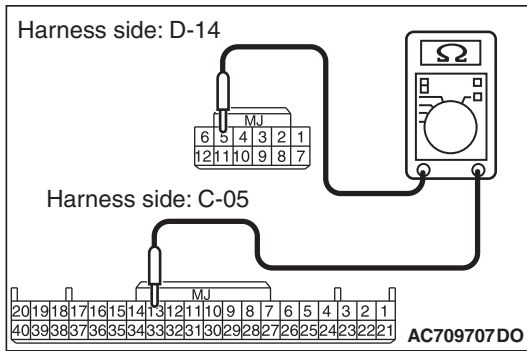

- (6) Check the wiring harness between receiver antenna assembly connector D-14 (terminal No.5) and KOS-ECU connector C-05 (terminal No.13)

OK: Continuity exists (2 Ω or less)

- Q: Is the wiring harness between receiver antenna assembly connector D-14 (terminal Nos.1, 8, 12, 3, 5) and the KOS-ECU connector C-05 (terminal Nos.12, 32, 7, 9, 13) in good condition?**

YES : Go to Step 10.

NO (receiver antenna assembly connector D-14 terminal No.1 –KOS-ECU connector C-05 terminal No.12.) :

Repair the wiring harness between receiver antenna assembly connector D-14 (terminal No.1) and the KOS-ECU connector C-05 (terminal No.12).

NO (receiver antenna assembly connector D-14 terminal No.8 –KOS-ECU connector C-05 terminal No.32.) :

Repair the wiring harness between receiver antenna assembly connector D-14 (terminal No.8) and the KOS-ECU connector C-05 (terminal No.32).

NO (receiver antenna assembly connector D-14 terminal No.12 –KOS-ECU connector C-05 terminal No.7.) :

Repair the wiring harness between receiver antenna assembly connector D-14 (terminal No.12) and the KOS-ECU connector C-05 (terminal No.7).

NO (receiver antenna assembly connector D-14 terminal No.3 –KOS-ECU connector C-05 terminal No.9.) :

Repair the wiring harness between receiver antenna assembly connector D-14 (terminal No.3) and the KOS-ECU connector C-05 (terminal No.9).

NO (receiver antenna assembly connector D-14 terminal No.5 –KOS-ECU connector C-05 terminal No.13.) :

Repair the wiring harness between receiver antenna assembly connector D-14 (terminal No.5) and the KOS-ECU connector C-05 (terminal No.13).

STEP 10. Check the wiring harness between the receiver antenna assembly connector D-14 (terminal Nos.1, 8, 12, 3, 5) and the ground for short circuit.

(1) Disconnect receiver antenna assembly connector D-14, and check the wiring harness.

(2) Check the wiring harness between receiver antenna assembly connector D-14 (terminal No.1) and ground

OK: No continuity

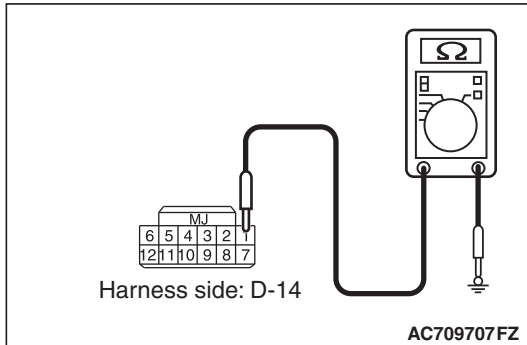

(3) Check the wiring harness between receiver antenna assembly connector D-14 (terminal No.8) and ground

OK: No continuity

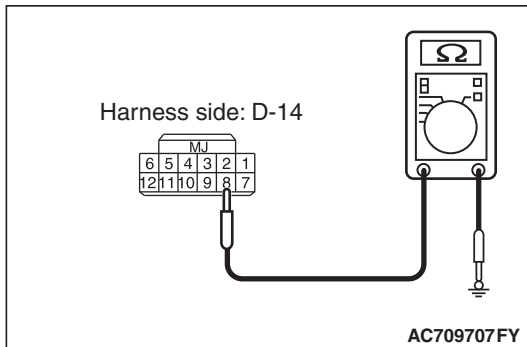

(4) Check the wiring harness between receiver antenna assembly connector D-14 (terminal No.12) and ground

OK: No continuity

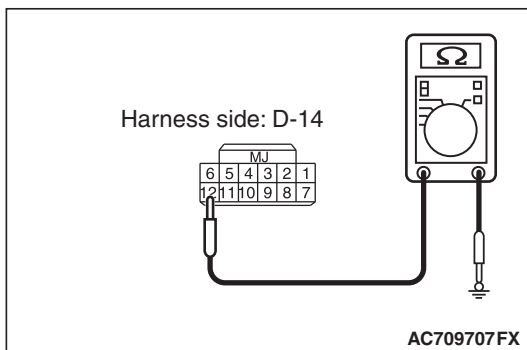

(5) Check the wiring harness between receiver antenna assembly connector D-14 (terminal No.3) and ground

OK: No continuity

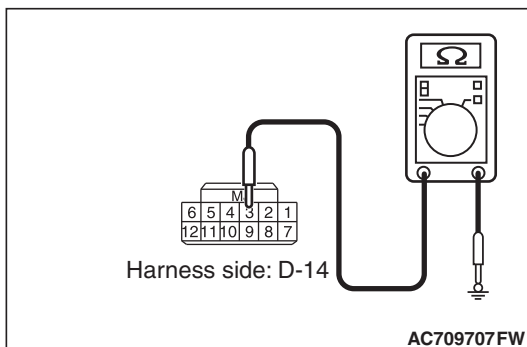

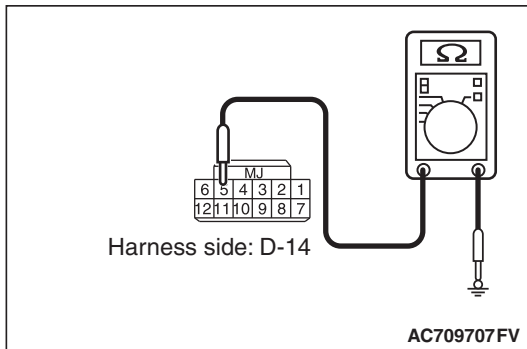

- (6) Check the wiring harness between receiver antenna assembly connector D-14 (terminal No.5) and ground

OK: No continuity

Q: Is the wiring harness between receiver antenna assembly connector D-14 (terminal Nos.1, 8, 12, 3, 5) and the ground in good condition?

YES : Go to Step 11.

NO (receiver antenna assembly connector D-14 terminal No.1 –ground.) : Repair the wiring harness between receiver antenna assembly connector D-14 (terminal No.1) and the KOS-ECU connector C-05 (terminal No.12).

NO (receiver antenna assembly connector D-14 terminal No.8 –ground.) : Repair the wiring harness between receiver antenna assembly connector D-14 (terminal No.8) and the ground.

NO (receiver antenna assembly connector D-14 terminal No.12 –ground.) : Repair the wiring harness between receiver antenna assembly connector D-14 (terminal No.12) and the ground.

NO (receiver antenna assembly connector D-14 terminal No.3 –ground.) : Repair the wiring harness between receiver antenna assembly connector D-14 (terminal No.3) and the ground.

NO (receiver antenna assembly connector D-14 terminal No.5 –ground.) : Repair the wiring harness between receiver antenna assembly connector D-14 (terminal No.5) and the ground.

STEP 11. Check the power supply circuit to the receiver antenna assembly. Measure the voltage at receiver antenna assembly connector D-14.

- (1) Disconnect receiver antenna assembly connector D-14 and measure the voltage available at the harness side of the connector.
- (2) Measure the voltage between terminal No. 12 and ground.
 - The voltage should measure 5 volt.

Q: Is the measured voltage 5 volt?

YES : Go to Step 12.

NO : Replace KOS-ECU and register the ID codes. (Refer to [P.42B-11.](#))

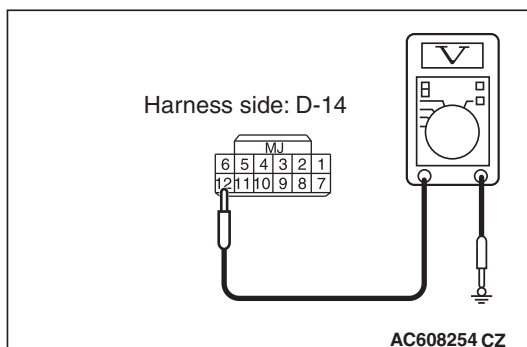

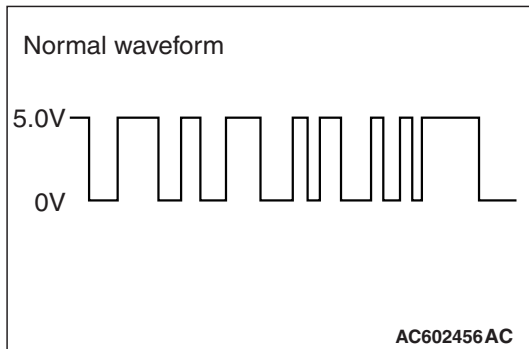

STEP 12. Using the oscilloscope, check the waveform at receiver antenna module connector D-14 and ground by backprobing.

- (1) Do not disconnect the receiver antenna assembly connector D-14.
- (2) Connect an oscilloscope to receiver antenna assembly connector D-14 terminal No. 12 and ground by backprobing.
- (3) Turn the ignition switch to the "LOCK" (OFF) position.
 - Check the waveform.

Q: Is the waveform normal?

YES : Go to Step 13.

NO : Replace the receiver antenna assembly.

STEP 13. Check of the troubles.

Check that the IG turns (keyless operation is recognized).

Q: Does the IG knob turn (keyless operation is not recognized) in good condition?

YES : The procedure is complete.

NO : Replace KOS-ECU and register the ID codes. (Refer to [P.42B-11.](#))

Inspection Procedure 6: The engine will not start with KOS (IG knob operates normally).

CAUTION

Before replacing the ECU, ensure that the communication circuit is normal.

TROUBLESHOOTING HINTS

- The CAN bus line is defective.

- Malfunction of the MFI system
- Function setting error or no setting with customization
- VIN not written or unmatched

DIAGNOSIS

Required Special Tools:

- MB991958: Scan Tool (M.U.T.-III Sub Assembly)
 - MB991824: Vehicles Communication Interface (V.C.I.)
 - MB991827: M.U.T.-III USB Cable
 - MB991910: M.U.T.-III Main Harness A

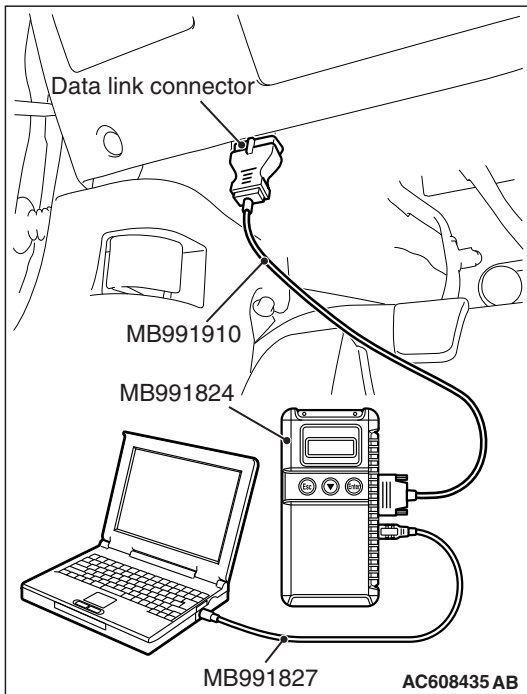

STEP 1. Using scan tool MB991958, diagnose the CAN bus line

⚠ CAUTION

To prevent damage to scan tool MB991958, always turn the ignition switch to the "LOCK" (OFF) position before connecting or disconnecting scan tool MB991958.

- (1) Connect scan tool MB991958. Refer to "How to connect the Scan Tool (M.U.T.-III) P.42B-9."
- (2) Turn the ignition switch to the "ON" position.
- (3) Diagnose the CAN bus line.
- (4) Turn the ignition switch to the "LOCK" (OFF) position.

Q: Is the CAN bus line found to be normal?

YES : Go to Step 2.

NO : Repair the CAN bus line. (Refer to GROUP 54C, Diagnosis P.54C-15).

STEP 2. Using scan tool MB991958, read the KOS-ECU diagnostic trouble code.

Check if DTC is set to the KOS-ECU.

Q: Is the DTC set?

YES : Troubleshoot the KOS. (Refer to P.42B-23).

NO : Go to Step 3.

STEP 3. Using scan tool MB991958, Check the customization function.

Use the ETACS-ECU customization function to check that the "KOS feature" is set to "Both enable" or "ENG strt enable".

- (1) Turn the ignition switch to the "ON" position.
- (2) Use the ETACS-ECU configuration function to check that the "KOS feature" is set to "Both enable" or "ENG strt enable".
- (3) Turn the ignition switch to the "LOCK" (OFF) position.

Q: Is it set to "Both enable" or "ENG strt enable"?

YES : Go to Step 4.

NO : Use the ETACS-ECU configuration function to set the "KOS feature" to "Both enable" or "ENG strt enable" (Refer to P.42B-238).

STEP 4. Check that the engine starts.

Q: Does the engine start?

YES : The procedure is complete.

NO : Refer to GROUP 13A –Troubleshooting P.13A-48.

Inspection Procedure 7: Engine does not start with emergency key (cranking but no initial combustion).

TECHNICAL DESCRIPTION (COMMENT)

If the fuel injection does not work, KOS-ECU and the MFI system may have a problem. This symptom is not considered abnormal when the engine is started by an keyless operation key that has not been registered.

TROUBLESHOOTING HINTS

- Malfunction of the MFI system
- Malfunction of KOS-ECU
- Malfunction of CAN bus line
- Malfunction of the transponder
- VIN not programmed

DIAGNOSIS

Required Special Tools:

- MB991958: Scan Tool (M.U.T.-III Sub Assembly)
 - MB991824: Vehicle Communication Interface (V.C.I.)
 - MB991827: M.U.T.-III USB Cable
 - MB991910: M.U.T.-III Main Harness A (Vehicles with CAN communication system)

STEP 1. Check the battery voltage.

Measure the battery voltage when cranking.

- The voltage should measure 8 volt or more.

Q: Is the measured voltage 8 volt or more?

YES : Go to Step 2.

NO : Check the battery (Refer to GROUP 54A –Battery test [P.54A-9](#)).

STEP 2. Using scan tool MB991958, diagnose the CAN bus line.

CAUTION

To prevent damage to scan tool MB991958, always turn the ignition switch to the "LOCK" (OFF) position before connecting or disconnecting scan tool MB991958.

- (1) Connect scan tool MB991958. Refer to "How to connect the Scan Tool (M.U.T.-III) [P.42C-6](#)."
- (2) Turn the ignition switch to the "ON" position.
- (3) Diagnose the CAN bus line.
- (4) Turn the ignition switch to the "LOCK" (OFF) position.

Q: Is the CAN bus line found to be normal?

YES : Go to Step 3.

NO : Repair the CAN bus line (Refer to GROUP 54C, Diagnosis [P.54C-15](#)).

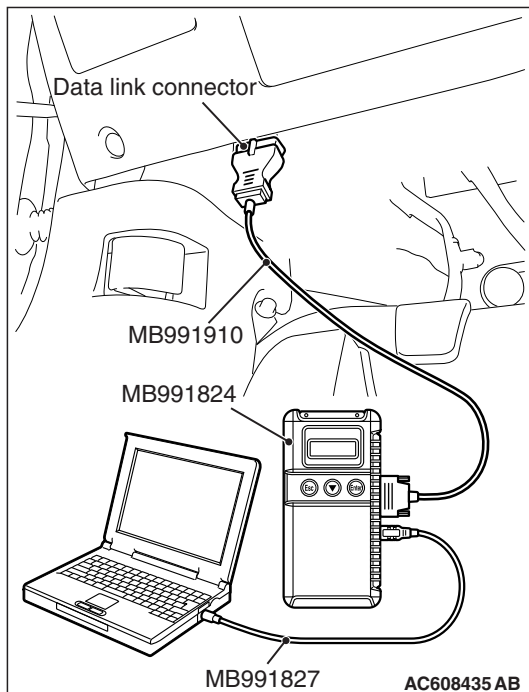

STEP 3. Using scan tool MB991958, read the MFI system diagnostic trouble code.

Check if DTC is set to the engine control module.

Q: Is the DTC set?

YES : Troubleshoot the MFI system (Refer to GROUP 13A, Diagnosis [P.13A-48](#)).

NO : Go to Step 4.

STEP 4. Using scan tool MB991958, read the KOS-ECU diagnostic trouble code.

Check if DTC is set to the KOS.

Q: Is the DTC set?

YES : Refer to [P.42B-23](#).

NO : Go to Step 5.

STEP 5. Check that the engine starts.

Q: Does the engine start?

YES : The procedure is complete.

NO : Refer to GROUP 13A , Diagnosis [P.13A-48](#). When the cause of the failure cannot be tracked down by the troubleshooting in GROUP 13A, replace KOS-ECU and register the ID codes (Refer to [P.42B-227](#)).

Inspection Procedure 8: No door will be locked or unlocked by operating a lock switch on any door, or by touching the unlock sensor.

CAUTION

Before replacing the ECU, ensure that the power supply circuit, the ground circuit and the communication circuit are normal.

ETACS-ECU and Key Reminder Switch Circuit

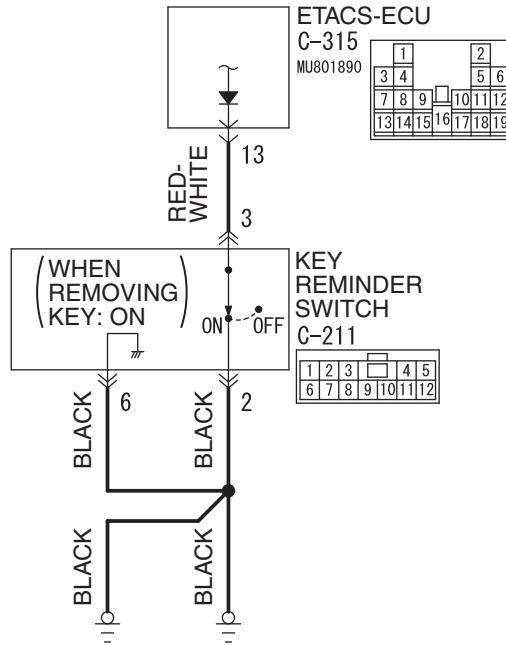

AC609048AC

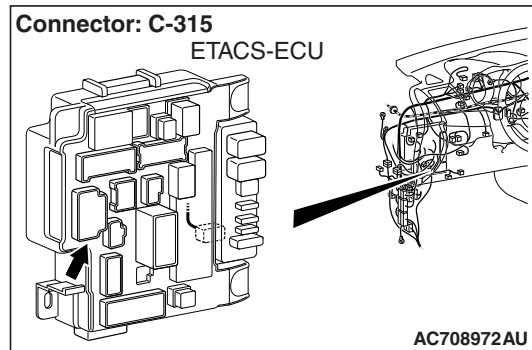
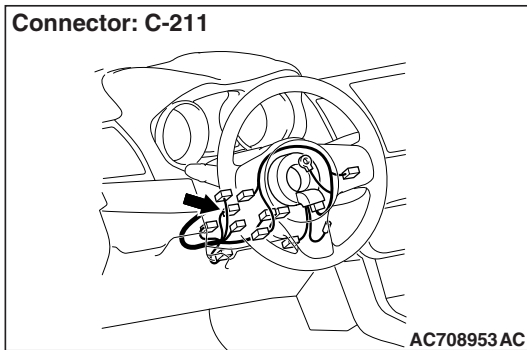

TROUBLESHOOTING HINTS

- Malfunction of the CAN bus lines
- Malfunction of the central door locking system
- Malfunction of the keyless operation key
- Malfunction of the key reminder switch
- Damaged wiring harness and connectors
- Malfunction of the KOS-ECU
- Function setting error or no setting with a customization

DIAGNOSIS

Required Special Tools:

- MB992006: Extra fine probe
- MB991223: Harness set
- MB991958: Scan Tool (M.U.T.-III Sub Assembly)
 - MB991824: Vehicles Communication Interface (V.C.I.)
 - MB991827: M.U.T.-III USB Cable
 - MB991910: M.U.T.-III Main Harness A

STEP 1. Using scan tool MB991958, read CAN bus diagnostic trouble code.

CAUTION

To prevent damage to scan tool MB991958, always turn the ignition switch to the "LOCK" (OFF) position before connecting or disconnecting scan tool MB991958.

- (1) Connect scan tool MB991958. Refer to "How to connect scan tool (M.U.T.-III) [P.42B-9](#)."
- (2) Turn the ignition switch to the "ON" position.
- (3) Check whether the CAN bus lines related DTC is set.
- (4) Turn the ignition switch to the "LOCK" (OFF) position.

Q: Is the DTC set?

YES : Repair the CAN bus line (Refer to GROUP 54C, CAN bus diagnostics table [P.54C-15](#)).

NO : Go to Step 2.

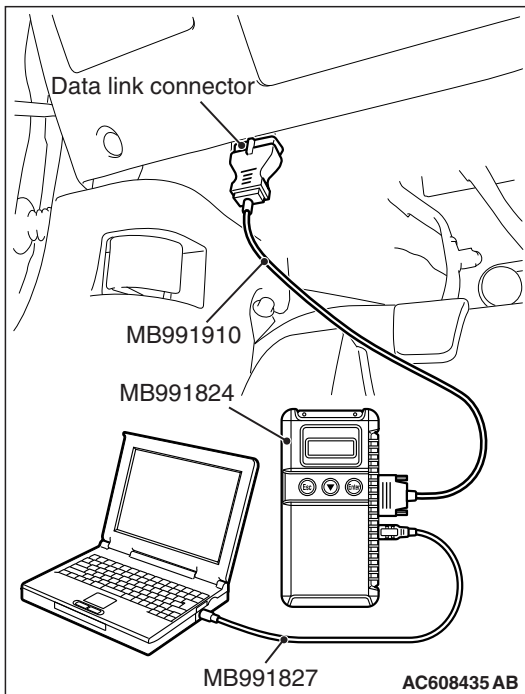

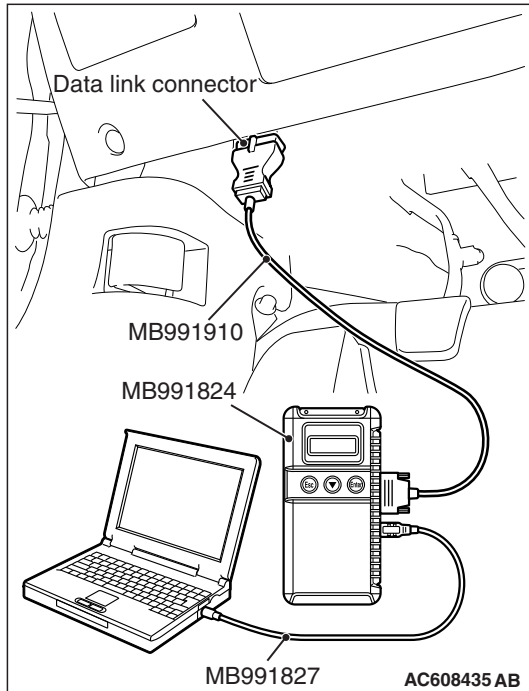

STEP 2. Using scan tool MB991958, read the diagnostic trouble code.

⚠ CAUTION

To prevent damage to scan tool MB991958, always turn the ignition switch to the "LOCK" (OFF) position before connecting or disconnecting scan tool MB991958.

- (1) Connect scan tool MB991958. Refer to "How to connect scan tool (M.U.T.-III) P.42B-9."
- (2) Turn the ignition switch to the "ON" position.
- (3) Check whether the KOS-ECU related DTC is set.
- (4) Turn the ignition switch to the "LOCK" (OFF) position.

Q: Is the DTC set?

- YES** : Diagnose the KOS-ECU. Refer to P.42B-23.
NO : Go to Step 3.

STEP 3. Check the central door locking operation

Check that the central door locking system works normally.

Q: Is the check result normal?

- YES** : Go to Step 4.
NO : Perform troubleshooting for the central door locking system (Refer to GROUP 42A, Door – Troubleshooting P.42A-30).

STEP 4. Check the customize function.

Check that either of the followings other than "ENG strt enable" or "Both disabled" are set for "KOS feature" with the customization function.

- Both enable
- Door Entry enable

Q: Is the check result normal?

- YES** : Go to Step 5.
NO : Set either of the followings other than "ENG strt enable" or "Both disabled" for "KOS feature" with the customization function (Refer to P.42B-238).

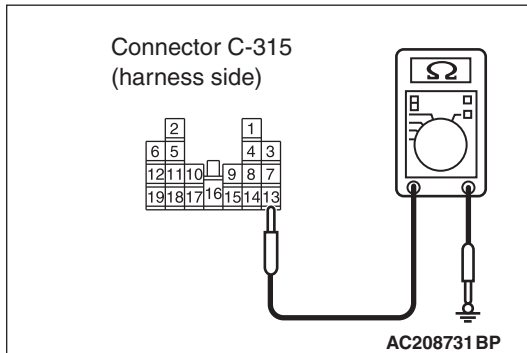

STEP 5. Key reminder switch check

- (1) Disconnect the C-315 ETACS-ECU connector.
- (2) Measure the resistance at the harness-side connector with the ignition key removed from the ignition key cylinder.
- (3) Check the continuity between the C-315 ETACS-ECU connector terminal No. 13 and the ground.

OK: Continuity exists (2 Ω or less)

Q: Is the check result normal?

YES : Go to Step 6.

NO : Check the C-211 key reminder switch connector, the C-315 ETACS-ECU connector, the wiring harness between the C-211 key reminder switch connector (terminal No. 3) and the C-315 ETACS-ECU connector (terminal No. 13), and between the C-211 key reminder switch connector (terminal No. 2) and the ground. If they are normal, replace the key reminder switch.

STEP 6. Check with another registered keyless operation key.

Q: Does the IG knob turn? (Is the keyless operation key recognized?)

YES : Replace the keyless operation key with which the IG knob does not turn (no recognition) and register the ID codes (Refer to [P.42B-11](#)).

NO : Go to Step 7.

STEP 7. Check of the troubles

Operate the lock switch and check that the door can be locked and unlocked. Also, check that the unlock sensor can lock and unlock the door.

Q: Is the check result normal?

YES : The diagnosis is complete.

NO : Replace KOS-ECU and register the ID codes (Refer to [P.42B-11](#)).

Inspection Procedure 9: Driver's door lock switch does not work.

CAUTION

Before replacing the ECU, ensure that the power supply circuit, the ground circuit and the communication circuit are normal.

Lock Switch (Front Door: LH) Circuit

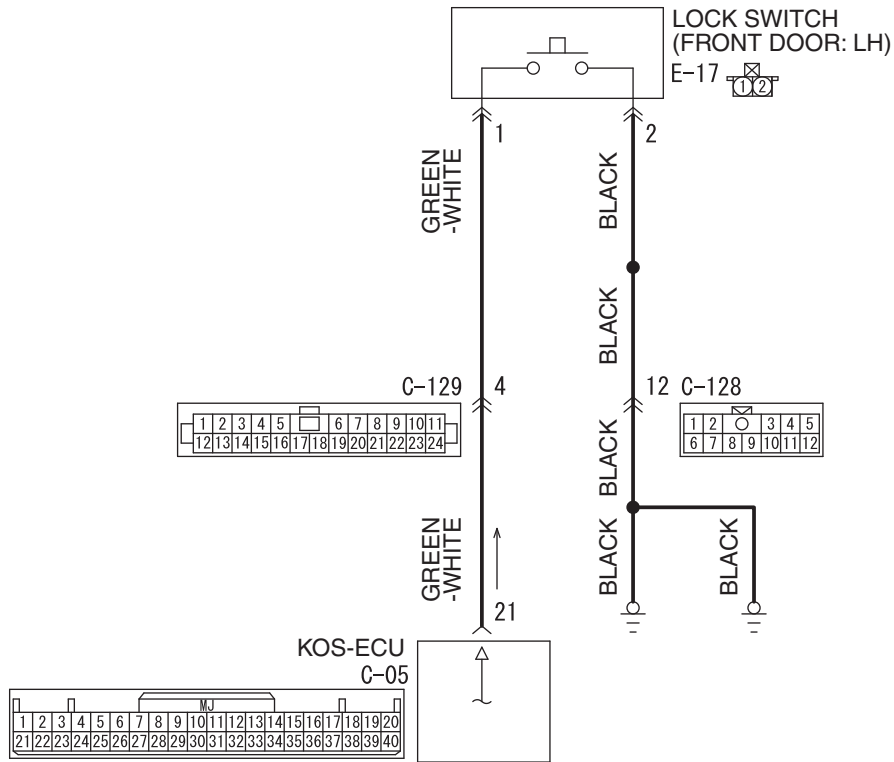

AC709307AC

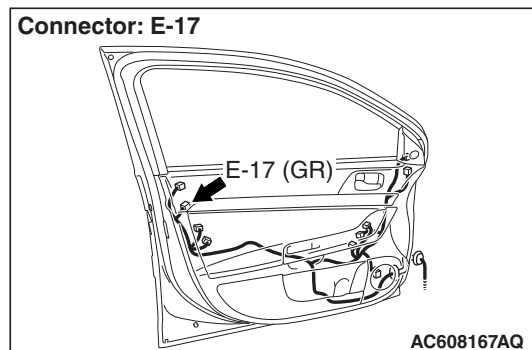
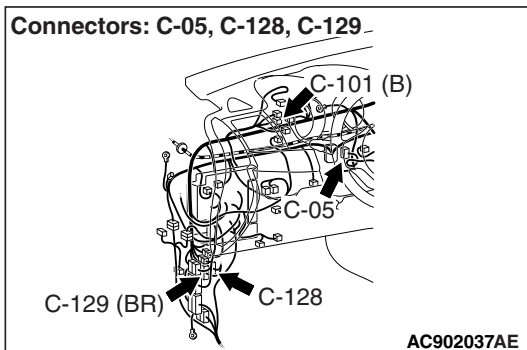

TROUBLESHOOTING HINTS

- Malfunction of the exterior transmitter antenna assembly (driver's side)
- Malfunction of the lock switch (front door: LH)
- Damaged wiring harness and connectors
- Malfunction of the KOS-ECU

DIAGNOSIS

Required Special Tools:

- MB992006: Extra fine probe
- MB991223: Harness set
- MB991958: Scan Tool (M.U.T.-III Sub Assembly)
 - MB991824: Vehicles Communication Interface (V.C.I.)
 - MB991827: M.U.T.-III USB Cable
 - MB991910: M.U.T.-III Main Harness A

STEP 1. Using scan tool MB991958, read the diagnostic trouble code.

⚠ CAUTION

To prevent damage to scan tool MB991958, always turn the ignition switch to the "LOCK" (OFF) position before connecting or disconnecting scan tool MB991958.

- (1) Connect scan tool MB991958. Refer to "How to connect scan tool (M.U.T.-III) [P.42B-9](#)."
- (2) Turn the ignition switch to the "ON" position.
- (3) Check whether the KOS-ECU related DTC is set.
- (4) Turn the ignition switch to the "LOCK" (OFF) position.

Q: Is the DTC set?

YES : Diagnose the KOS-ECU. Refer to [P.42B-23](#).

NO : Go to Step 2.

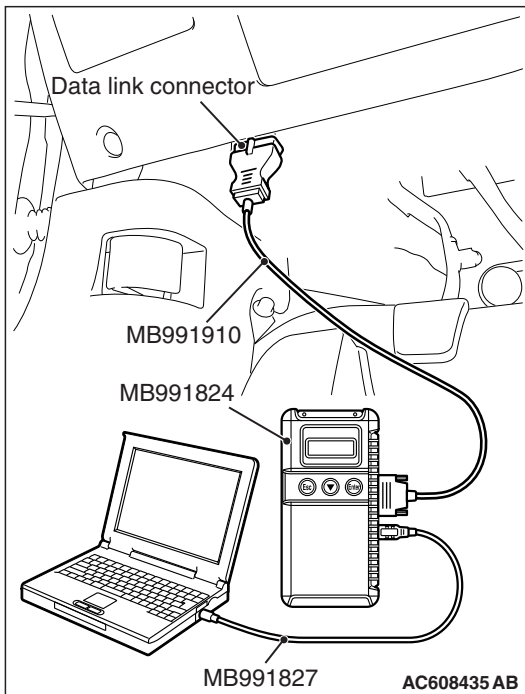

STEP 2. Check KOS-ECU connector C-05 and lock switch (front door: LH) connector E-17 for loose, corroded or damaged terminals, or terminals pushed back in the connector.

Q: Are KOS-ECU connector C-05 and lock switch (front door: LH) connector E-17 in good condition?

YES : Go to Step 3.

NO : Repair or replace the damaged component(s). Refer to GROUP 00E, Harness Connector Inspection [P.00E-2](#). Check that the driver's door lock switch works normally.

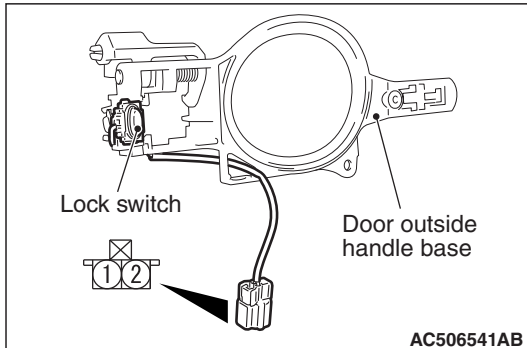
**STEP 3. Check the lock switch (front door: LH).**

- (1) Remove the door outside handle base. Refer to GROUP 42A, Door Handle and Latch P.42A-136.
- (2) Check continuity when the lock switch (front door: LH) is operated to "ON" or "OFF" position.

Switch position	Terminal number	Specified condition
ON	1 -2	Continuity exists (2 Ω or less)
OFF	1 -2	Open circuit

Q: Is the lock switch (front door: LH) normal?

YES : Go to Step 4.

NO : Replace the door outside handle base (front door: LH).

STEP 4. Check the wiring harness between KOS-ECU connector C-05 (terminal No. 21) and lock switch (front door: LH) connector E-17 (terminal No. 1), and between lock switch (front door: LH) connector E-17 (terminal No. 2) and ground.

- Check the signal and ground wires for open circuit.

NOTE: Also check intermediate connectors C-128, C-129 for loose, corroded, or damaged terminals, or terminals pushed back in the connector. If intermediate connectors C-128, C-129 is damaged, repair or replace the damaged component(s) as described in GROUP 00E, Harness Connector Inspection P.00E-2.

Q: Are the wiring harness between KOS-ECU connector C-05 (terminal No. 21) and lock switch (front door: LH) connector E-17 (terminal No. 1), and between lock switch (front door: LH) connector E-17 (terminal No. 2) and ground in good condition?

YES : Go to Step 5.

NO : The wiring harness may be damaged or the connector(s) may have loose, corroded or damaged terminals, or terminals pushed back in the connector. Repair the wiring harness as necessary. Check that the driver's door lock switch works normally.

STEP 5. KOS communication test

Using scan tool (M.U.T-III), perform the antenna communication test to check that the exterior transmitter antenna (driver's side) communicates normally (Refer to P.42B-227).

Q: Is the check result normal?

YES : Go to Step 6.

NO : Perform troubleshooting for the diagnostic trouble code No. B240A (Refer to P.42B-72).

STEP 6. Check of the troubles

Operate the lock switch (front door: LH) and check that the door can be locked.

Q: Is the check result normal?

YES : The diagnosis is complete.

NO : Replace KOS-ECU and register the ID codes (Refer to P.42B-11).

Inspection Procedure 10: Driver's door unlock sensor does not work.

CAUTION

Before replacing the ECU, ensure that the power supply circuit, the ground circuit and the communication circuit are normal.

Unlock Sensor (Front Door: LH) Circuit

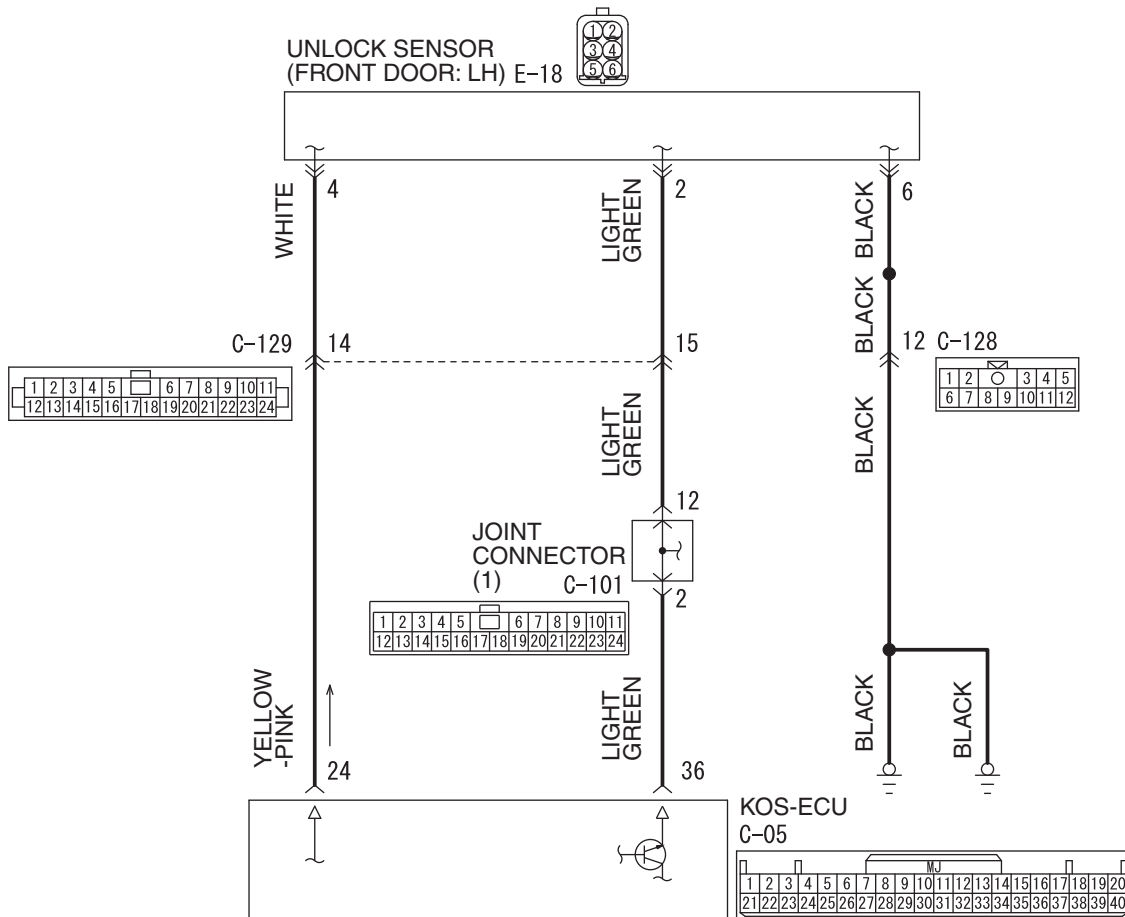

AC709308AD

Connectors: C-05, C-101, C-128, C-129

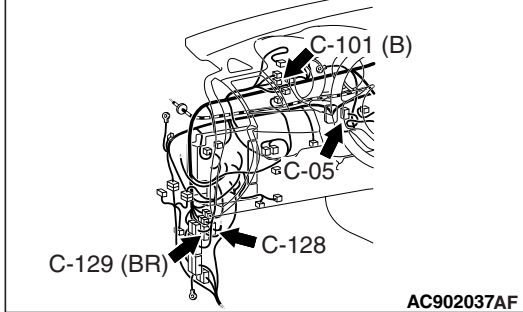

Connector: E-18

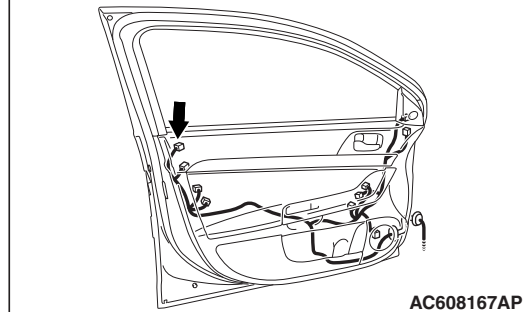

TROUBLESHOOTING HINTS

- Malfunction of the exterior transmitter antenna assembly (driver's side)
- Malfunction of the unlock sensor (front door: LH)
- Damaged wiring harness and connectors
- Malfunction of the KOS-ECU

DIAGNOSIS

Required Special Tools:

- MB992006: Extra fine probe
- MB991223: Harness set
- MB991958: Scan Tool (M.U.T.-III Sub Assembly)
 - MB991824: Vehicles Communication Interface (V.C.I.)
 - MB991827: M.U.T.-III USB Cable
 - MB991910: M.U.T.-III Main Harness A

STEP 1. Using scan tool MB991958, read the diagnostic trouble code.

⚠ CAUTION

To prevent damage to scan tool MB991958, always turn the ignition switch to the "LOCK" (OFF) position before connecting or disconnecting scan tool MB991958.

- (1) Connect scan tool MB991958. Refer to "How to connect scan tool (M.U.T.-III) [P.42B-9](#)."
- (2) Turn the ignition switch to the "ON" position.
- (3) Check whether the KOS-ECU related DTC is set.
- (4) Turn the ignition switch to the "LOCK" (OFF) position.

Q: Is the DTC set?

YES : Diagnose the KOS-ECU. Refer to [P.42B-23](#).

NO : Go to Step 2.

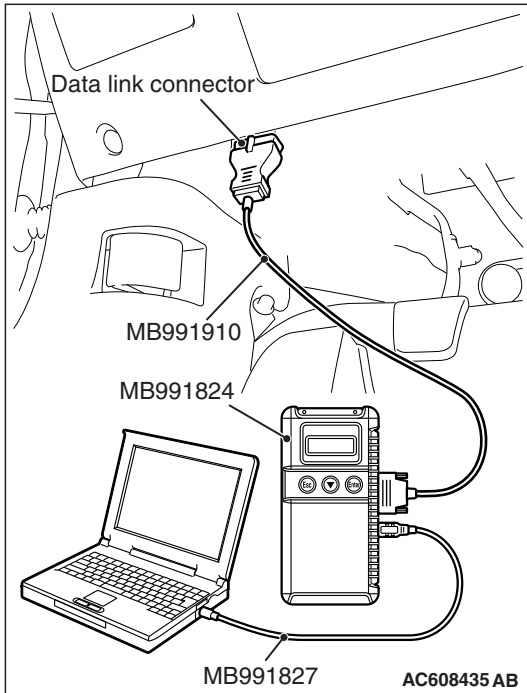

STEP 2. Check KOS-ECU connector C-05 and unlock sensor (front door: LH) connector E-18 for loose, corroded or damaged terminals, or terminals pushed back in the connector.

Q: Are KOS-ECU connector C-05 and unlock sensor (front door: LH) connector E-18 in good condition?

YES : Go to Step 3.

NO : Repair or replace the damaged component(s). Refer to GROUP 00E, Harness Connector Inspection [P.00E-2](#). Check that the driver's door unlock sensor works normally.

STEP 3. Check the wiring harness between KOS-ECU connector C-05 (terminal Nos. 24 and 36) and unlock sensor (front door: LH) connector E-18 (terminal Nos. 4 and 2), and between unlock sensor (front door: LH) connector E-18 (terminal No. 6) and ground.

- Check the signal and ground wires for open circuit.

NOTE: Also check joint connector (1) C-101, intermediate connectors C-128, C-129 for loose, corroded, or damaged terminals, or terminals pushed back in the connector. If joint connector (1) C-101, intermediate connectors C-128, C-129 is damaged, repair or replace the damaged component(s) as described in GROUP 00E, Harness Connector Inspection P.00E-2.

Q: Are the wiring harness between KOS-ECU connector C-05 (terminal Nos. 24 and 36) and unlock sensor (front door: LH) connector E-18 (terminal Nos. 4 and 2), and between unlock sensor (front door: LH) connector E-18 (terminal No. 6) and ground in good condition?

YES : Go to Step 4.

NO : The wiring harness may be damaged or the connector(s) may have loose, corroded or damaged terminals, or terminals pushed back in the connector. Repair the wiring harness as necessary. Check that the driver's door unlock sensor works normally.

STEP 4. KOS communication test

Using scan tool (M.U.T-III), perform the antenna communication test to check that the exterior transmitter antenna (driver's side) communicates normally (Refer to [P.42B-227](#)).

Q: Is the check result normal?

YES : Go to Step 5.

NO : Perform troubleshooting for the diagnostic trouble code No. B240A (Refer to [P.42B-72](#)).

STEP 5. Check of the troubles

Operate the unlock sensor (front door: LH) and check that the door can be locked.

Q: Is the check result normal?

YES : The diagnosis is complete.

NO : Replace KOS-ECU and register the ID codes (Refer to [P.42B-11](#)).

Inspection Procedure 11: Front passenger's door lock switch does not work.

CAUTION

Before replacing the ECU, ensure that the power supply circuit, the ground circuit and the communication circuit are normal.

Lock Switch (Front Door: RH) Circuit

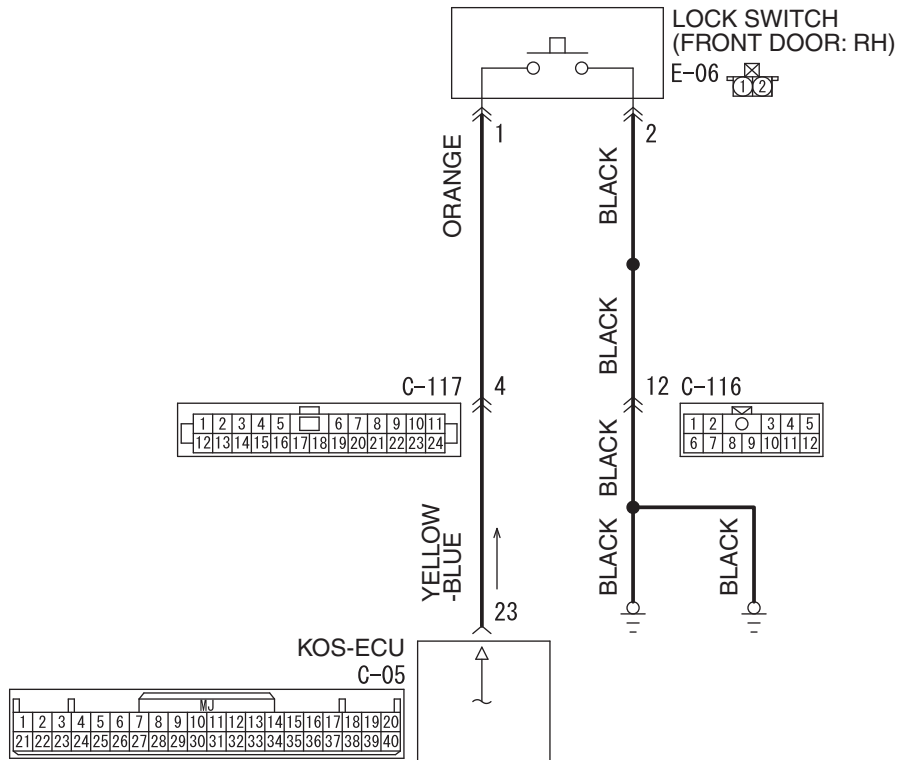

AC709309AC

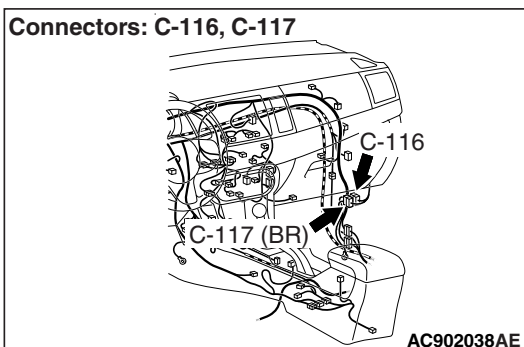
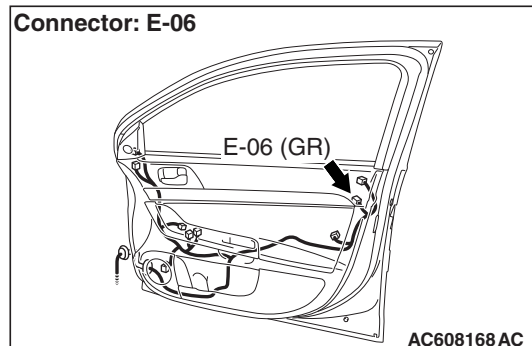
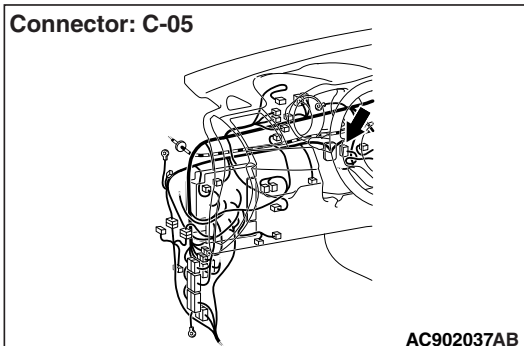

TROUBLESHOOTING HINTS

- Malfunction of the exterior transmitter antenna assembly (front passenger's side)
- Malfunction of the lock switch (front door: RH)
- Damaged wiring harness and connectors
- Malfunction of the KOS-ECU

DIAGNOSIS**Required Special Tools:**

- MB992006: Extra fine probe
- MB991223: Harness set
- MB991958: Scan Tool (M.U.T.-III Sub Assembly)
 - MB991824: Vehicles Communication Interface (V.C.I.)
 - MB991827: M.U.T.-III USB Cable
 - MB991910: M.U.T.-III Main Harness A

STEP 1. Using scan tool MB991958, read the diagnostic trouble code.**⚠ CAUTION**

To prevent damage to scan tool MB991958, always turn the ignition switch to the "LOCK" (OFF) position before connecting or disconnecting scan tool MB991958.

- (1) Connect scan tool MB991958. Refer to "How to connect scan tool (M.U.T.-III) P.42B-9."
- (2) Turn the ignition switch to the "ON" position.
- (3) Check whether the KOS-ECU related DTC is set.
- (4) Turn the ignition switch to the "LOCK" (OFF) position.

Q: Is the DTC set?

YES : Diagnose the KOS-ECU. Refer to P.42B-23.

NO : Go to Step 2.

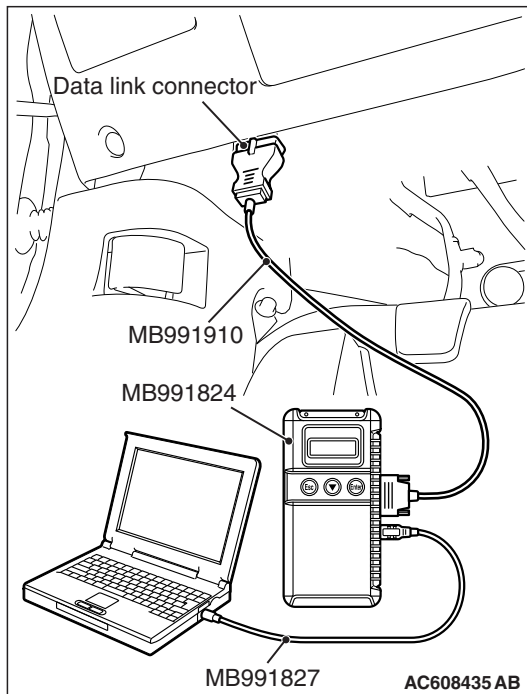
**STEP 2. Check KOS-ECU connector C-05 and lock switch (front door: RH) connector E-06 for loose, corroded or damaged terminals, or terminals pushed back in the connector.****Q: Are KOS-ECU connector C-05 and lock switch (front door: RH) connector E-06 in good condition?**

YES : Go to Step 3.

NO : Repair or replace the damaged component(s). Refer to GROUP 00E, Harness Connector Inspection P.00E-2. Check that the passenger's door lock switch works normally.

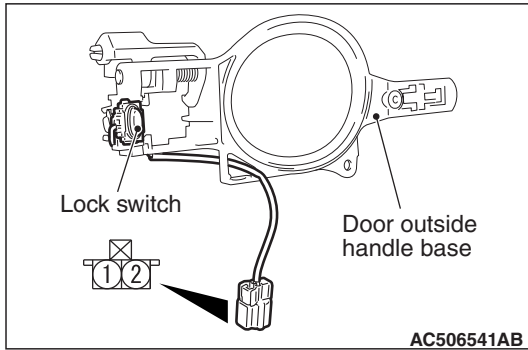

STEP 3. Check the lock switch (front door: RH).

- (1) Remove the door outside handle base. Refer to GROUP 42A, Door Handle and Latch P.42A-136.
- (2) Check continuity when the lock switch (front door: RH) is operated to "ON" or "OFF" position.

Switch position	Terminal number	Specified condition
ON	1 -2	Continuity exists (2 Ω or less)
OFF	1 -2	Open circuit

Q: Is the lock switch (front door: RH) normal?

YES : Go to Step 4.

NO : Replace the door outside handle base (front door: RH).

STEP 4. Check the wiring harness between KOS-ECU connector C-05 (terminal No. 23) and lock switch (front door: RH) connector E-06 (terminal No. 1), and between lock switch (front door: RH) connector E-06 (terminal No. 2) and ground.

- Check the signal and ground wires for open circuit.

NOTE: Also check intermediate connectors C-116, C-117 for loose, corroded, or damaged terminals, or terminals pushed back in the connector. If intermediate connectors C-116, C-117 is damaged, repair or replace the damaged component(s) as described in GROUP 00E, Harness Connector Inspection P.00E-2.

Q: Are the wiring harness between KOS-ECU connector C-05 (terminal No. 23) and lock switch (front door: RH) connector E-06 (terminal No. 1), and between lock switch (front door: RH) connector E-06 (terminal No. 2) and ground in good condition?

YES : Go to Step 5.

NO : The wiring harness may be damaged or the connector(s) may have loose, corroded or damaged terminals, or terminals pushed back in the connector. Repair the wiring harness as necessary. Check that the passenger's door lock switch works normally.

STEP 5. KOS communication test

Using scan tool (M.U.T-III), perform the antenna communication test to check that the exterior transmitter antenna (passenger's side) communicates normally (Refer to P.42B-227).

Q: Is the check result normal?

YES : Go to Step 6.

NO : Perform troubleshooting for the diagnostic trouble code No. B240B (Refer to P.42B-75).

STEP 6. Check of the troubles

Operate the lock switch (front door: RH) to check that the door can be locked.

Q: Is the check result normal?

YES : The diagnosis is complete.

NO : Replace KOS-ECU and register the ID codes (Refer to P.42B-11).

Inspection Procedure 12: Front passenger's door unlock sensor does not work.

CAUTION

Before replacing the ECU, ensure that the power supply circuit, the ground circuit and the communication circuit are normal.

Unlock Sensor (Front Door: RH) Circuit

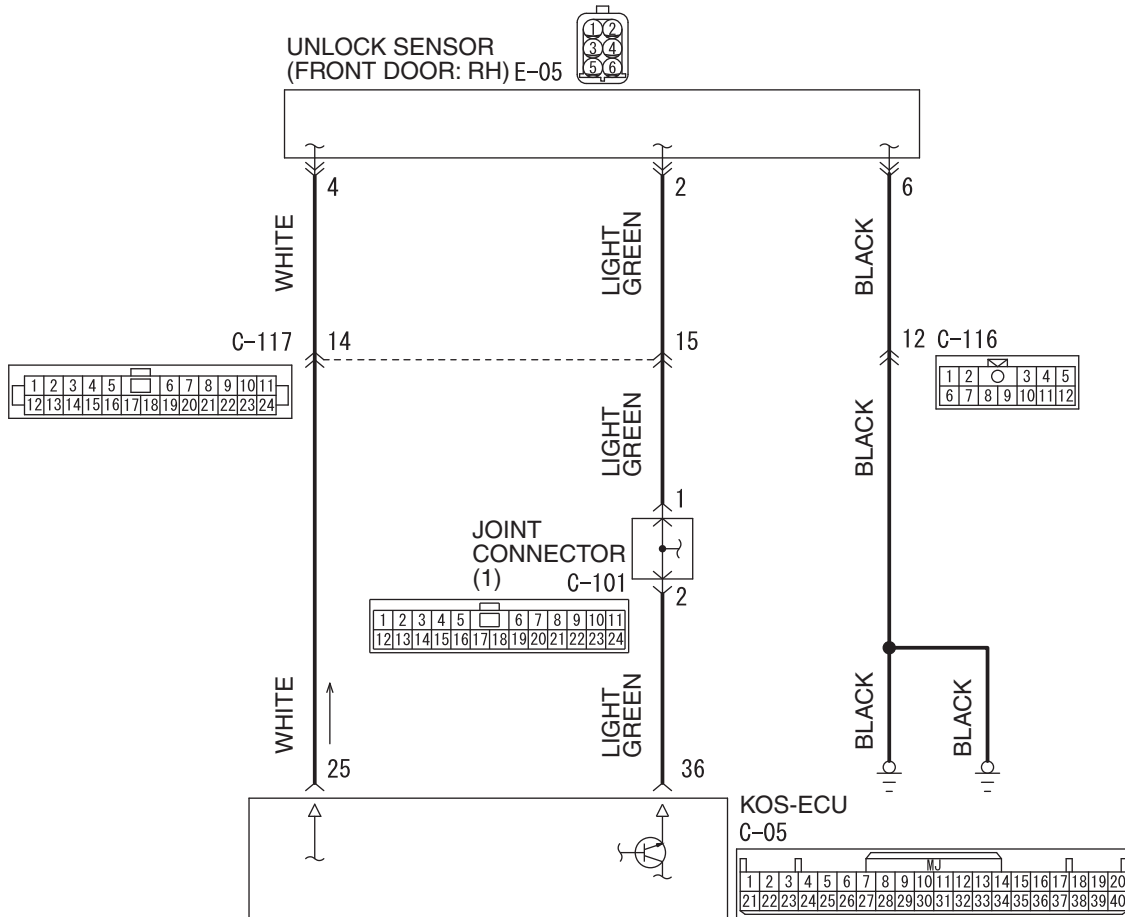

AC709310AB

Connectors: C-05, C-101

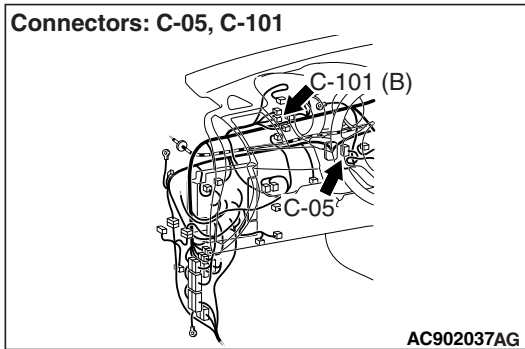

AC902037AG

Connector: E-05

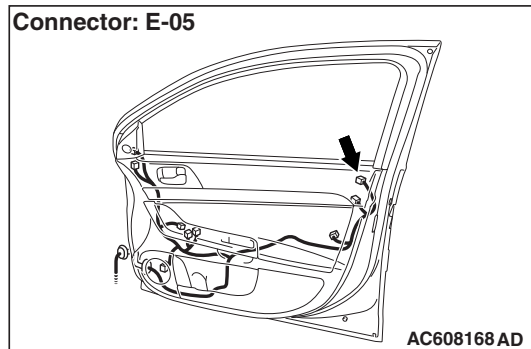

AC608168AD

Connectors: C-116, C-117

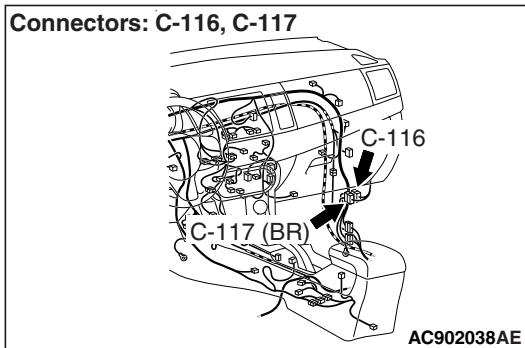

AC902038AE

TROUBLESHOOTING HINTS

- Malfunction of the exterior transmitter antenna assembly (front passenger's side)
- Malfunction of the unlock switch (front door: RH)
- Damaged wiring harness and connectors
- Malfunction of the KOS-ECU

DIAGNOSIS

Required Special Tools:

- MB992006: Extra fine probe
- MB991223: Harness set
- MB991958: Scan Tool (M.U.T.-III Sub Assembly)
 - MB991824: Vehicles Communication Interface (V.C.I.)
 - MB991827: M.U.T.-III USB Cable
 - MB991910: M.U.T.-III Main Harness A

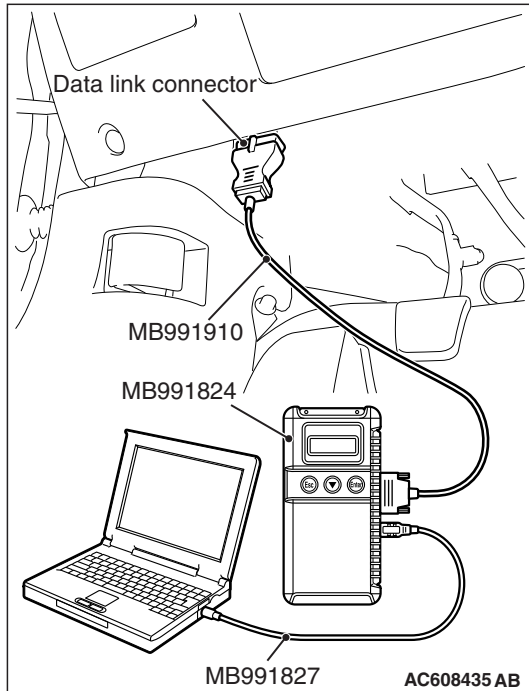

STEP 1. Using scan tool MB991958, read the diagnostic trouble code.

⚠ CAUTION

To prevent damage to scan tool MB991958, always turn the ignition switch to the "LOCK" (OFF) position before connecting or disconnecting scan tool MB991958.

- (1) Connect scan tool MB991958. Refer to "How to connect scan tool (M.U.T.-III) P.42B-9."
- (2) Turn the ignition switch to the "ON" position.
- (3) Check whether the KOS-ECU related DTC is set.
- (4) Turn the ignition switch to the "LOCK" (OFF) position.

Q: Is the DTC set?

YES : Diagnose the KOS-ECU. Refer to P.42B-23.

NO : Go to Step 2.

STEP 2. Check KOS-ECU connector C-05 and unlock sensor (front door: RH) connector E-05 for loose, corroded or damaged terminals, or terminals pushed back in the connector.

Q: Are KOS-ECU connector C-05 and unlock sensor (front door: RH) connector E-05 in good condition?

YES : Go to Step 3.

NO : Repair or replace the damaged component(s). Refer to GROUP 00E, Harness Connector Inspection P.00E-2. Check that the passenger's door unlock sensor works normally.

STEP 3. Check the wiring harness between KOS-ECU connector C-05 (terminal Nos. 25 and 36) and unlock sensor (front door: RH) connector E-05 (terminal Nos. 4 and 2), and between unlock sensor (front door: RH) connector E-05 (terminal No. 6) and ground.

- Check the signal and ground wires for open circuit.

NOTE: Also check joint connector (1) C-101, intermediate connectors C-116, C-117 for loose, corroded, or damaged terminals, or terminals pushed back in the connector. If joint connector (1) C-101, intermediate connectors C-116, C-117 is damaged, repair or replace the damaged component(s) as described in GROUP 00E, Harness Connector Inspection P.00E-2.

Q: Are the wiring harness between KOS-ECU connector C-05 (terminal Nos. 25 and 36) and unlock sensor (front door: RH) connector E-05 (terminal Nos. 4 and 2), and between unlock sensor (front door: RH) connector E-05 (terminal No. 6) and ground in good condition?

YES : Go to Step 4.

NO : The wiring harness may be damaged or the connector(s) may have loose, corroded or damaged terminals, or terminals pushed back in the connector. Repair the wiring harness as necessary. Check that the passenger's door unlock sensor works normally.

STEP 4. KOS communication test

Using scan tool (M.U.T-III), perform the antenna communication test to check that the exterior transmitter antenna (passenger's side) communicates normally (Refer to [P.42B-227](#)).

Q: Is the check result normal?

YES : Go to Step 5.

NO : Perform troubleshooting for the diagnostic trouble code No. B240B (Refer to [P.42B-75](#)).

STEP 5. Check of the troubles

Operate the unlock sensor (front door: RH) and check that the door can be locked.

Q: Is the check result normal?

YES : The diagnosis is complete.

NO : Replace KOS-ECU and register the ID codes (Refer to [P.42B-11](#)).

Inspection Procedure 13: Trunk lid opener switch does not work.

CAUTION

Before replacing the ECU, ensure that the power supply circuit, the ground circuit and the communication circuit are normal.

Trunk Lid Opener Switch Circuit

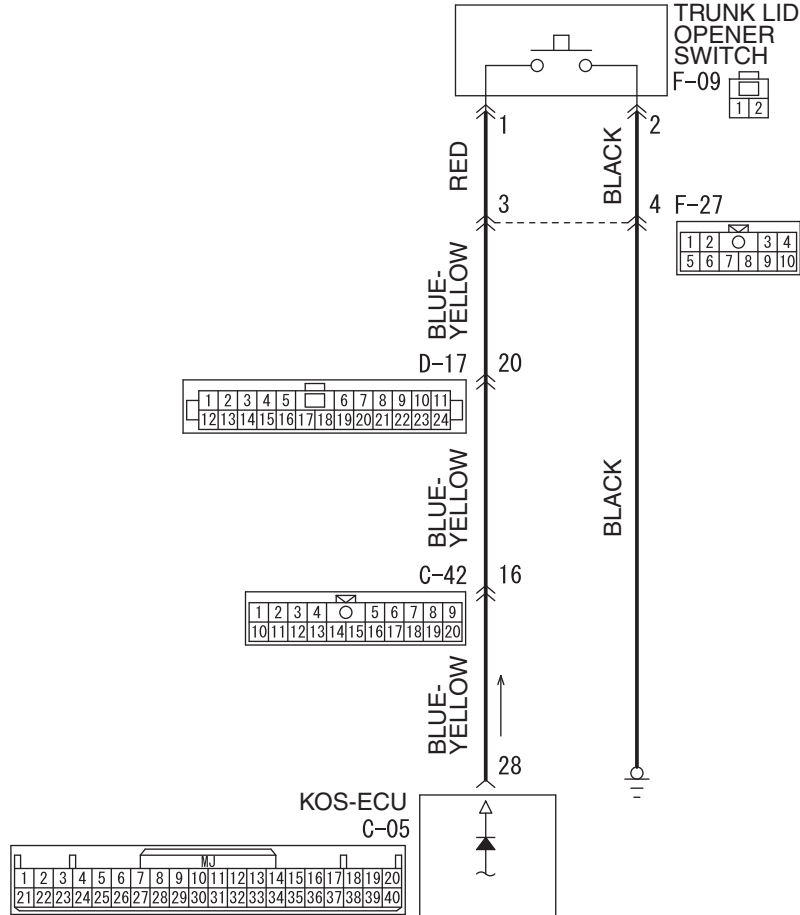

AC609043AC

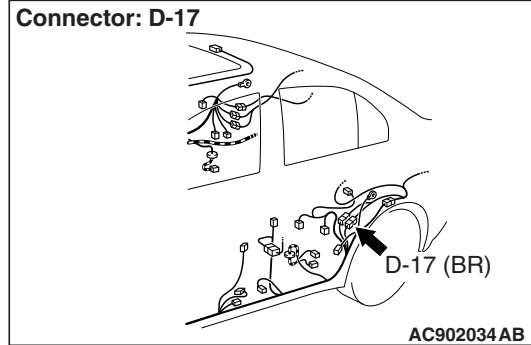
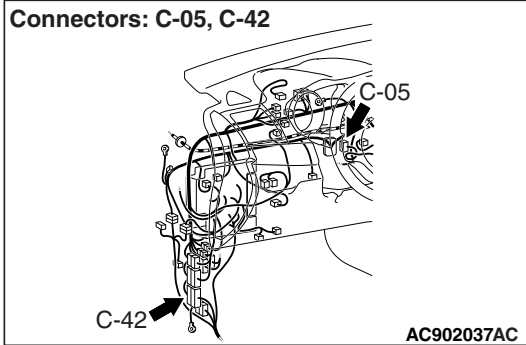

Connectors: F-09, F-27

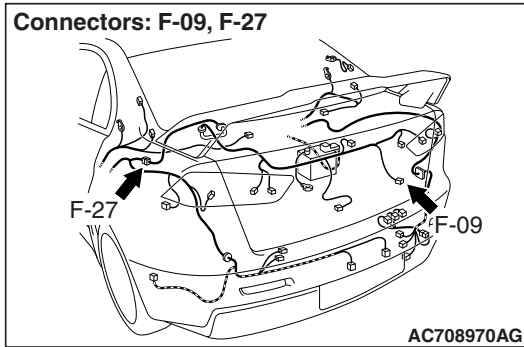

TROUBLESHOOTING HINTS

- Malfunction of the exterior transmitter antenna assembly (trunk lid)
- Malfunction of the trunk lid opener switch
- Damaged wiring harness and connectors
- Malfunction of the KOS-ECU

DIAGNOSIS

Required Special Tools:

- MB992006: Extra fine probe
- MB991223: Harness set
- MB991958: Scan Tool (M.U.T.-III Sub Assembly)
 - MB991824: Vehicles Communication Interface (V.C.I.)
 - MB991827: M.U.T.-III USB Cable
 - MB991910: M.U.T.-III Main Harness A

STEP 1. Using scan tool MB991958, read the diagnostic trouble code.

⚠ CAUTION

To prevent damage to scan tool MB991958, always turn the ignition switch to the "LOCK" (OFF) position before connecting or disconnecting scan tool MB991958.

- (1) Connect scan tool MB991958. Refer to "How to connect scan tool (M.U.T.-III) P.42B-9."
- (2) Turn the ignition switch to the "ON" position.
- (3) Check whether the KOS-ECU related DTC is set.
- (4) Turn the ignition switch to the "LOCK" (OFF) position.

Q: Is the DTC set?

- YES** : Diagnose the KOS-ECU. Refer to P.42B-23.
NO : Go to Step 2.

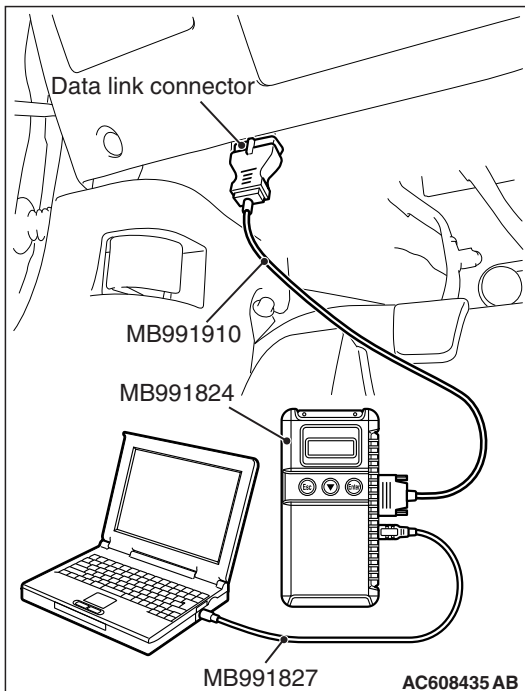

STEP 2. Check KOS-ECU connector C-05 and trunk lid opener switch connector F-09 for loose, corroded or damaged terminals, or terminals pushed back in the connector.

Q: Are KOS-ECU connector C-05 and trunk lid opener switch connector F-09 in good condition?

YES : Go to Step 3.

NO : Repair or replace the damaged component(s). Refer to GROUP 00E, Harness Connector Inspection [P.00E-2](#). Check that the trunk lid opener switch works normally.

STEP 3. Check the trunk lid opener switch.

- (1) Remove the trunk lid opener switch. Refer to GROUP 42A, Trunk Lid [P.42A-153](#).
- (2) Check continuity when the trunk lid opener switch is operated to "ON" or "OFF" position.

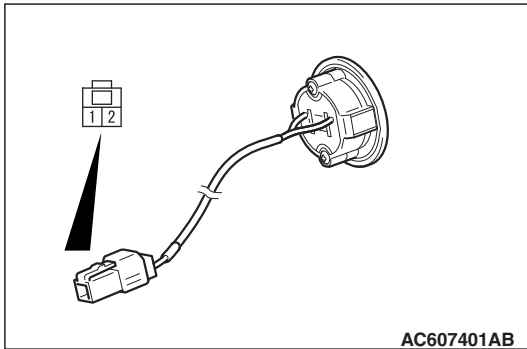

Switch position	Terminal number	Specified condition
ON (Push)	1 -2	Continuity exists (2 Ω or less)
OFF (Release)	1 -2	Open circuit

Q: Is the trunk lid opener switch normal?

YES : Go to Step 4.

NO : Replace the trunk lid opener switch.

STEP 4. Check the wiring harness between KOS-ECU connector C-05 (terminal No. 28) and trunk lid opener switch connector F-09 (terminal No. 1), and between trunk lid opener switch connector F-09 (terminal No. 2) and ground.

- Check the signal and ground wires for open circuit.

NOTE: Also check intermediate connectors C-42, D-17, F-27 for loose, corroded, or damaged terminals, or terminals pushed back in the connector. If intermediate connectors C-42, D-17, F-27 is damaged, repair or replace the damaged component(s) as described in GROUP 00E, Harness Connector Inspection P.00E-2.

Q: Are the wiring harness between KOS-ECU connector C-05 (terminal No. 28) and trunk lid opener switch connector F-09 (terminal No. 1), and between trunk lid opener switch connector F-09 (terminal No. 2) and ground in good condition?

YES : Go to Step 5.

NO : The wiring harness may be damaged or the connector(s) may have loose, corroded or damaged terminals, or terminals pushed back in the connector. Repair the wiring harness as necessary. Check that the trunk lid opener switch works normally.

STEP 5. KOS communication test

Using scan tool (M.U.T.-III), perform the antenna communication test to check that the exterior transmitter antenna (trunk lid side) is normal (Refer to [P.42B-227](#)).

Q: Is the check result normal?

YES : Go to Step 6.

NO : Perform troubleshooting for the diagnostic trouble code No. B240C (Refer to [P.42B-78](#)).

STEP 6. Check of the troubles

Operate the trunk lid opener switch to check that the trunk lid can be opened.

Q: Is the check result normal?

YES : The diagnosis is complete.

NO : Replace KOS-ECU and register the ID codes (Refer to [P.42B-11](#)).

Inspection Procedure 14: Keyless entry system does not work.

CAUTION

Before replacing the ECU, ensure that the power supply circuit, the ground circuit and the communication circuit are normal.

KOS-ECU System Input Signal

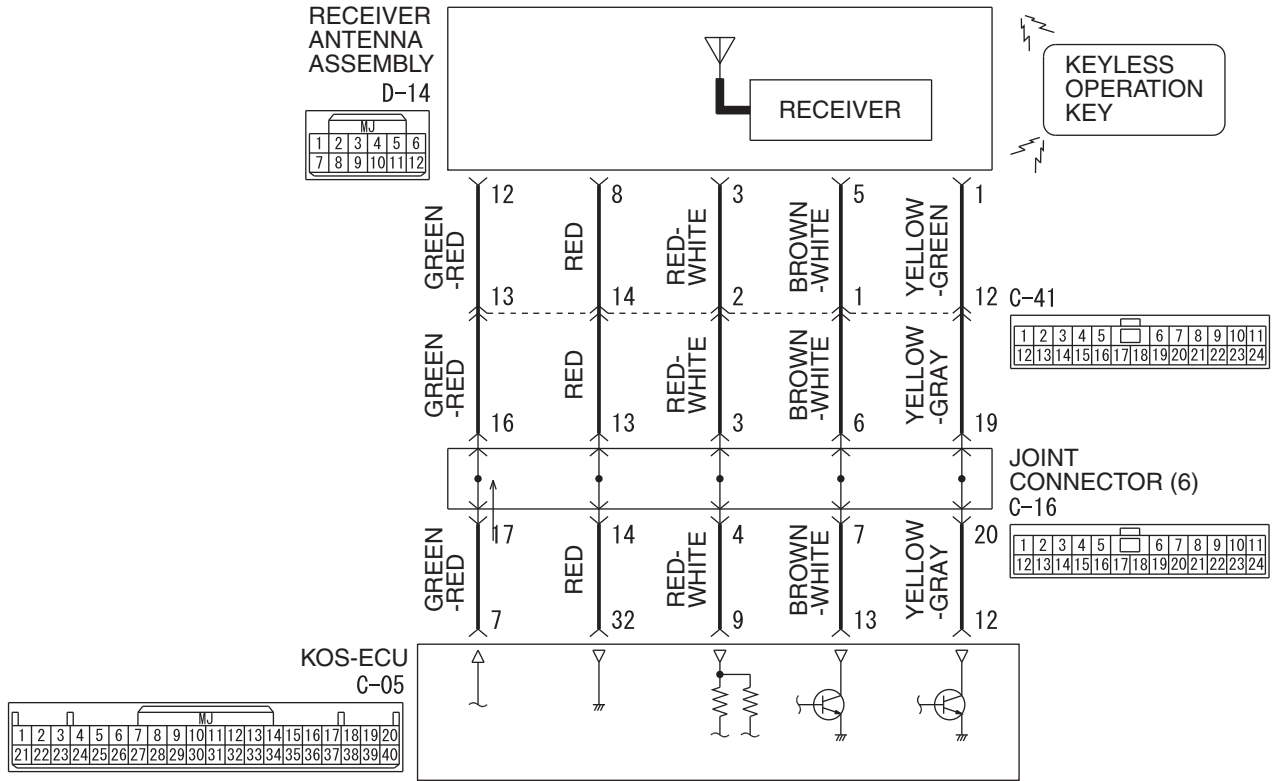

AC709247AB

Connectors: C-05, C-41

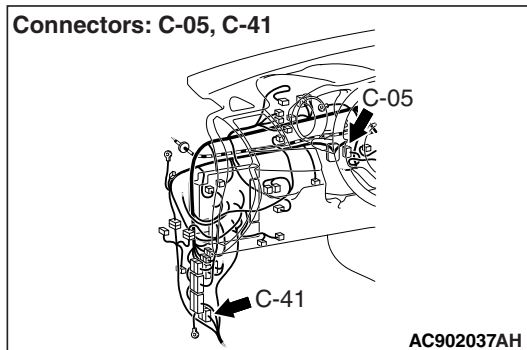

AC902037AH

Connector: C-16

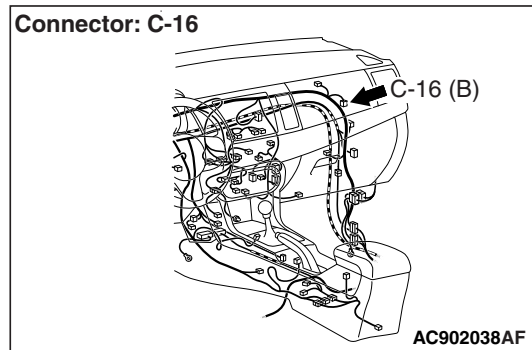

AC902038AF

Connector: D-14

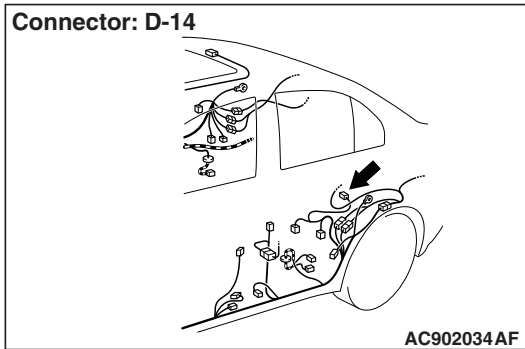

TECHNICAL DESCRIPTION (COMMENT)

The receiver antenna module assembly lock and unlock signals from the keyless operation key, and sends them to KOS-ECU, and further to ETACS-ECU. Also, when ETACS receives signals from the key reminder switch and all the door switches, ETACS-ECU judges them to activate the keyless entry system.

TROUBLESHOOTING HINTS

- Malfunction of CAN bus line
- Malfunction of the door switches
- Malfunction of the key reminder switch
- Malfunction of the receiver antenna assembly
- Malfunction of the keyless operation key
- Damaged wiring harness and connectors
- Malfunction of the KOS-ECU
- Malfunction of ETACS-ECU

DIAGNOSIS

Required Special Tools:

- MB992006: Extra fine probe
- MB991223: Harness set
- MB991958 Scan Tool (M.U.T.-III Sub Assembly)
 - MB991824: Vehicles Communication Interface (V.C.I.)
 - MB991827 M.U.T.-III USB Cable
 - MB991910 M.U.T.-III Main Harness A

STEP 1. Using scan tool MB991958, read CAN bus the diagnostic trouble code.

⚠ CAUTION

To prevent damage to scan tool MB991958, always turn the ignition switch to the "LOCK" (OFF) position before connecting or disconnecting scan tool MB991958.

- (1) Connect scan tool MB991958. Refer to "How to connect scan tool (M.U.T.-III) [P.42B-9](#)."
- (2) Turn the ignition switch to the "ON" position.
- (3) Diagnose the CAN bus line.
- (4) Turn the ignition switch to the "LOCK" (OFF) position.

Q: Is the CAN bus line found to be normal?

YES : Go to Step 2.

NO : Repair the CAN bus line (Refer to GROUP 54C, Diagnosis [P.54C-15](#)).

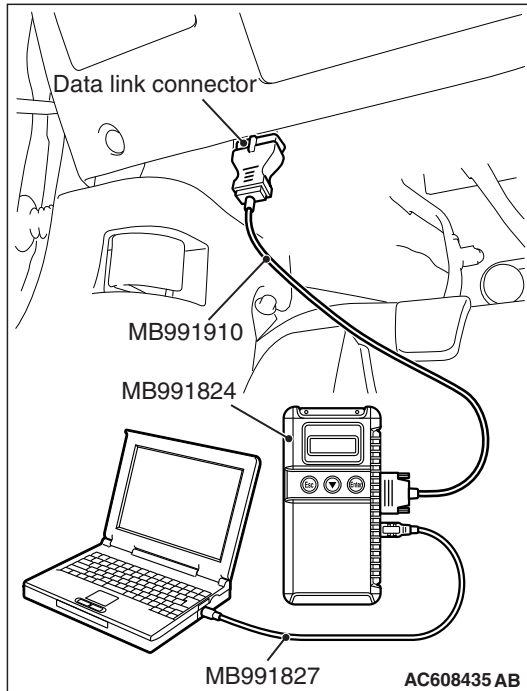

STEP 2. Using scan tool MB991958, read the diagnostic trouble code.

⚠ CAUTION

To prevent damage to scan tool MB991958, always turn the ignition switch to the "LOCK" (OFF) position before connecting or disconnecting scan tool MB991958.

- (1) Connect scan tool MB991958. Refer to "How to connect scan tool (M.U.T.-III) [P.42B-9](#)."
- (2) Turn the ignition switch to the "ON" position.
- (3) Check whether the KOS-ECU related DTC is set.
- (4) Turn the ignition switch to the "LOCK" (OFF) position.

Q: Is the DTC set?

YES : Diagnose the KOS-ECU. Refer to [P.42B-23](#).

NO : Go to Step 3.

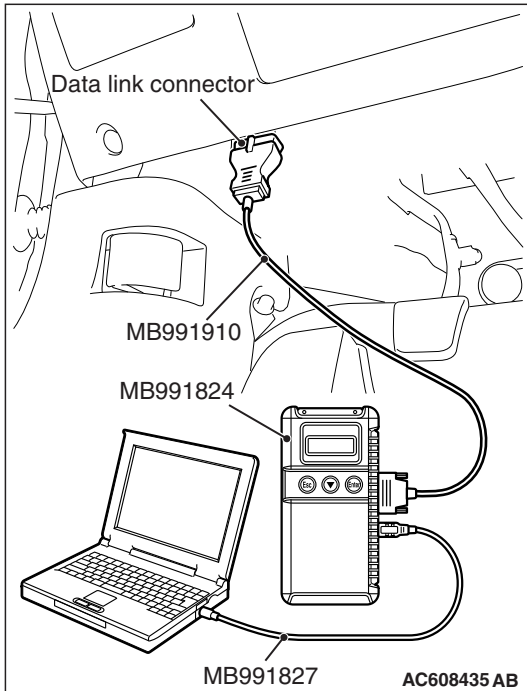

STEP 3. Check the power supply system

With the ignition switch in the LOCK (OFF) position, check if the following function operates normally:

- Headlights
- Hazard warning light

Q: Is the check result normal?

YES : Go to Step 4.

NO : Refer to GROUP 54A –Malfunction of ETACS-ECU power supply circuit [P.54A-700](#).

STEP 4. Verify the central door locking system.

Check that the central door locking system works normally.

Q: Is the check result normal?

YES : Go to Step 5.

NO : Refer to GROUP 42A –Troubleshooting [P.42A-30](#).

STEP 5. Using scan tool MB991958, check data list.

Check the signals related to the keyless entry system operation.

⚠ CAUTION

To prevent damage to scan tool MB991958, always turn the ignition switch to the "LOCK" (OFF) position before connecting or disconnecting scan tool MB991958.

(1) Connect scan tool MB991958. Refer to "How to connect the Scan Tool (M.U.T.-III) P.42C-6."

(2) Turn the ignition switch to the "LOCK" (OFF) position.

(3) Check the ETACS data list.

- Close the driver's door.
- Close the passenger's door.
- Close the RH-side rear door.
- Close the LH-side rear door.
- Close the trunk lid.
- Remove the ignition key from the ignition key cylinder.

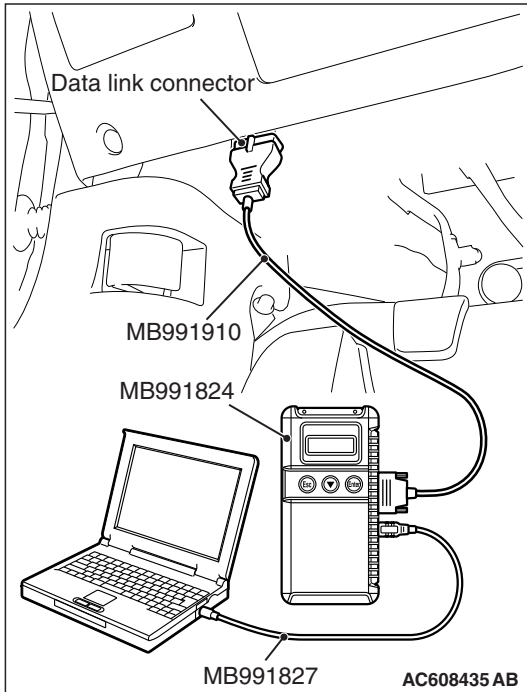

Item No.	Item name	Normal condition
Item 256	Dr door ajar switch	Close
Item 257	As door ajar switch	Close
Item 258	RR door ajar switch	Close
Item 259	RL door ajar switch	Close
Item 260	Trunk/gate trunk ajar switch	Close
Item 264	Handle lock switch	Key in →Key out

OK: Normal condition are displayed.

Q: Are the check result normal?

YES <Normal conditions are displayed for all the items.> : Go to Step 6.

NO <Normal condition is not displayed for item No. 256.> : Refer to GROUP 54A, Inspection Procedure 5: ETACS-ECU does not receive any signal from the front door switch (LH) P.54A-721.

NO <Normal condition is not displayed for item No. 257.> : Refer to GROUP 54A, Inspection Procedure 6: ETACS-ECU does not receive any signal from the front door switch (RH) P.54A-719.

NO <Normal condition is not displayed for item No. 258.> : Refer to GROUP 54A, Inspection Procedure 8: ETACS-ECU does not receive any signal from the rear door switch (RH) P.54A-726.

NO <Normal condition is not displayed for item No. 259.> : Refer to GROUP 54A, Inspection Procedure 7: ETACS-ECU does not receive any signal from the rear door switch (LH) P.54A-724.

NO <Normal condition is not displayed for item No. 260.> : Refer to GROUP 54A, Inspection Procedure 9: ETACS-ECU does not receive any signal from the trunk lid latch. [P.54A-729](#).

NO <Normal condition is not displayed for item No. 264.> : Refer to GROUP 54A, Inspection Procedure 3: ETACS-ECU does not receive any signal from the key reminder switch. [P.54A-709](#).

STEP 6. Check KOS-ECU connector C-05 and receiver antenna assembly connector D-14 for loose, corroded or damaged terminals, or terminals pushed back in the connector.

Q: Are KOS-ECU connector C-05 and receiver antenna assembly connector D-14 in good condition?

YES : Go to Step 7.

NO : Repair or replace the damaged component(s). Refer to GROUP 00E, Harness Connector Inspection [P.00E-2](#). Check that the keyless entry system works normally.

STEP 7. Check the wiring harness between KOS-ECU connector C-05 (terminal Nos. 7, 9, 12, 13 and 32) and receiver antenna assembly connector D-14 (terminal Nos. 12, 3, 1, 5 and 8).

- Check the communication and ground lines for open circuit or short circuit.

NOTE: Also check joint connector (6) C-16 and intermediate connector C-41 for loose, corroded, or damaged terminals, or terminals pushed back in the connector. If joint connector (6) C-16 and intermediate connector C-41 is damaged, repair or replace the damaged component(s) as described in GROUP 00E, Harness Connector Inspection [P.00E-2](#).

Q: Are the wiring harness between KOS-ECU connector C-05 (terminal Nos. 7, 9, 12, 13 and 32) and receiver antenna assembly connector D-14 (terminal Nos. 12, 3, 1, 5 and 8) in good condition?

YES : Go to Step 8.

NO : The wiring harness may be damaged or the connector(s) may have loose, corroded or damaged terminals, or terminals pushed back in the connector. Repair the wiring harness as necessary. Check that the keyless entry system works normally.

STEP 8. Check with another registered keyless operation key.

Check that the keyless entry function can be used with another keyless operation key.

Q: Can the keyless entry function be used?

YES : Replace the keyless operation key concerned and register the ID codes (Refer to [P.42B-11](#)).

NO : Go to Step 9.

STEP 9. Check of the troubles

Replace receiver antenna assembly. After the replacement, perform the coding, and check that the keyless entry system operates normally.

Q: Is the check result normal?

YES : The diagnosis is complete.

NO : Replace KOS-ECU and register the ID codes (Refer to [P.42B-11](#)).

Inspection Procedure 15: KOS timer lock function does not work.

⚠ CAUTION

Before replacing the ECU, ensure that the power supply circuit, the ground circuit and the communication circuit are normal.

TECHNICAL DESCRIPTION (COMMENT)

After the door is unlocked with the keyless entry function, if no operation is performed, the door is locked when the time specified by a customization function has elapsed. However, an open signal from any door, key reminder switch OFF (with the key inserted) signal, or ignition push switch ON signal has been input to ETACS, the KOS timer will not operate.

TROUBLESHOOTING HINTS

- Malfunction of ETACS-ECU
- Malfunction of the door switches

DIAGNOSIS**Required Special Tools:**

- MB992006: Extra fine probe
- MB991223: Harness set
- MB991958 Scan Tool (M.U.T.-III Sub Assembly)
 - MB991824: Vehicles Communication Interface (V.C.I.)
 - MB991827 M.U.T.-III USB Cable
 - MB991910 M.U.T.-III Main Harness A

STEP 1. Check the operation of the keyless operation system (keyless entry system).

Operate the keyless operation key and check that all doors lock and unlock.

Q: Is the check result normal?

YES : Go to Step 2.

NO : Refer to inspection procedure 14: "Keyless entry system does not work [P.42B-204](#)."

STEP 2. Using scan tool MB991958, read the diagnostic trouble code.

⚠ CAUTION

To prevent damage to scan tool MB991958, always turn the ignition switch to the "LOCK" (OFF) position before connecting or disconnecting scan tool MB991958.

- (1) Connect scan tool MB991958. Refer to "How to connect scan tool (M.U.T.-III) [P.42B-9](#)."
- (2) Turn the ignition switch to the "ON" position.
- (3) Check whether the KOS-ECU related DTC is set.
- (4) Turn the ignition switch to the "LOCK" (OFF) position.

Q: Is the DTC set?

YES : Diagnose the KOS-ECU. Refer to [P.42B-23](#).

NO : Go to Step 3.

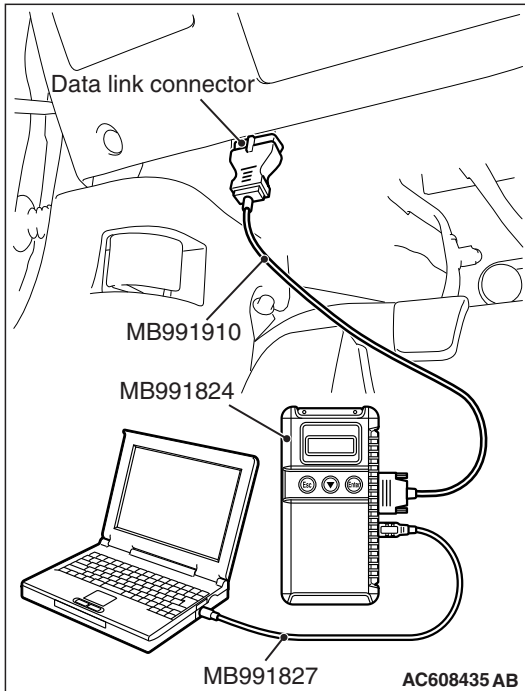

STEP 3. Check of the troubles

Check that the KOS timer lock function operates.

Q: Is the check result normal?

YES : The diagnosis is complete.

NO : Perform troubleshooting for each door switch (Refer to GROUP 54A –ETACS –Troubleshooting [P.54A-703](#)).

Inspection Procedure 16: Keyless entry hazard light answerback function, the dome light answerback function or the horn answerback function does not work normally.

⚠ CAUTION

Before replacing the ECU, ensure that the power supply circuit, the ground circuit and the communication circuit are normal.

TECHNICAL DESCRIPTION (COMMENT)

When the keyless entry function is used, the keyless entry hazard answerback function, dome light answerback function or horn answerback function operate as set by ETACS customization function (If the flashing count is set to 0 with a customization function, no answerback function is performed).

TROUBLESHOOTING HINTS

- Function setting error or no setting with a customization
- Malfunction of the turn signal lights
- Malfunction of the dome light
- Malfunction of the horn
- Malfunction of ETACS-ECU

DIAGNOSIS

STEP 1. Verify the operation hazard warning light

Check that the hazard warning light illuminate normally.

Q: Is the check result normal?

YES : Go to Step 2.

NO : Refer to GROUP 54A –inspection procedure 1: "Hazard warning light does not illuminate [P.54A-287](#)."

STEP 2. Verify the operation of the dome light.

Check that the dome lights illuminate normally.

Q: Is the check result normal?

YES : Go to Step 3.

NO : Refer to GROUP 54A –inspection procedure 1 "The front dome light does not illuminate normally [P.54A-264](#)." or inspection procedure 2 "The rear dome light does not illuminate normally [P.54A-269](#)."

STEP 3. Verify the horn.

Check that the horn normally.

Q: Is the check result normal?

YES : Go to Step 4.

NO : Replace the horn (Refer to GROUP 54A, Horn [P.54A-289](#)).

STEP 4. Check the operation of the keyless entry system.

Operate the keyless operation key and check that all doors lock and unlock.

Q: Is the check result normal?

YES : Go to Step 5.

NO : Refer to inspection procedure 14: "Keyless entry system does not work [P.42B-204](#)."

STEP 5. Check the customize function.

Check that any one of the followings other than "Lock: 0, Unlock: 0" is set for "Hazard answerback" with a customization function.

- Lock:1, Unlock:2
- Lock:1, Unlock:0
- Lock:0, Unlock:2
- Lock:2, Unlock:1
- Lock:2, Unlock:0
- Lock:0, Unlock:1

Q: Is the check result normal?

YES : Go to Step 6.

NO : Set "Hazard answerback" to any one other than "Lock: 0, Unlock: 0" with a customization function (Refer to [P.42C-129](#)).

STEP 6. Check the customize function.

Check that any one of the followings other than "Not sound horn" is set for "Horn chirp by keyless entry system <vehicles without auto light>" or "Horn chirp by keyless entry system <vehicles with auto light>" with a customization function.

<Vehicles without auto light>

- Lock any time
- W lock any time

<Vehicles with auto light>

- Lock any time
- Lock/auto ON
- W lock any time

Q: Is the check result normal?

YES : Go to Step 7.

NO : Set "Horn chirp by keyless entry system <vehicles without auto light>" or "Horn chirp by keyless entry system <vehicles with auto light>" to any one other than "Not sound horn" with a customization function (Refer to [P.42C-129](#)).

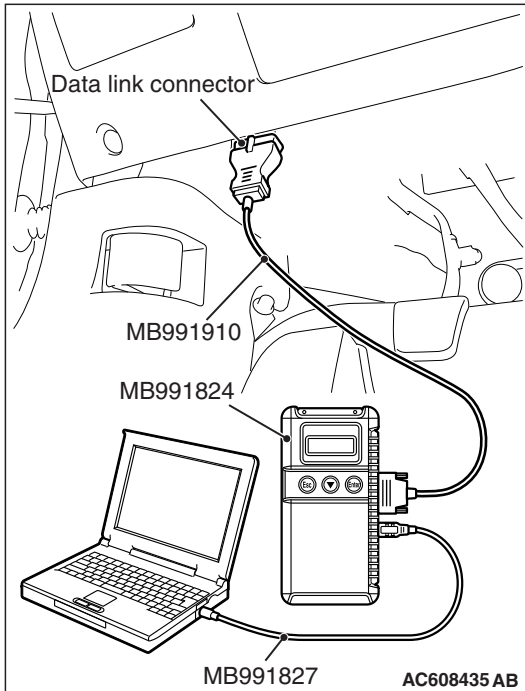

STEP 7. Using scan tool MB991958, read the diagnostic trouble code.

⚠ CAUTION

To prevent damage to scan tool MB991958, always turn the ignition switch to the "LOCK" (OFF) position before connecting or disconnecting scan tool MB991958.

- (1) Connect scan tool MB991958. Refer to "How to connect scan tool (M.U.T.-III) P.42B-9."
- (2) Turn the ignition switch to the "ON" position.
- (3) Check whether the KOS-ECU related DTC is set.
- (4) Turn the ignition switch to the "LOCK" (OFF) position.

Q: Is the DTC set?

YES : Diagnose the KOS-ECU. Refer to P.42B-23.

NO : Go to Step 8.

STEP 8. Check of the troubles

Check if the keyless entry answerback function works normally.

Q: Is the check result normal?

YES : The diagnosis is complete.

NO : Replace ETACS-ECU.

Inspection Procedure 17: The Trunk is not opened when the keyless operation key "TRUNK" button is operated.

CAUTION

Before replacing the ECU, ensure that the power supply circuit, the ground circuit and the communication circuit are normal.

Keyless Operation Key "TRUNK" Input Signal

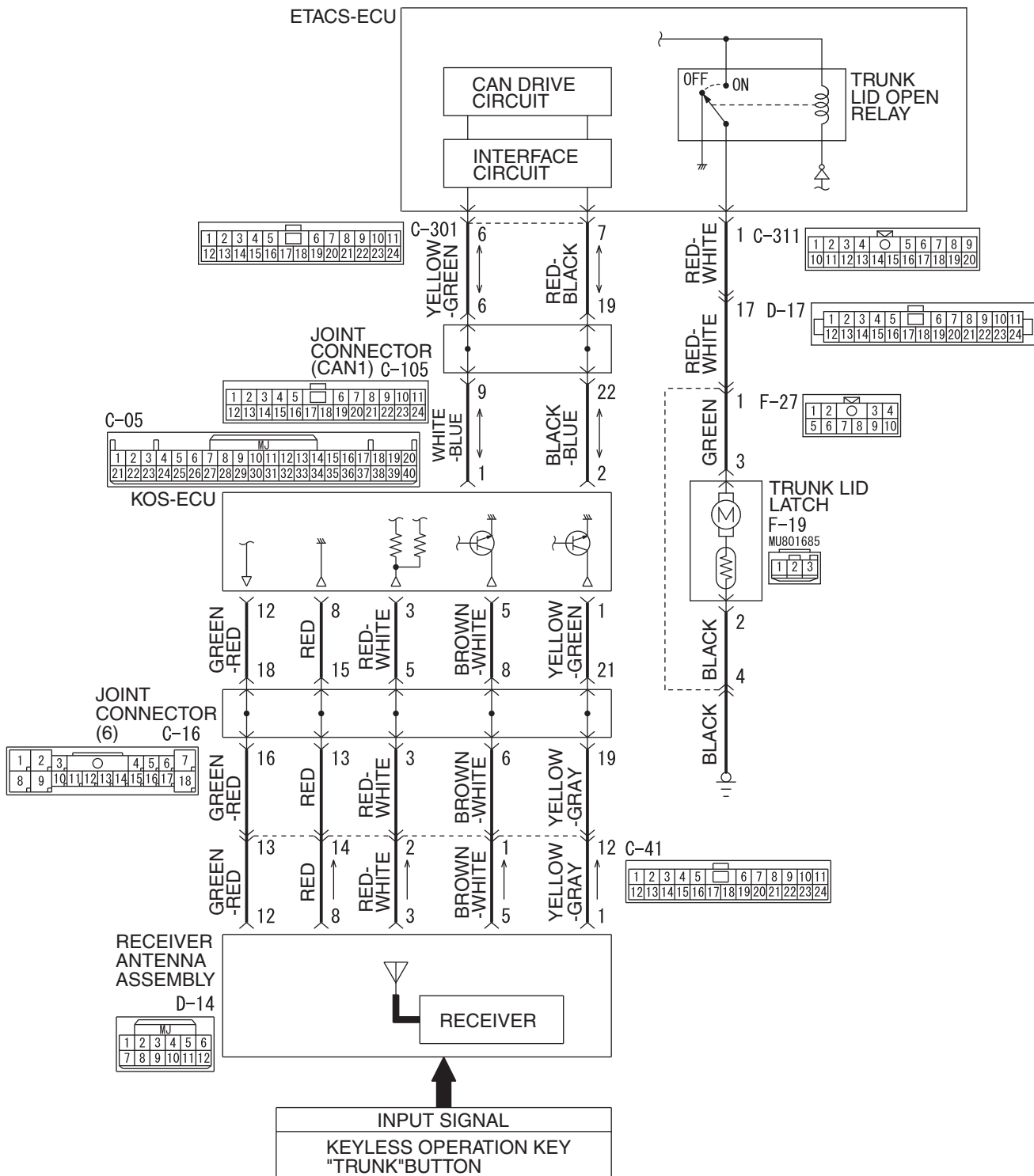

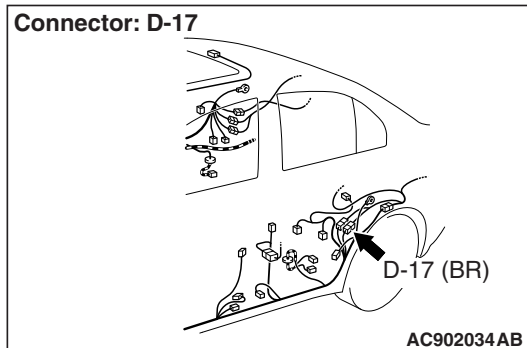
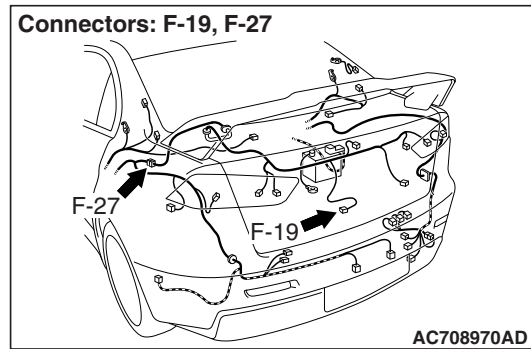
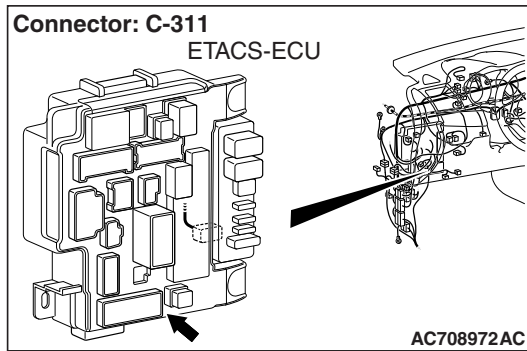

TECHNICAL DESCRIPTION (COMMENT)

The receiver antenna assembly receives the trunk signals from the keyless operation key, and sends them to KOS-ECU, and further to ETACS-ECU. Then the ETACS-ECU determines to actuate the trunk open function of the keyless entry system.

TROUBLESHOOTING HINTS

- The keyless operation key may be defective
- The receiver antenna assembly may be defective
- The KOS-ECU may be defective
- The ETACS-ECU may be defective
- The wiring harness or connectors may have loose, corroded, or damaged terminals, or terminals pushed back in the connector

DIAGNOSIS

Required Special Tools:

- MB992006: Extra fine probe
- MB991223: Harness set
- MB991958 Scan Tool (M.U.T.-III Sub Assembly)
 - MB991824: Vehicles Communication Interface (V.C.I.)
 - MB991827 M.U.T.-III USB Cable
 - MB991910 M.U.T.-III Main Harness A

STEP 1. Check the operation of the keyless operation system (keyless entry system).

Operate the keyless operation key and check that all doors lock and unlock.

Q: Is the check result normal?

YES : Go to Step 2.

NO : Refer to inspection procedure 14: "Keyless entry system does not work [P.42B-204](#)."

STEP 2. Using scan tool MB991958, read the diagnostic trouble code.

⚠ CAUTION

To prevent damage to scan tool MB991958, always turn the ignition switch to the "LOCK" (OFF) position before connecting or disconnecting scan tool MB991958.

- (1) Connect scan tool MB991958. Refer to "How to connect scan tool (M.U.T.-III) [P.42B-9](#)."
- (2) Turn the ignition switch to the "ON" position.
- (3) Check whether the KOS-ECU related DTC is set.
- (4) Turn the ignition switch to the "LOCK" (OFF) position.

Q: Is the DTC set?

YES : Diagnose the KOS-ECU. Refer to [P.42B-23](#).

NO : Go to Step 3.

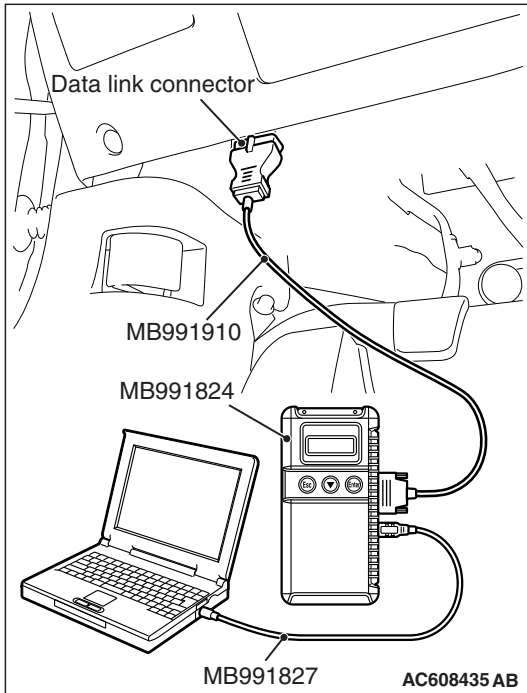

STEP 3. Check trunk lid latch connector F-19 and ETACS-ECU connector C-311 for loose, corroded or damaged terminals, or terminals pushed back in the connector.

Q: Is trunk lid latch connector F-19 and ETACS-ECU connector C-311 in good condition?

YES : Go to Step 4.

NO : Repair or replace the damaged component(s). Refer to GROUP 00E, Harness Connector Inspection [P.00E-2](#).

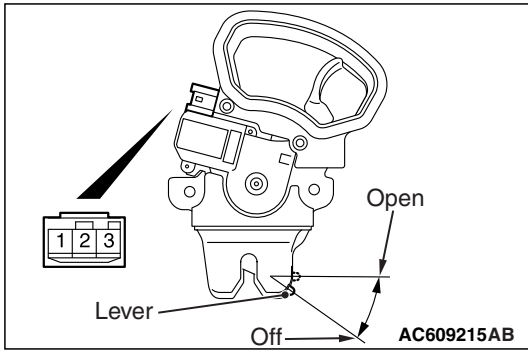

STEP 4. Check the trunk lid latch assembly.

Remove the trunk lid latch assembly. Refer to GROUP 42A, Trunk lid removal and installation P.42A-153.

Lever position	Battery connection	Lever operation
At the "OFF" position	<ul style="list-style-type: none"> Connect terminal No.2 and the negative battery terminal. Connect terminal No.3 and the positive battery terminal. 	The lever moves from the "OFF" position to the "OPEN" position.

Q: Is the trunk lid actuator normal?

YES : Go to Step 5.

NO : Replace the trunk lid latch assembly.

STEP 5. Check the ground circuit to the trunk lid lock actuator. Measure the resistance at trunk lid lock actuator connector F-19.

- Disconnect trunk lid lock actuator connector F-19 and measure the resistance available at the wiring harness side of the connector.
- Measure the resistance value between terminal 2 and ground.
 - The resistance should be 2 ohms or less.

Q: Is the measured resistance 2 ohms or less?

YES : Go to Step 7.

NO : Go to Step 6.

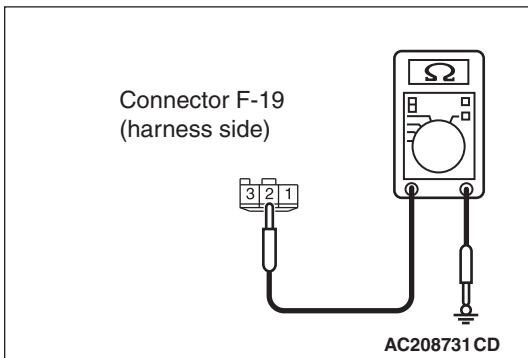

STEP 6. Check the wiring harness between trunk lid latch connector F-19 (terminal 2) and ground.

- Check the ground wires for open circuit.

NOTE: Also check intermediate connector F-27 for loose, corroded, or damaged terminals, or terminals pushed back in the connector. If intermediate connector F-27 is damaged, repair or replace the damaged component(s) as described in GROUP 00E, Harness Connector Inspection P.00E-2.

Q: Is the wiring harness between trunk lid latch connector F-19 (terminal 2) and ground in good condition?

YES : No action is necessary and testing is complete.

NO : The wiring harness may be damaged or the connector(s) may have loose, corroded or damaged terminals, or terminals pushed back in the connector. Repair the wiring harness as necessary. Check that the trunk lid opener function works normally.

STEP 7. Check the wiring harness between trunk lid latch connector F-19 (terminal 3) and ETACS-ECU connector C-311 (terminal 1).

- Check the input/output line for open or short circuit.

NOTE: Also check intermediate connectors D-17, F-27 for loose, corroded, or damaged terminals, or terminals pushed back in the connector. If intermediate connectors D-17, F-27 is damaged, repair or replace the damaged component(s) as described in GROUP 00E, Harness Connector Inspection P.00E-2.

Q: Is the wiring harness between trunk lid latch connector F-19 (terminal 3) and ETACS-ECU connector C-311 (terminal 1) in good condition?

YES : Go to Step 8.

NO : The wiring harness may be damaged or the connector(s) may have loose, corroded or damaged terminals, or terminals pushed back in the connector. Repair the wiring harness as necessary. Check that the trunk lid opener function works normally.

STEP 8. Check of the troubles

Operate the keyless operation key and check that the trunk lid can be opened.

Q: Is the check result normal?

YES : The diagnosis is complete.

NO : Replace the ETACS-ECU. When the ETACS-ECU is replaced, register the keyless ID. Refer to P.42C-116. The trunk lid can be opened by means of the keyless operation key.

Inspection Procedure 18: Outer tone alarm does not sound.

CAUTION

Before replacing the ECU, ensure that the power supply circuit, the ground circuit and the communication circuit are normal.

Outer Tone Alarm Circuit

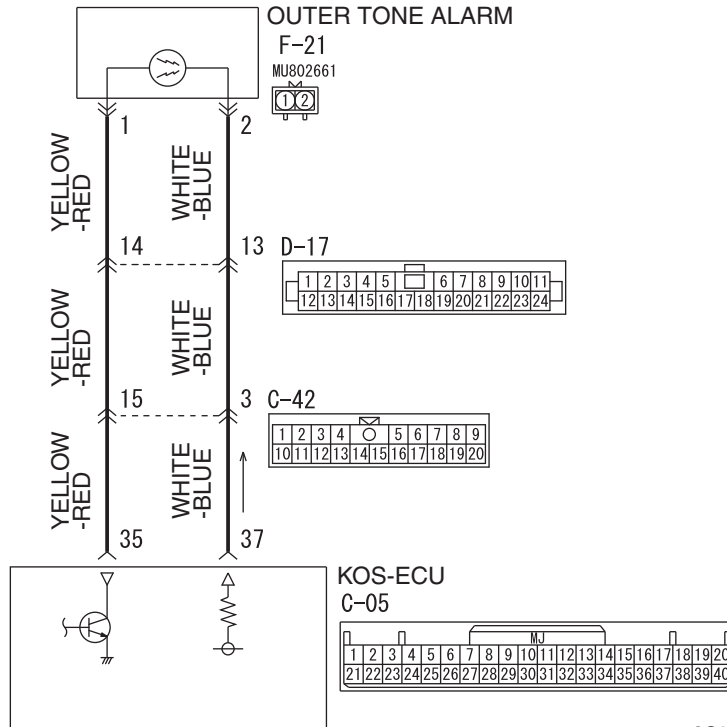

AC609041AG

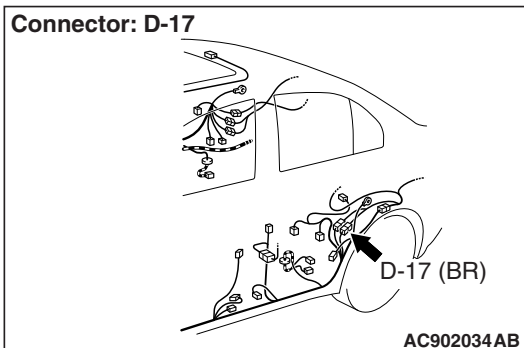
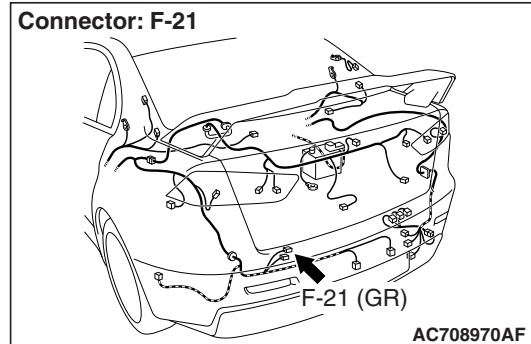
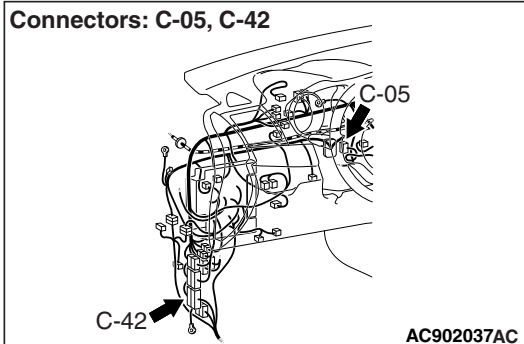

TECHNICAL DESCRIPTION (COMMENT)

The outer tone alarm sounds under the following conditions.

- When the door is locked or unlocked with the keyless or keyless operation function
- Door lock does not operate.
- The keyless operation key is brought out of the vehicle.

TROUBLESHOOTING HINTS

- Malfunction of the antenna and outer tone alarm assembly
- Malfunction of the KOS-ECU
- Damaged wiring harness and connectors

DIAGNOSIS

STEP 1. Check the customize function.

Check that either of the followings other than "Not sound tone alarm" is set for "Tone alarm answer back" with the customization function.

- At keyless
- At F.A.S.T.
- At Both

Q: Is the check result normal?

YES : Go to Step 2.

NO : Set either of the followings other than "Tone alarm answer back" with the customization function (Refer to [P.42B-238](#)).

STEP 2. Using scan tool MB991958, read the diagnostic trouble code.

CAUTION

To prevent damage to scan tool MB991958, always turn the ignition switch to the "LOCK" (OFF) position before connecting or disconnecting scan tool MB991958.

- (1) Connect scan tool MB991958. Refer to "How to connect scan tool (M.U.T.-III) [P.42B-9](#)."
- (2) Turn the ignition switch to the "ON" position.
- (3) Check whether the KOS-ECU related DTC is set.
- (4) Turn the ignition switch to the "LOCK" (OFF) position.

Q: Is the DTC set?

YES : Diagnose the KOS-ECU. Refer to [P.42B-23](#).

NO : Go to Step 3.

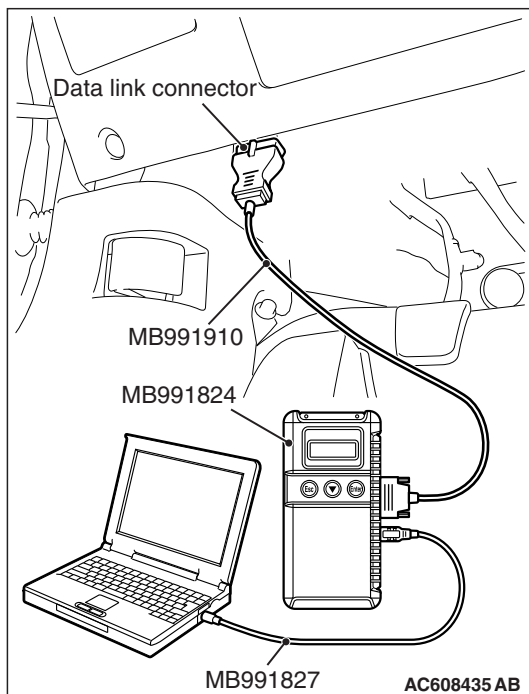

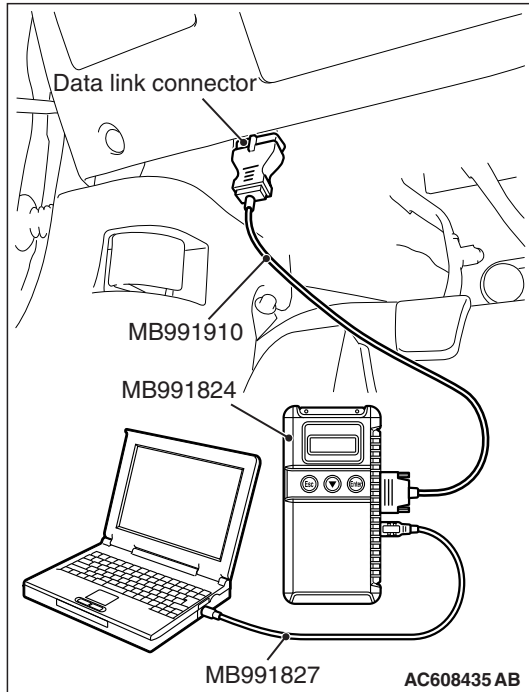

STEP 3. Using scan tool MB991958, read the actuator test.

⚠ CAUTION

To prevent damage to scan tool MB991958, always turn the ignition switch to the "LOCK" (OFF) position before connecting or disconnecting scan tool MB991958.

- (1) Connect scan tool MB991958. Refer to "How to connect scan tool (M.U.T.-III) P.42B-9."
- (2) Turn the ignition switch to the "ON" position.
- (3) Check that the outer tone alarm sounds (Refer to P.42B-151).
- (4) Turn the ignition switch to the "LOCK" (OFF) position.

Q: Is the DTC set?

- YES** : Go to Step 6.
NO : Go to Step 4.

STEP 4. Check KOS-ECU connector C-05 and outer tone alarm connector F-21 for loose, corroded or damaged terminals, or terminals pushed back in the connector.

Q: Are KOS-ECU connector C-05 and outer tone alarm connector F-21 in good condition?

- YES** : Go to Step 5.
NO : Repair or replace the damaged component(s). Refer to GROUP 00E, Harness Connector Inspection P.00E-2. Check that the outer tone alarm works normally.

STEP 5. Check the wiring harness between KOS-ECU connector C-05 (terminal Nos. 35 and 37) and outer tone alarm connector F-21 (terminal Nos. 1 and 2).

- Check the power supply and ground lines for open circuit.

NOTE: Also check intermediate connectors C-42, D-17 for loose, corroded, or damaged terminals, or terminals pushed back in the connector. If intermediate connectors C-42, D-17 is damaged, repair or replace the damaged component(s) as described in GROUP 00E, Harness Connector Inspection P.00E-2.

Q: Are the wiring harness between KOS-ECU connector C-05 (terminal Nos. 35 and 37) and outer tone alarm connector F-21 (terminal Nos. 1 and 2) in good condition?

YES : Go to Step 6.

NO : The wiring harness may be damaged or the connector(s) may have loose, corroded or damaged terminals, or terminals pushed back in the connector. Repair the wiring harness as necessary. Check that the outer tone alarm works normally.

STEP 6. Check of the troubles

Check that the outer tone alarm sounds when the outer tone alarm sounding conditions are met.

Q: Is the check result normal?

YES : The diagnosis is complete.

NO : Replace KOS-ECU and register the ID codes (Refer to P.42B-11).

Inspection Procedure 19: Power door locks with selective unlocking does not work.

⚠ CAUTION

Before replacing the ECU, ensure that the power supply circuit, the ground circuit and the communication circuit are normal.

COMMENT ON TROUBLE SYMPTOM

If the keyless entry function works normally and only the power door locks with selective unlocking does not work normally, ETACS-ECU may be defective. In addition, it is possible that the function has been disabled by using the customization function.

PROBABLE CAUSES

- Malfunction of ETACS-ECU
- Damaged wiring harness and connectors

DIAGNOSIS PROCEDURE

STEP 1. Check the customization

Q: Are the power door locks with selective unlocking enabled by the customization function?

YES : Go to Step 2.

NO : Set the power door locks with selective unlocking to "Enabled" by using the customization function. Refer to [P.42B-238](#).

STEP 2. Keyless entry system operation check

Press the unlock switch of the keyless operation key and check that only the driver's door is unlocked. Then, press the unlock switch once again within 2 seconds after that to check that the front passenger's door and rear doors are unlocked.

Q: Does the keyless entry system work normally?

YES : Go to Step 3.

NO (Only the driver's door is not unlocked.) : Replace ETACS-ECU.

NO (The driver's door, front passenger's door and rear doors are not unlocked.) : Refer to Inspection Procedure 15: "Keyless entry system does not work [P.42B-204](#)."

STEP 3. Check of the troubles

Check that the power door locks with selective unlocking works normally.

Q: Is the check result normal?

YES : Intermittent malfunction (Refer to GROUP 00 –How to Use Troubleshooting/Inspection Service Points –How to Cope with Intermittent Malfunction [P.00-15](#)).

NO : Replace ETACS-ECU.

TERMINAL VOLTAGE REFERENCE CHART

M1429606800232

KOS-ECU TERMINAL CHECK

C-05

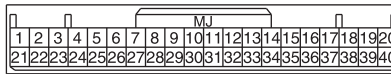

AC507348AJ

Terminal number	Check item	Check condition	Normal condition
1	CAN H	–	–
2	CAN L	–	–
3	–	–	–
4	Steering lock unit signal output	When the ignition switch is operated	0 to 5 V (pulse signal)
5	Steering lock unit power supply	When the ignition switch is operated	5 V
6	Interior transmitter antenna assembly (front) ground	Always	1 V or less
	Interior transmitter antenna assembly (rear) ground		
	Exterior transmitter antenna assembly (driver's side) ground		
	Exterior transmitter antenna assembly (front passenger's side) ground		
	Exterior transmitter antenna assembly (trunk lid) ground		
7	Receiver antenna module power supply	Always	5 V
	Receiver antenna assembly power supply		
8	Push switch inside the steering lock	Push switch inside the steering lock: ON	7 to 8 V
9	Receiver antenna assembly DATA output	Keyless operation key lock button, unlock button, and trunk lid button: ON	0 to 5 V (pulse signal)
	Receiver antenna module signal output		–
10	Receiver antenna module RSSI output	–	–
11	Receiver antenna module signal output	When communicating with the keyless operation key with the emergency key inserted in the inverted direction (ignition switch: ON)	0 to 5 V (pulse signal)

Terminal number	Check item	Check condition	Normal condition
12	Receiver antenna module CLOCK output	<ul style="list-style-type: none"> When communicating with the keyless operation key with the emergency key inserted in the inverted direction (ignition switch: ON) Keyless operation key lock button, unlock button, and trunk lid button: ON 	0 to 5 V (pulse signal)
	Receiver antenna assembly CLOCK output		
13	Receiver antenna module power control	Ignition switch: OFF	0 to 5 V (pulse signal)
	Receiver antenna assembly power control		
14	Ground	Always	1 V or less
15	–	–	–
16	Interior transmitter antenna assembly (front) signal output	When IG push switch is pressed	0 to 5 V (pulse signal) or 0 to 8 V (pulse signal)
17	Exterior transmitter antenna assembly (driver's side) signal output	When the front door outside handle (driver's side) is gripped, or when the lock switch (driver's side) is pressed	0 to 8 V (pulse signal)
18	Exterior transmitter antenna assembly (front passenger's side) signal output	When the front door outside handle (front passenger's) is gripped, or when the lock switch (front passenger's) is pressed	0 to 8 V (pulse signal)
19	Exterior transmitter antenna assembly (trunk lid) signal output	When trunk lid opener switch is pressed	0 to 8 V (pulse signal)
20	Interior transmitter antenna assembly (rear) signal output	When IG push switch is pressed	0 to 5 V (pulse signal) or 0 to 8 V (pulse signal)
21	Lock switch (driver's side) output	Lock switch: ON	1 V or less
22	–	–	–
23	Lock switch (front passenger's side) output	Lock switch: ON	1 V or less
24	Unlock sensor (driver's side) signal output	When the front door outside handle (driver's side) is grasped	1 V or less
25	Unlock sensor (front passenger's side) signal output	When the front door outside handle (front passenger's side) is grasped	1 V or less
26, 27	–	–	–
28	Trunk lid opener switch output	Trunk lid opener switch: ON	1 V or less
29, 30	–	–	–
31	Steering lock unit ground	Always	1 V or less
32	Receiver antenna module ground	Always	1 V or less
	Receiver antenna assembly ground		

Terminal number	Check item	Check condition	Normal condition
33	-	-	-
34	Push switch inside the steering lock power supply	Push switch inside the steering lock: OFF	12V
35	Output to outer tone alarm (-)	Outer tone alarm is sounding	0 to 12 V (pulse signal)
36	Unlock sensor (driver's) power supply	Always	0 to 10 V (pulse signal)
	Unlock sensor (front passenger's side) power supply		
37	Output to outer tone alarm (+)	Outer tone alarm is sounding	0 to 12 V (pulse signal)
38	Battery power supply	Always	Battery positive voltage
39	Power supply from ignition switch (IG1)	Ignition switch: ON	Battery positive voltage
40	Interior transmitter antenna assembly (front) power supply	<ul style="list-style-type: none"> • At the door switch operation • At the ignition switch operation • At door open/close 	5 V
	Interior transmitter antenna assembly (rear) power supply		
	Exterior transmitter antenna assembly (driver's side) power supply		8 V
	Exterior transmitter antenna assembly (front passenger's side) power supply		
	Exterior transmitter antenna assembly (trunk lid) power supply		

ON-VEHICLE SERVICE

ID CODES REGISTRATION PROCEDURES

M1429611700725

REGISTRATION USING SCAN TOOL MB991958 (M.U.T.-III SUB ASSEMBLY)

Required Special Tools:

- MB991958 Scan Tool (M.U.T.-III Sub Assembly)
 - MB991824: Vehicle Communication Interface (V.C.I.)
 - MB991827 M.U.T.-III USB Cable
 - MB991910 M.U.T.-III Main Harness A

By operating the scan tool MB991958 (M.U.T.-III sub assembly) screen, the ID code registration and the TPMS can be registered and antenna communication required to the keyless operation system can be performed. KOS and keyless operation key are indicated as F.A.S.T and F.A.S.T.-key respectively in the scan tool MB991958 (M.U.T.-III sub assembly) screen.

⚠ CAUTION

Do not register the keyless operation key registered for other vehicles.

SUPPLY UNIT LIST FOR INDIVIDUAL KEY

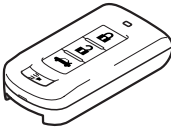
KOS emergency key	KOS key set
 <p data-bbox="321 653 412 674">AC610642</p>	 <p data-bbox="1013 653 1104 674">AC709685</p>

KEY SUPPLY UNIT LIST FOR OTHER THAN INDIVIDUAL KEY

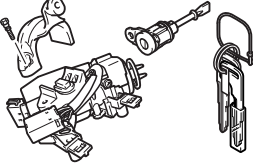
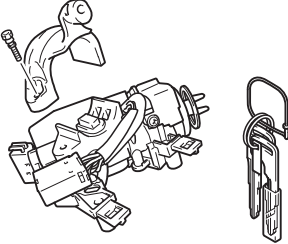
Full service key set	Handle lock service key set
 <p data-bbox="354 1152 444 1173">AC610158</p>	 <p data-bbox="1036 1184 1127 1205">AC610159</p>

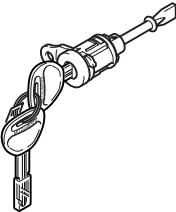
Door service key set <i>NOTE: Key (It can only be used for locking and unlocking, and it cannot start the engine.)</i>
 <p data-bbox="1127 1667 1218 1688">AC610062</p>

NOTE:

- When re-registering the key (key ID), all the keys (key ID) registered before must be re-registered because all of them will be erased.
- After the keyless operation key is registered, start the engine with all the keys and keyless operation keys, and check that KOS operates normally.

Screen flow of scan tool MB991958 (M.U.T.-III sub assembly)

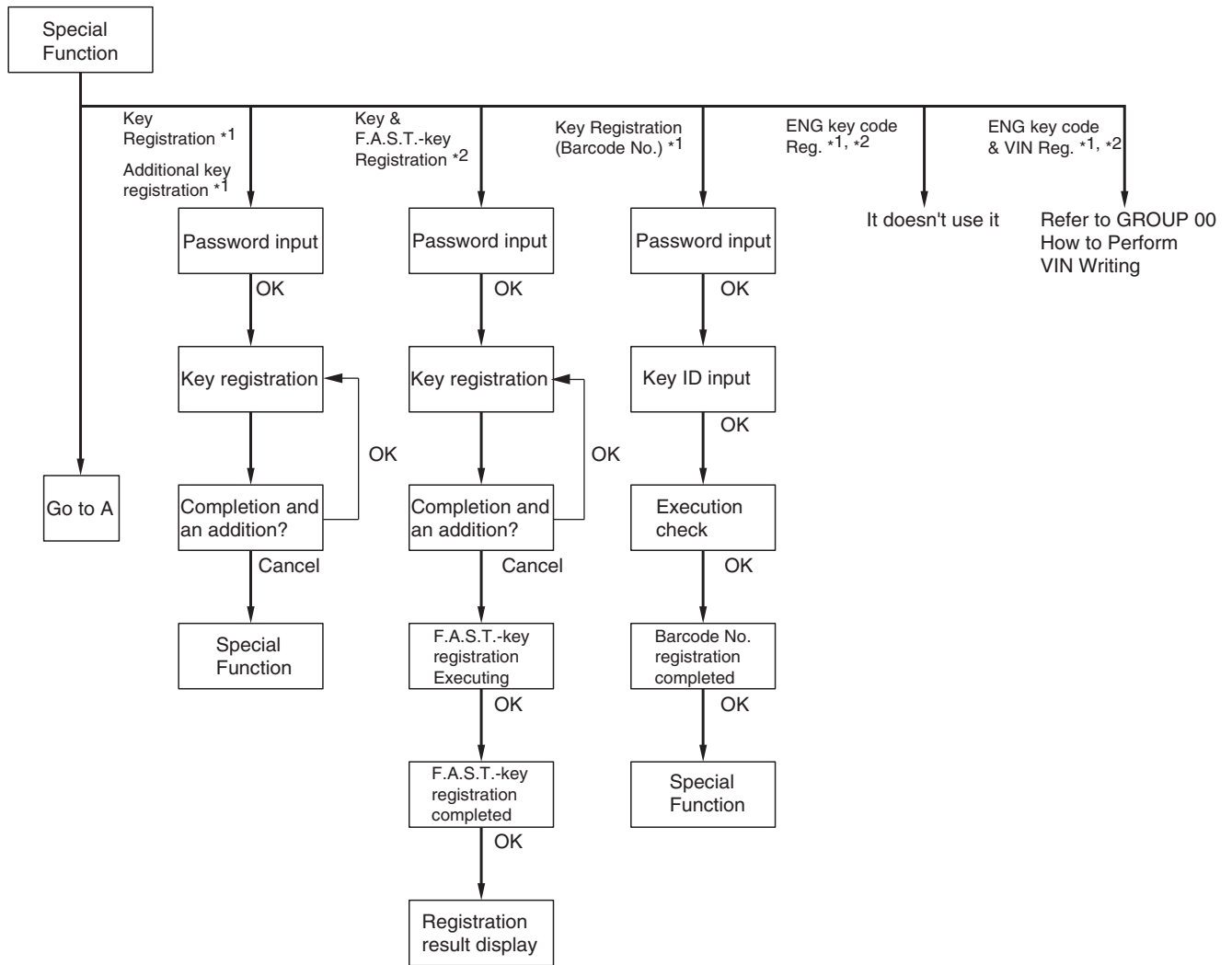

NOTE:

*1 Show the menu displayed when the vehicles for WCM.

*2 Show the menu displayed when the vehicles for KOS.

AC802951AB

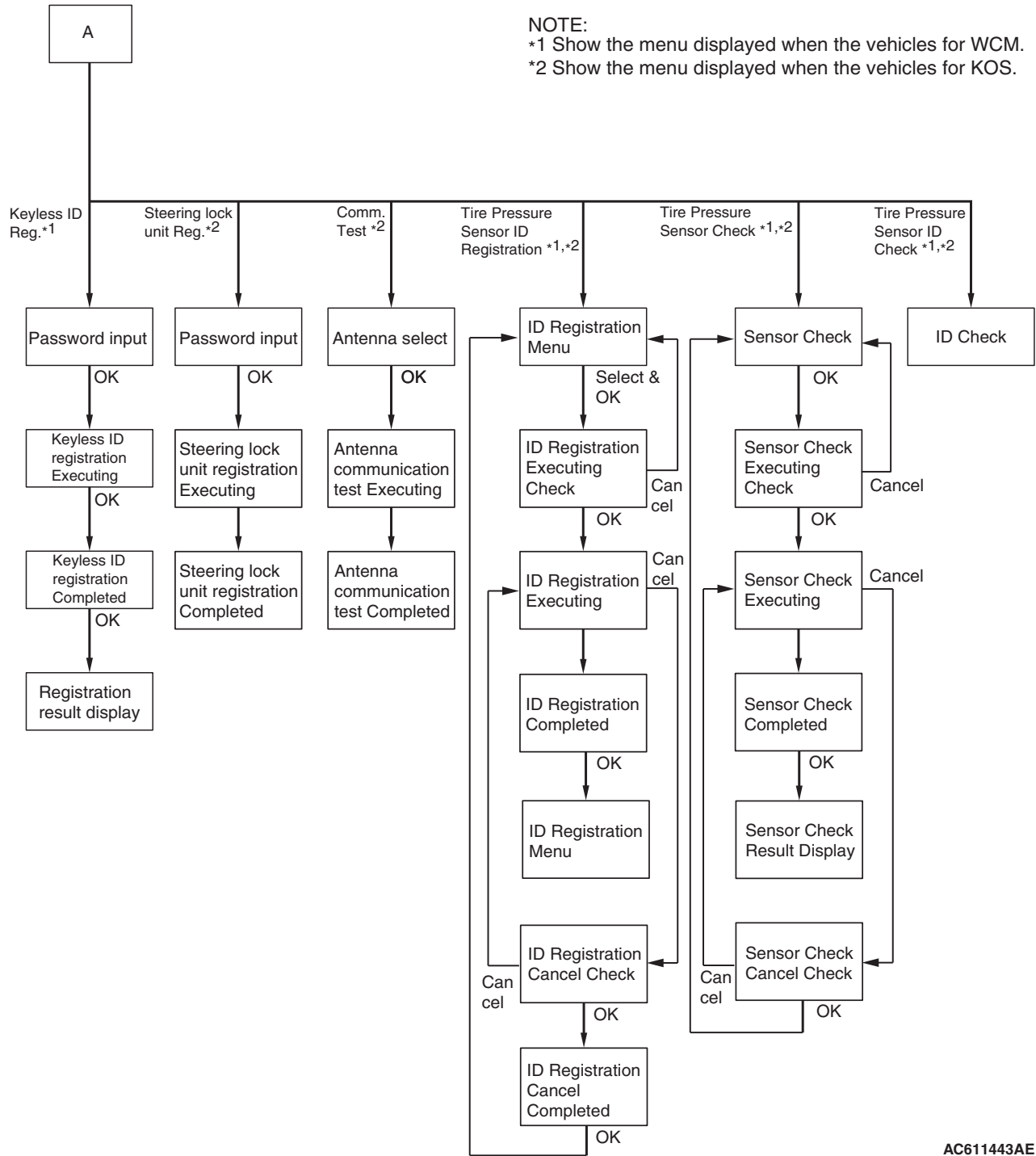

AC611443AE

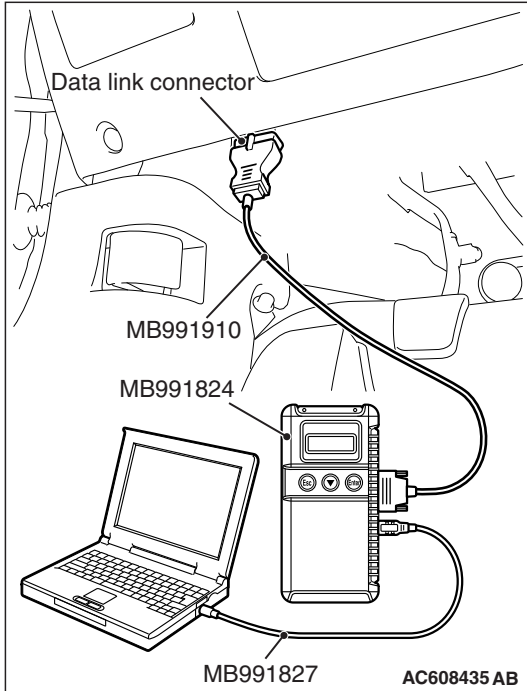

CAUTION

To prevent damage to scan tool MB991958, always turn the ignition switch to the "LOCK" (OFF) position before connecting or disconnecting scan tool MB991958.

Connect the scan tool MB991958 to the 16-pin data link connector as follows.

NOTE: For details on how to use the scan tool, refer to the "M.U.T.-III User's Manual."

1. Start the scan tool MB991958 system on the personal computer and turn the ignition switch to the "ON" position.

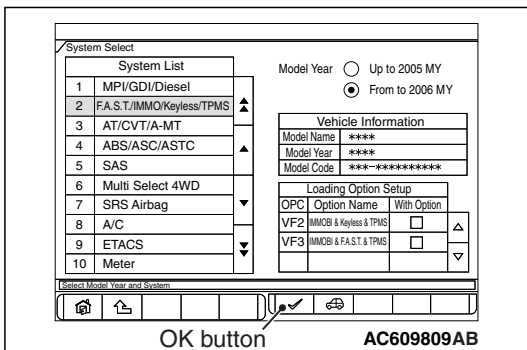

2. Select "F.A.S.T./IMMO/Keyless/TPMS" button from the "System Select" screen. Then, select the applicable option code item and push the OK button.

3. Select "Special Function" on the next screen.

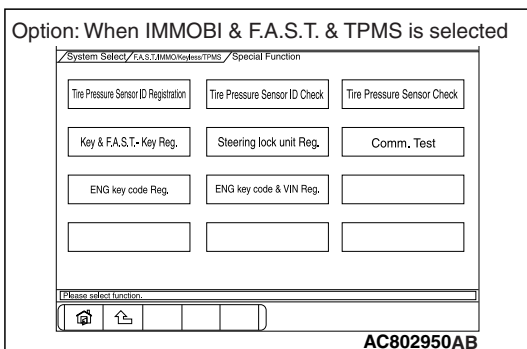

4. Select the button of the operation to be performed from the "Special Function" screen.

- "Tire Pressure Sensor ID Registration": When the TPMS transmitter is replaced and/or the KOS-ECU is replaced.
- "Tire Pressure Sensor Check": When the tire pressure sensor data is checked.
- "Tire Pressure Sensor ID Check": When the tire pressure sensor ID is checked.
- "Key & F.A.S.T. -Key Reg.": When the keyless operation key is lost and/or the KOS-ECU is replaced.
- "Steering lock unit Reg.": When KOS-ECU is replaced but the steering lock assembly is not replaced.
- "Comm. Test": When the KOS antenna communication status is checked.
- "ENG Key Code Reg.": It doesn't use it.
- "ENG Key Code & VIN Reg.": When the engine control module is replaced.

NOTE: For "ENG Key Code & VIN Reg.," refer to GROUP 00 -Precautions before Service P.00-22.

5. After operation check, turn the ignition switch to the "LOCK" (OFF) position.

6. Remove the scan tool MB991958.

"KEY & F.A.S.T. -KEY REG" METHOD

1. When "Key & F.A.S.T. -Key Registration" screen is displayed, enter the password for the key registration and press the OK button. Then, "Executing!" is displayed and the key registration process starts.

NOTE:

- If the wrong password is entered consecutively 5 times, the password entry for the key registration will be disabled for 16 minutes.
- The key registration cannot be cancelled during the operation.

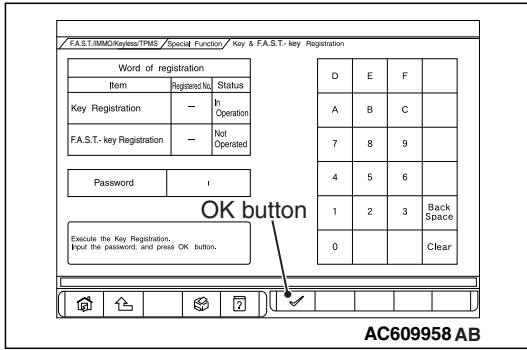

AC609958 AB

2. When the key registration is completed, "Completed." is displayed. To continue the key registration, press the OK button according to the screen instructions. Then "Executing!" is displayed again and the next registration process starts. To finish the key registration and start the keyless operation key registration, press the cancel button. Then "Press OK button to start KOS key registration" is displayed.

NOTE:

- In order to register another key consecutively after registering the first key, the ignition switch must be turned to the ON position with the second key within 30 seconds after turning it to the "LOCK" (OFF) position with the first key. [When turning the ignition switch to the "ON" position or "LOCK" (OFF) position, be sure that the emergency key is connected to the keyless operation key. Do not use the emergency key independently.]
- Up to four keys can be registered.

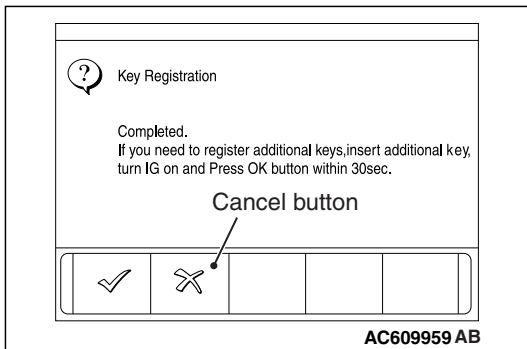

AC609959 AB

3. Press the lock switch of the keyless operation key to be registered twice within 1 minute to allow the keyless operation key to be registered. Complete the registration within 1 minute and press the OK button. Then the keyless operation key registration ends.

NOTE:

- Up to 4 keyless operation keys can be registered.
- Register keyless operation keys inside the vehicle.
- Register the keyless operation keys with the key released from scan tool display.

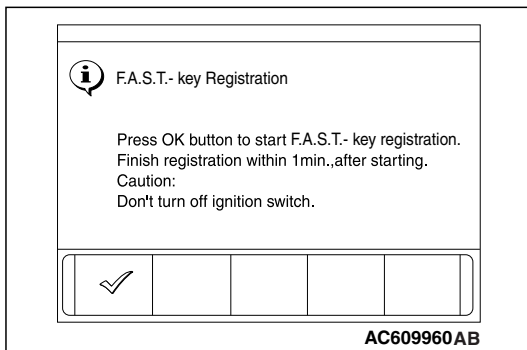

AC609960 AB

4. Push the OK button after "F.A.S.T. -key Registration was finished." is displayed.

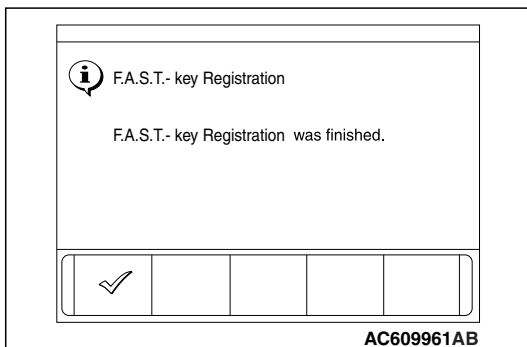

AC609961 AB

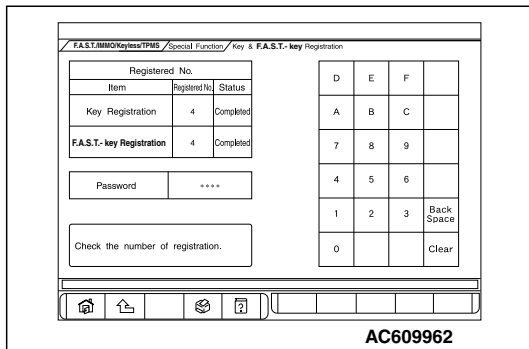

5. Check the number of the registered keys and keyless operation keys.

NOTE: When the key cannot be registered using scan tool MB991958, refer to Inspection Procedure 2 "The keyless operation key cannot be registered using scan tool P.42B-154."

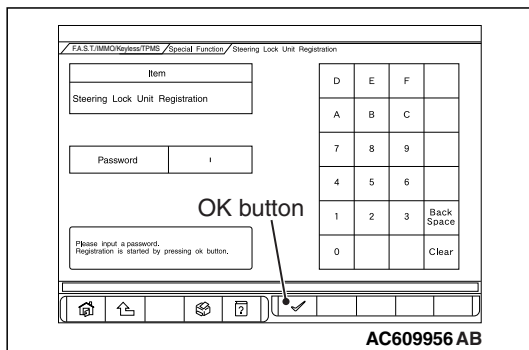

"STEERING LOCK UNIT REG." METHOD

1. Enter the password on "Steering Lock Unit Registration" screen and press the OK button to register the KOS ID.
2. Push the OK button after "Completed." is displayed.

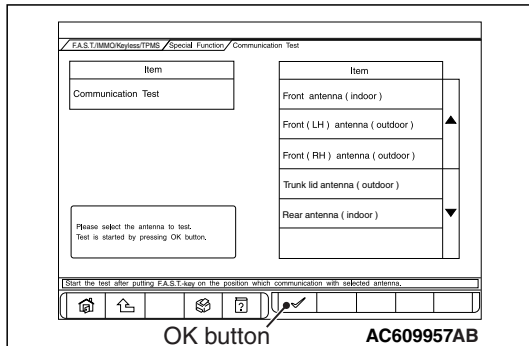

"COMM. TEST" METHOD

1. Select the antenna to be tested on "Communication Test" screen, and press the OK button with the keyless operation key placed within the communication operational area.
2. Push the OK button after "Communication is normal." is displayed.

"TIRE PRESSURE SENSOR ID REGISTRATION" METHOD

1. Select "4tires ID Reg. (Change tire PRS.)" and start the tire pressure sensor ID registration.

CAUTION

Register all tire pressure sensor IDs within twenty minutes.

2. "4 SNSR ID Registration Do you want to start? Note Finish ID Registration within 20 minutes." is displayed. Then, press "OK."

NOTE: If the ID code registration is not finished within 20 minutes, all the ID codes registered in the TPMS transmitter before will be erased. For this reason, the ID codes need to be registered again.

3. Decrease the tire pressure to 174 kPa (25.2 psi) or less by changing 20 kPa (2.9 psi) or more, and register the TPMS transmitter ID code of each wheel to KOS-ECU.

NOTE:

- You can start out the operations from any TPMS transmitter. The tire pressure sensor ID registration has no order.
 - On completion of the TPMS transmitter ID code registration, the TPMS transmitter ID code is displayed on the scan tool screen.
 - Scan tool cannot identify which registered TPMS transmitter is used for each wheel. For this reason, write down the tire number for each wheel when the tire number and ID code is displayed on the scan tool during ID code registration.
 - It may take approximately one minute for the ID code to be displayed on the scan tool screen after the tire pressure is reduced.
 - If the ID code is not displayed, reduce the tire pressure another 20 kPa (2.9 psi) or more. If the ID code is not displayed yet, rotate the tire to displace the TPMS transmitter, and reduce the tire pressure 20 kPa (2.9 psi) or more again.
 - If the ID code cannot be registered for all the four wheels, the KOS-ECU may be faulty, thus replace the KOS-ECU.
 - If the ID code can be registered for one wheel or more, the TPMS transmitter in which the code cannot be registered may be faulty, thus replace that TPMS transmitter.
4. "4 SNSR ID Registration Completed." is displayed. Then, select "OK."

NOTE: The TPMS indicator illuminates for tire pressure alarm.

5. After one minute or more has passed, correct the tire pressure for all wheels with ignition switch "ON".
6. Check the data list "Registered ID reception, Tire 1, 2, 3, 4" if "YES" is displayed for each tire. When "NO" is displayed, drive the vehicle for approximately 5 minutes, check the display again. If "NO" is still displayed, register the ID code again.

"TPMS TRANSMITTER CHECK" METHOD

According to the following procedures, identify which registered TPMS transmitter corresponds to which wheel, and check the tire pressure and acceleration value of each TPMS transmitter.

1. Check the data list "Air Pressure, Tire1, 2, 3, 4" and write down the tire pressure for all wheels.

NOTE: The display at this time is the data received most recently.

2. Perform the following procedures for four wheels in order, identify the wheel by checking the tire pressure of each wheel.

- (1) Change the pressure of tire for 20 kPa (2.9 psi) or more so that the TPMS transmitter sends the latest sensor data (The tire pressure can either be decreased or increased).
- (2) Check the data list screen to determine which tire number corresponds to the wheel whose tire pressure has changed.

NOTE:

- *It may take approximately one minute that the data of tire pressure change is displayed on the scan tool screen.*
- *If the data of tire pressure change is not displayed on the scan tool screen, the most possible cause is that the radio wave sent from the TPMS transmitter cannot be received. In this case, the radio wave may be received by performing the procedures from (1) again after turning the tire to change the TPMS transmitter position. If the tire pressure change is still not displayed on the scan tool screen, the TPMS transmitter in which the ID code is not registered may be installed, or the TPMS transmitter may be faulty. Therefore, perform ID code registration or replace the TPMS transmitter according to the instructions of troubleshooting for DTCs. (At this time, do not register the ID codes or replace the TPMS transmitter.)*

3. Check the tire pressure or acceleration value shown in the screen (if needed).
4. After checking by the tire pressure change, adjust the checked tire pressure to the proper value.

"TIRE PRESSURE SENSOR ID CHECK" METHOD

1. Select "Tire Pressure Sensor ID Check".
2. Check the registered TPMS transmitter IDs on the scan tool screen.

**REGISTRATION NOT USING SCAN TOOL
MB991958 (M.U.T.-III SUB ASSEMBLY) <USA
ONLY>**

When the keyless operation key is lost or additional keys are requested, the emergency key and the keyless operation key must be used to register key ID.

 CAUTION

Two keyless operation keys that have been registered are needed.

1. Turn the ignition switch to the "ON" position using the registered emergency key and keyless operation key.
2. After turning the ignition switch to "ON," press and hold the UNLOCK button of the first registered keyless operation key for 4 to 10 seconds, and press the LOCK button during that time.

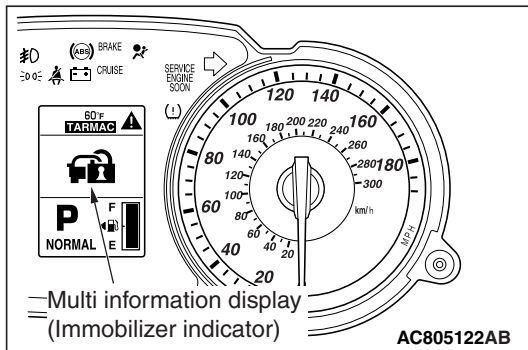

3. Within 10 seconds after pressing the LOCK button in Step 2, release the LOCK button and then UNLOCK button. (Perform within 30 seconds after completion of Step 1.)
4. Then, press and hold the UNLOCK button of the second registered keyless operation key for 4 to 10 seconds, and press the LOCK button during that time.
5. Within 10 seconds after pressing the LOCK button in Step 4, release the LOCK button and then UNLOCK button. (Perform within 30 seconds after completion of Step 3.)
6. The immobilizer indicator starts flashing, and the mode shifts to the keyless operation key additional registration mode.
7. Check that the immobilizer indicator flashes, and press the LOCK button of unregistered keyless operation key twice. KOS starts registration communication with the keyless operation key.
8. After the additional registration of keyless operation key is completed, the data is recorded to EEPROM, and when the data recording is completed, the immobilizer indicator flashes for 30 seconds.
9. When a new keyless operation key is additionally registered, repeat Steps 1 to 8 after the ignition switch is turned to "LOCK" (OFF).
10. The keyless operation key addition is terminated if any of the following conditions is met.
 - The additional registration of keyless operation key was completed.
 - The signal of LOCK button operation was received from the keyless operation key which was registered in Step 8.
 - Within 60 seconds after shift to the keyless operation key additional registration mode, the operation in Step 8 does not complete.
 - Before the registration communication with unregistered keyless operation key starts, the ignition switch was turned to "LOCK" (OFF).
 - The registration communication failed.
 - The recording to EEPROM failed.

ANTENNA COMMUNICATION TEST

M1429606400063

Refer to ID codes registration procedure [P.42B-227](#).

TPMS TRANSMITTER CHECK

M1429614500021

Refer to ID codes registration procedure [P.42B-227](#).

TPMS TRANSMITTER ID CHECK

M1429614600028

Refer to ID codes registration procedure [P.42B-227](#).

KEYLESS ENTRY SYSTEM CHECK

M1429611800034

Check the keyless entry system as described below. If it does not work, perform troubleshooting (Refer to [P.42B-152](#)).

- Operate the keyless operation key to check that the doors can be locked and unlocked.
- Operate the keyless operation key to check that the answerback function works in response to door locking/unlocking.

NOTE: The hazard answerback setting can be changed using the customization function. Confirm which setting is activated before performing these checks (Refer to [P.42B-238](#)).

INSPECTION OF KEYLESS ENTRY TIMER LOCK FUNCTION

M1429612200035

Attempt to unlock the doors by using the keyless operation key. If the doors is not locked within 30 seconds, carry out diagnosis. Note that the doors will not be locked if the ignition key is inserted within the 30-second period, one of the doors is opened (Refer to [P.42B-152](#)).

NOTE: The operation time of the keyless entry timer lock function can be set using the customisation function. Confirm the operation time before performing the diagnosis (Refer to [P.42B-238](#)).

POWER DOOR LOCKS WITH SELECTIVE UNLOCKING INSPECTION

M1429619600023

Press the unlock switch on the keyless operation key once to unlock only the driver's door. Press the unlock switch of the keyless operation key once again within 2 seconds after the driver's door is unlocked, and check that the front passenger's door and the rear doors are unlocked. If they are not unlocked, carry out troubleshooting. Refer to [P.42B-152](#).

NOTE: Press the unlock switch on the keyless operation key once to unlock only the driver's door. When the unlock switch of the keyless operation key is pressed once again more than 2 seconds after the driver's door is unlocked, only the driver's door is unlocked.

NOTE: The setting of the power door locks with selective unlocking can be changed using the customization function. Confirm which setting is activated before performing these checks. Refer to [P.42B-238](#).

CUSTOMIZATION FUNCTION

By operating the ETACS system or MMCS of scan tool MB991958, the following functions can be programmed. The programmed information is held even when the battery is disconnected.

Adjustment item (scan tool MB991958 display)	Adjustment item	Adjusting contents (scan tool MB991958 display)	Adjusting contents
Hazard answer back	Adjustment of the number of keyless hazard warning light answer back flashes	Lock:1, Unlock:2	LOCK: Flashes once, UNLOCK: Flashes twice (initial condition)
		Lock:1, Unlock:0	LOCK: Flashes once, UNLOCK: No flash
		Lock:0, Unlock:2	LOCK: No flash, UNLOCK: Flash twice
		Lock:2, Unlock:1	LOCK: Flash twice, UNLOCK: Flash once
		Lock:2, Unlock:0	LOCK: Flash twice, UNLOCK: No flash
		Lock:0, Unlock:1	LOCK: No flash, UNLOCK: Flash once
		Lock:0, Unlock:0	No function
Dome light delay timer with door	Adjustment of interior light delay shutdown time	0 sec	0 second (no delay shutdown time)
		7.5 sec	7.5 seconds
		15 sec	15 seconds
		30 sec	30 seconds (initial condition)
		60 sec	60 seconds
		120 sec	120 seconds
		180 sec	180 seconds
Door unlock mode	Adjustment of power door locks with selective unlocking	All doors unlock	Without function: The first operation of keyless entry system or unlock operation by KOS unlocks all doors.
		Dr door unlock	With function: The first operation of keyless entry system or unlock operation by KOS unlocks the driver's door only, and the second unlock operation within 2 seconds after that unlocks all doors. (initial condition)

Adjustment item (scan tool MB991958 display)	Adjustment item	Adjusting contents (scan tool MB991958 display)	Adjusting contents
Auto door unlock	Adjustment of the auto door unlock function	Disabled	Without function (initial condition) <M/T, TC-SST>
		Always (P pos)	With function: Operates when the shift lever or the selector lever is moved to the P position. <TC-SST>
		P/W unlock (P)	With function: Operates when the shift lever or the selector lever is moved to the P position with the power window lock switch in the OFF position. <TC-SST>
		Always(Lock pos)	With function: Operates when the ignition switch is moved to the LOCK (OFF) position. <M/T, TC-SST>
		P/W unlock(Lock)	With function: Operates when the ignition switch is turned to the LOCK (OFF) position with the power window lock switch in the OFF position. <M/T, TC-SST>
Duration of horn chirp	Horn sounding time during horn answer back	Short	0.01 second (initial condition)
		Long	0.02 second
Horn chirp by keyless	Horn chirp by keyless entry system <vehicles without auto light>	Not sound horn	No horn answerback function
		Lock any time	The horn sounds when the lock button of keyless entry transmitter is pressed once.
		W lock any time	The horn sounds when the lock button of keyless entry transmitter is pressed twice. (initial condition)
	Horn chirp by keyless entry system <vehicles with auto light>	Not sound horn	No horn answerback function
		Lock any time	The horn sounds when the lock button of keyless entry transmitter is pressed once.
		Lock/auto ON	During daytime, while the lighting switch is in the AUTO position, the horn sounds once when the lock is pressed once.
		W lock any time	The horn sounds when the lock button of keyless entry transmitter is pressed twice. (initial condition)
	Tone alarm answer back	Adjusts the tone alarm answer back function	Not sound buzzer
At keyless			Sounds when the keyless entry system is activated.
At F.A.S.T.			Sounds when KOS is activated (initial condition).
At Both			Sounds when the keyless entry system or KOS is activated.

Adjustment item (scan tool MB991958 display)	Adjustment item	Adjusting contents (scan tool MB991958 display)	Adjusting contents
Timer lock timer	Timer lock period adjustment	30 sec	30 seconds (initial condition)
		60 sec	60 seconds
		120 sec	120 seconds
		180 sec	180 seconds
Panic alarm switch	With/without panic alarm function	Disable	No function
		Enable	With function (initial condition)
F.A.S.T. key detect out fm window	With/without KOS key exterior detection function	Enable	No function
		Disable	With function (initial condition)
F.A.S.T. feature	KOS function adjustment	Both enable	All KOS functions are enabled (initial condition).
		DoorEntry enable	Only door entry function is enabled.
		ENG strt enable	Only engine starting function is enabled.
		Both disabled	All KOS functions are disabled.
F.A.S.T. unlock disable time	Adjusts the door unlock inhibition period after door lock is activated	0 sec	0 second
		3 sec	3 seconds (initial condition)
		5 sec	5 seconds

KOS-ECU

REMOVAL AND INSTALLATION

M1429605900203

⚠ WARNING

When removing and installing the KOS-ECU, do not let it bump against the knee air bag module.

⚠ CAUTION

If KOS-ECU is replaced, refer to ID code registration need judgment table [P.42B-11](#) to complete the registration of each ID code.

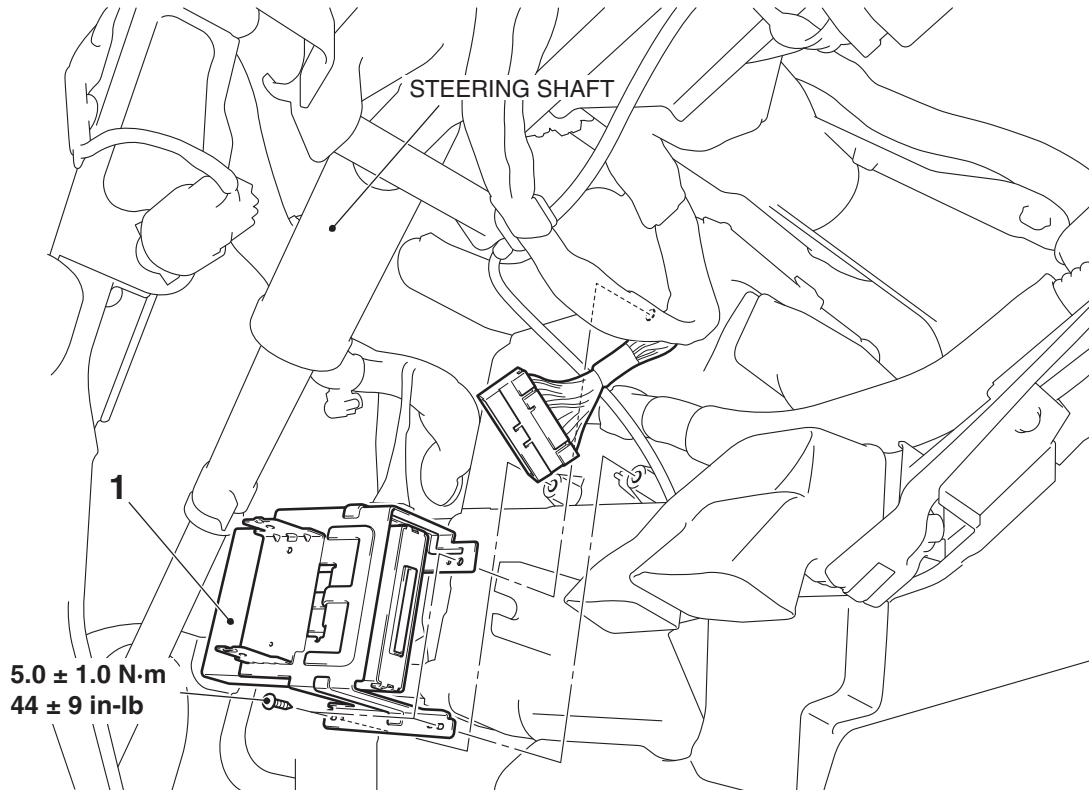

AC607425AB

Removal

1. KOS-ECU

EXTERIOR TRANSMITTER ANTENNA ASSEMBLY, INTERIOR TRANSMITTER ANTENNA ASSEMBLY, RECEIVER ANTENNA MODULE

REMOVAL AND INSTALLATION

M1429606200263

<EXTERIOR TRANSMITTER ANTENNA ASSEMBLY, INTERIOR TRANSMITTER ANTENNA ASSEMBLY AND TONE ALARM ASSEMBLY>

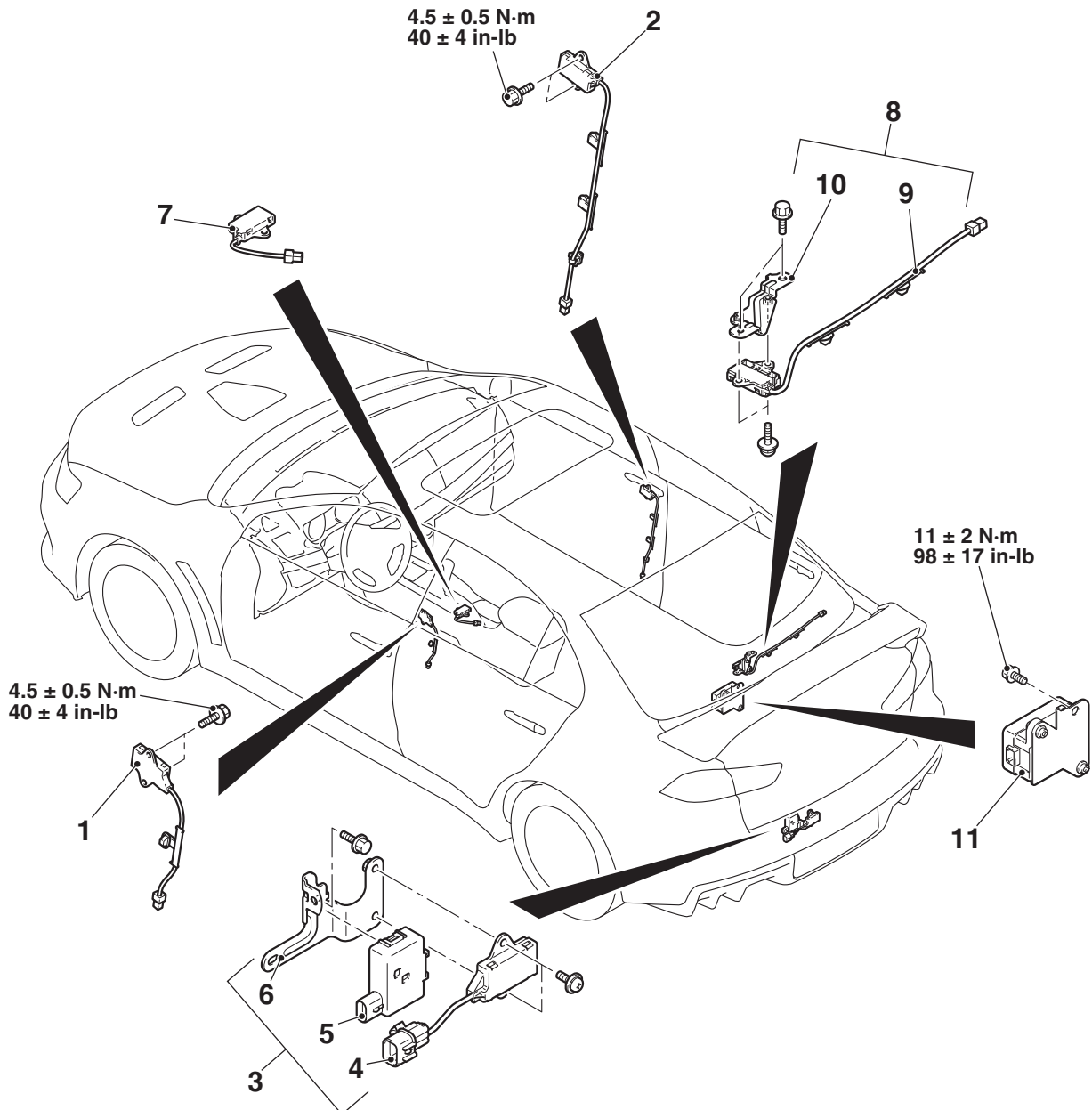

AC708899AB

Exterior transmitter antenna assembly (driver's side) removal steps

- Center pillar trim upper <LH> (Refer to GROUP 52A –Interior Trim [P.52A-12.](#))
- Exterior transmitter antenna assembly (driver's side)

Exterior transmitter antenna assembly (front passenger's side) removal steps

- Center pillar trim upper <RH> (Refer to GROUP 52A –Interior Trim [P.52A-12.](#))
- Exterior transmitter antenna assembly (front passenger's side)

Antenna and tone alarm**assembly removal steps**

- Rear bumper assembly (Refer to GROUP 51 –Rear Bumper Assembly [P.51-6.](#))
- 3. Antenna and tone alarm assembly
- 4. Exterior transmitter antenna assembly (trunk lid)
- 5. Tone alarm
- 6. Bracket

Interior transmitter antenna**assembly (front) removal steps**

- Floor console box cup holder assembly (Refer to GROUP 52A – Floor Console Assembly [P.52A-10.](#))
- 7. Interior transmitter antenna assembly (front)

Interior transmitter antenna**assembly (rear) and bracket****removal steps**

- Rear shelf trim (Refer to GROUP 52A –Interior Trim [P.52A-12.](#))
- 8. Interior transmitter antenna assembly (rear) and bracket
- 9. Interior transmitter antenna assembly (rear)
- 10. Bracket

Receiver antenna assembly**removal steps**

- Trunk room trim front (Refer to GROUP 52A, Interior trim [P.52A-12](#))
- 11. Receiver antenna assembly

<RECEIVER ANTENNA MODULE>

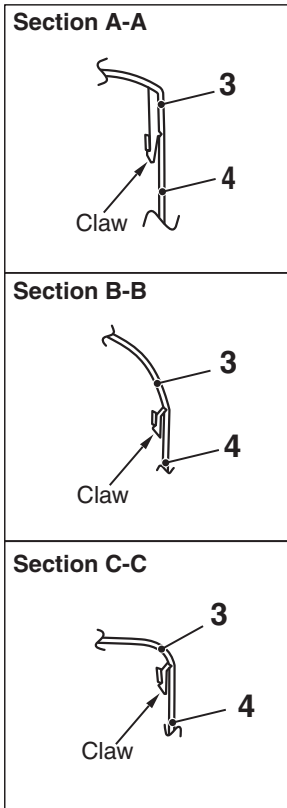

NOTE: Claw position is symmetrical

Receiver antenna module removal

- >>A<<
1. IG knob cap
 2. Ignition key cover
 3. Steering column upper cover
 4. Steering column lower cover
 5. Receiver antenna module

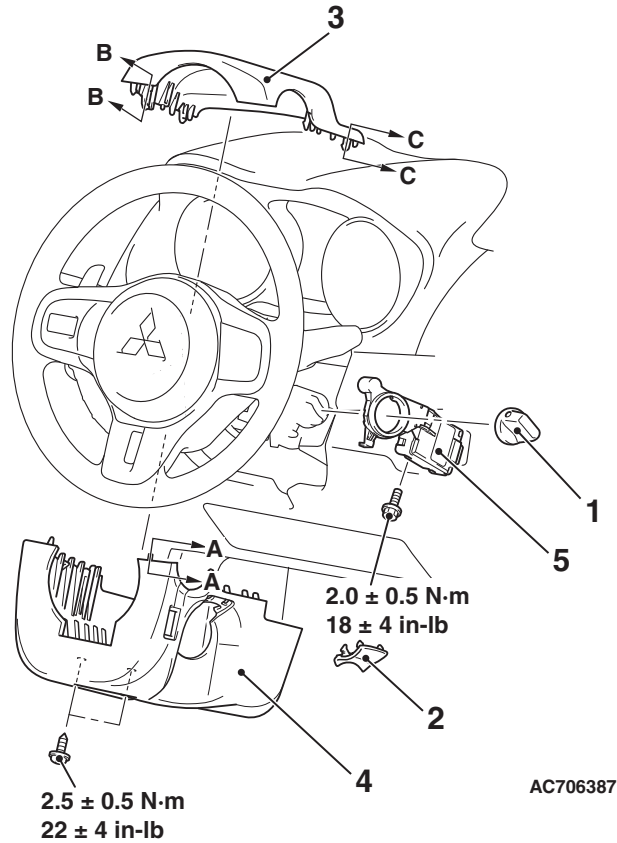

INSTALLATION SERVICE POINT

>>A<< RECEIVER ANTENNA MODULE INSTALLATION

Check that the top claw of receiver antenna module is fixed securely to the boss of steering lock and the antenna is not floated on the key cylinder.

KEYLESS OPERATION KEY

DISASSEMBLY AND ASSEMBLY

M1429604000188

Post-installation operation

Operation check of the keyless operation key

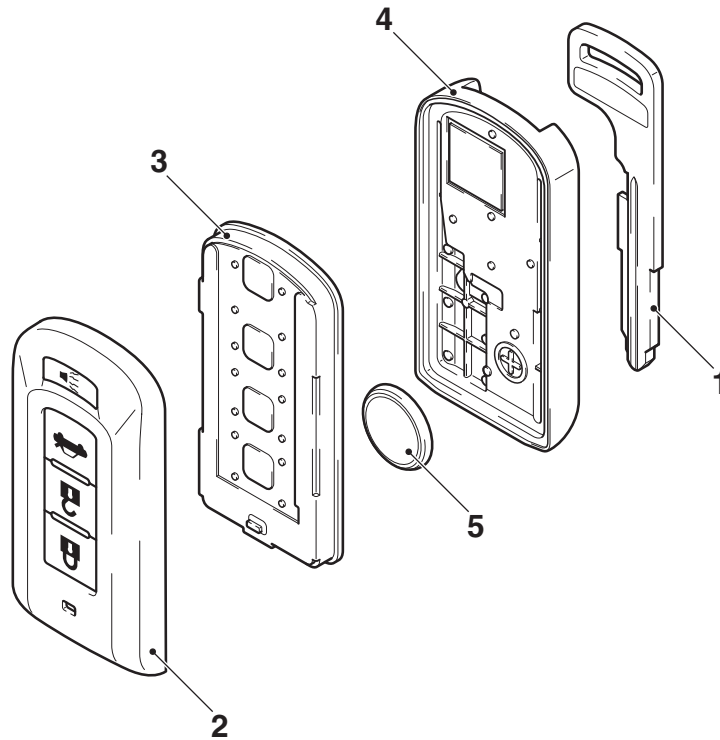

AC609035 AG

<<A>>

Disassembly steps

1. Emergency key
2. Upper cover
3. Transmitter assembly

<>

Disassembly steps (Continued)

- >>A<< 4. Lower cover
5. Battery

DISASSEMBLY SERVICE POINTS

<<A>> EMERGENCY KEY REMOVAL

With the lever being pressed in the arrow direction of the illustration, pull out the emergency key from the keyless operation key and remove it.

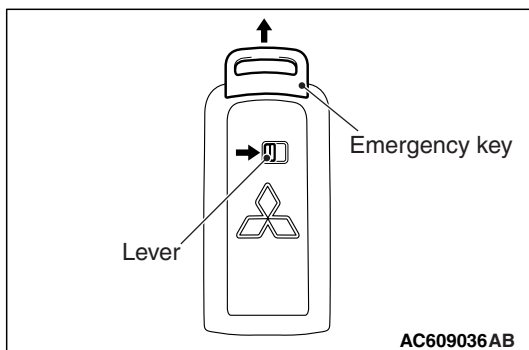

<> UPPER COVER REMOVAL

 CAUTION

Do not allow water or dust to enter the inside of the transmitter assembly when it is open. Also, do not touch the precision electronic device.

Place a flat-tipped screwdriver wrapped with protective tape as shown in the figure, and lever the keyless operation key to remove.

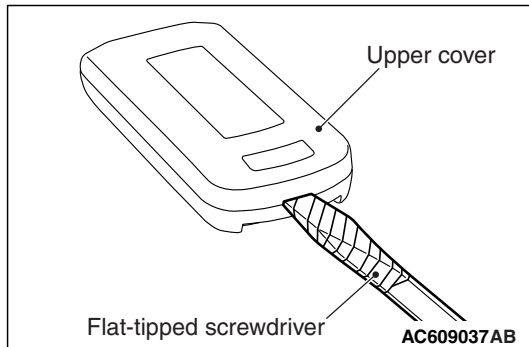

ASSEMBLY SERVICE POINT

>>A<< BATTERY INSTALLATION

 CAUTION

Do not allow water or dust to enter the inside of the transmitter assembly when it is open. Also, do not touch the precision electronic device.

Install a new battery with the positive side facing toward the lower cover.

**Replacement battery: Coin-type lithium battery
CR2032**

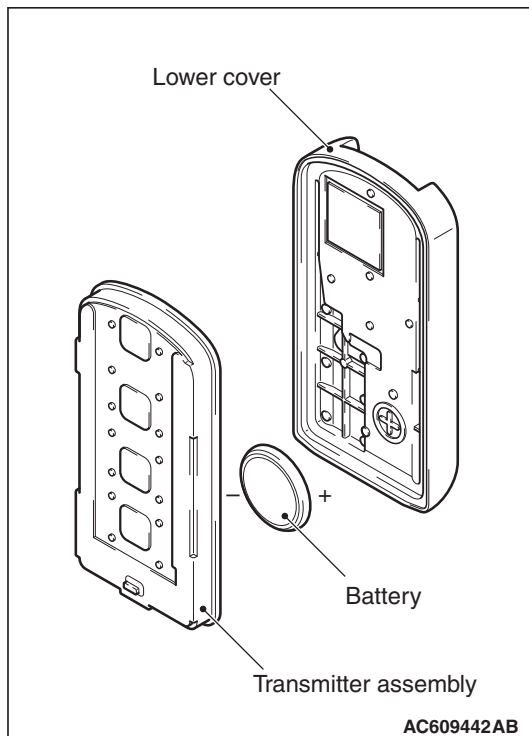

TPMS TRANSMITTER

REMOVAL AND INSTALLATION

M1429613000012

WARNING

Certain components of this vehicles, such as TPMS transmitters, may contain perchlorate materials. Special handling may apply. For additional information, see www.dtsc.ca.gov/hazardouswaste/perchlorate.

CAUTION

- Do not vary the angle of valve except at mounting on the rim. If varying the angle over and over, it may cause breakage of antenna plate resulting in the failure of TPMS transmitter.
- Ensure valve cap is always in place except when adjusting tire pressure.
- If the valve core and valve cap are replaced, use a genuine replacement part. The valve core is similar to a conventional one, but uses nickel plating to avoid corrosion.
- Replace the seal and seal washer with a new one every five years or when the tire is replaced.
- Do not drop the TPMS transmitter from height greater than 1 meter (3.3 feet).
- Do not expose the TPMS transmitter to extraneous magnetic fields.
- TPMS transmitter should not be stored at temperatures above 80° C (176° F).
- TPMS transmitter should not be exposed to temperatures above 100° C (212° F).
- If the TPMS transmitter is replaced, execute "Tire Pressure Sensor ID Registration" on scan tool MB991958 "Special Function."
- Be careful not to damage the TPMS transmitter.

Pre-removal Operation

- Wheel and Tire Removal

Post-installation Operation

- Wheel and Tire Installation
- Tire Pressure Sensor ID Registration If a new TPMS transmitter is installed (Refer to [P.42B-11](#)).
- After the tire pressure sensor ID registration, check that the TPMS warning light does not illuminate or flash.

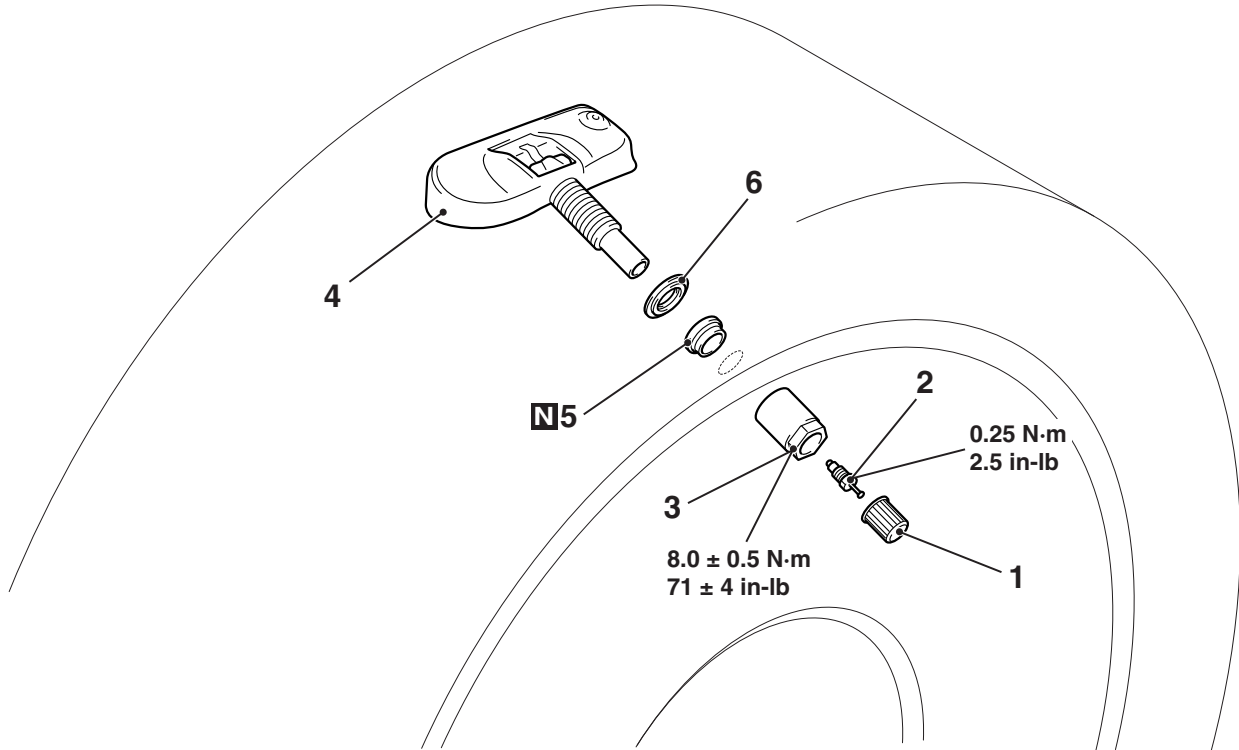

AC610443AB

<<A>>
<<A>>
<<A>>

- Removal steps**
1. Cap
 2. Valve core
 3. Nut
 - Let TPMS transmitter fall into tire
 - Tire bead
 4. TPMS transmitter
 5. Seal
 6. Seal washer

<>
<<C>>
<<C>>

>>A<<
>>A<<
>>A<<
>>A<<
>>B<<

>>C<<
>>C<<

- Installation steps**
6. Seal washer
 5. Seal
 4. TPMS transmitter
 3. Nut
 - Tire bead mounting
 2. Valve core
 - Tire pressure inflation
 - Valve nut retightening
 1. Cap

REMOVAL SERVICE POINTS

<<A>> CAP/VALVE CORE/NUT REMOVAL

⚠ CAUTION

Ensure cap is always in place except when adjusting tire pressure.

1. Remove the cap and valve core to deflate the tire.
2. Once tire pressure is released, remove nut and let TPMS transmitter fall into tire.

<> TPMS TRANSMITTER REMOVAL

CAUTION

Be careful not to damage the TPMS transmitter.

1. Place on tire changing machine and break both tire beads ensuring that the TPMS transmitter remains in the bottom of the tire.
2. Lubricate tire well and remove outer side of the tire.
3. Reach inside the tire and remove the TPMS transmitter.
4. Remove tire from rim using proper tire changing equipment procedures.

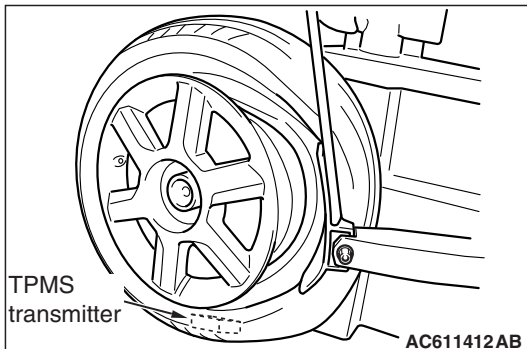

<<C>> SEAL/SEAL WASHER REMOVAL

CAUTION

- Do not vary the angle of valve except at mounting on the rim. If varying the angle over and over, it may cause breakage of antenna plate resulting in the failure of TPMS transmitter.
- Use a soft tool to remove the grommet and washer to prevent scratching the valve of the TPMS transmitter.

1. Hold the TPMS transmitter and the seal washer, then extract it, this also extracts the seal. Take care to not damage the valve thread.

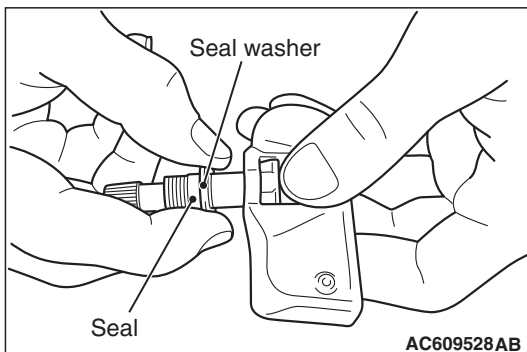

2. Clean the TPMS transmitter and the valve stem holding the valve as shown. Take care to support the rear of the valve with a thumb so that there is no movement of the stem.

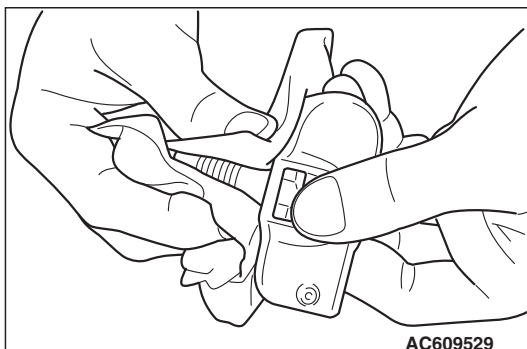

INSTALLATION SERVICE POINTS

>>A<< SEAL/SEAL WASHER/TPMS TRANSMITTER/NUT INSTALLATION

⚠ CAUTION

When installing a new seal and seal washer, make sure to support the valve stem base with a thumb so that there is no movement of the stem. Otherwise, the stem may protrude resulting in the breakage of antenna plate.

1. Insert these up to the base of the TPMS transmitter, making sure to secure the valve base with a thumb, as shown.
Wipe the seal and threading.

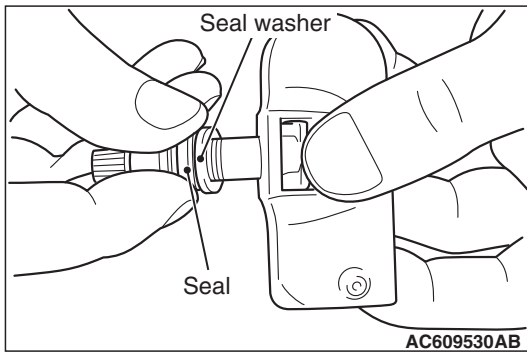
**⚠ CAUTION**

- Visually check that TPMS transmitter is not deformed or damaged.
 - When installing the TPMS transmitter, be sure the rim, seal valve and nut are clean.
 - Ensure the grommet is located inside the valve hole before installing the nut.
 - While installing the nut, push the TPMS transmitter to maintain the lower lip of the transmitter case is in contact with the rim without clearance.
 - While installing the valve nut, ensure the tool is kept aligned to the valve and the valve hole.
 - After installing the nut, check that the seal is compressed and seal washer is bend.
2. Install the valve, in the valve hole, without modifying the angle of the stem (retain position of delivery). The laser marking should be visible at the operator.

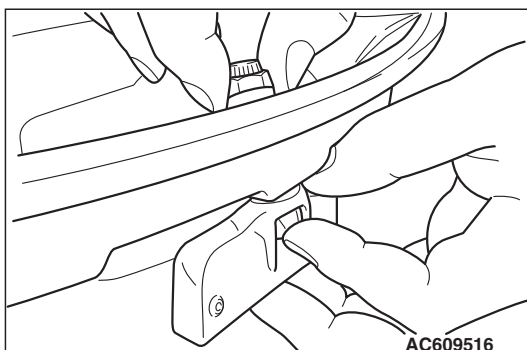
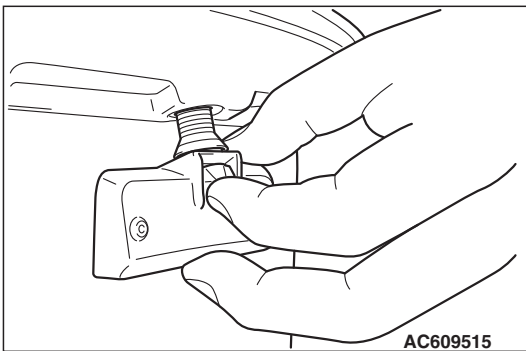

3. When the valve is completely inserted, maintain the TPMS transmitter in contact with the rim, then screw manually the nut until the contact with the wheel.

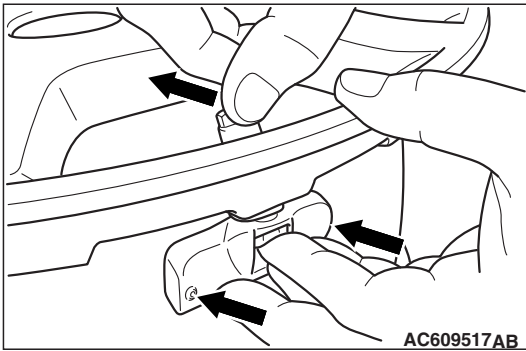

4. While maintaining the TPMS transmitter contact with the rim by applying pressure to the back of the valve, slightly press on the cap to wards the center of the wheel in order to adapt the angle of the valve/TPMS transmitter to the profile of the rim.

It is mandatory to guarantee the contact of the housing unit on the rim drop center.

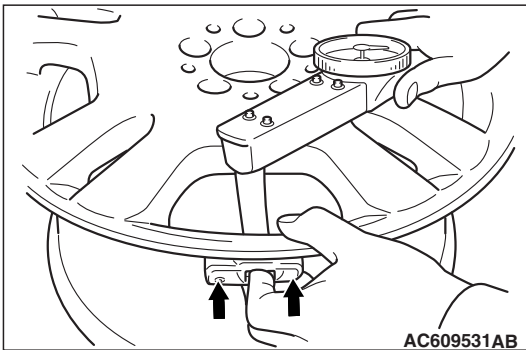

5. While maintaining the TPMS transmitter and valve in position, screw the nut with a torque wrench. Take care that the wrench socket is correctly inserted on the nut.

Specified torque: $8.0 \pm 0.5 \text{ N} \cdot \text{m}$ ($71 \pm 4 \text{ in-lb}$)

>>B<< TIRE BEAD MOUNTING

1. Prepare the tire and fix the rim as usual.

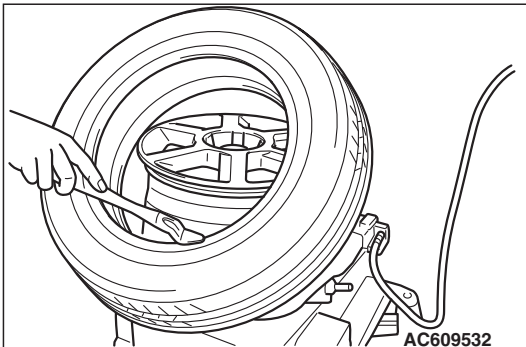

2. Put the tire on the rim, so that the cross point of the belt with the rim is approximately 20 cm (7.9 inch) away from the valve.

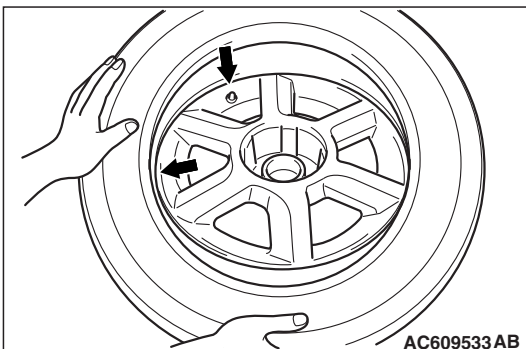

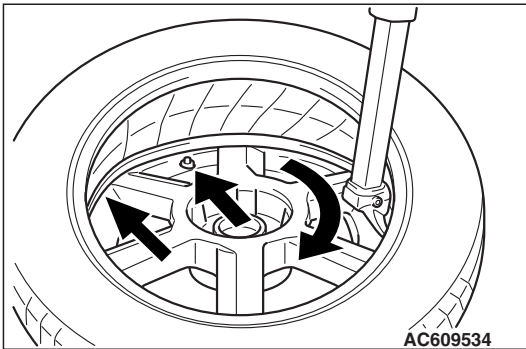

- Engage the shoe and make sure that 20 cm (7.9 inch) is maintained between the cross point and the valve. The arrow shows the direction of rotation of the wheel.

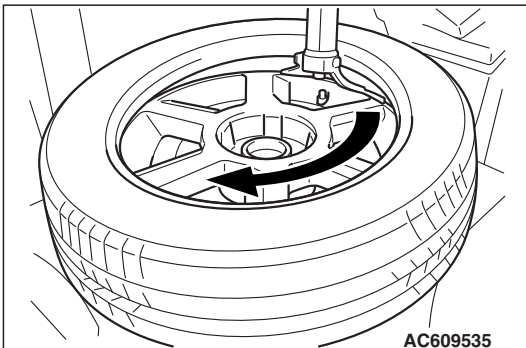

- Turn the wheel in order to engage all the first side of the tire.
NOTE: The standard shoes can pass over the sensor without damaging it.

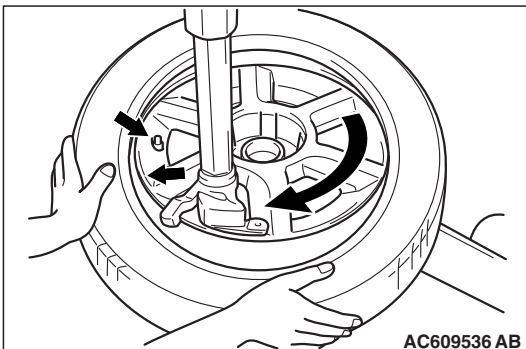

- Put the second side of the tire in position, so that the cross point of the belt with the rim is approximately 20 cm (7.9 inch) away from the valve. The curved arrow shows the direction of rotation of the wheel.

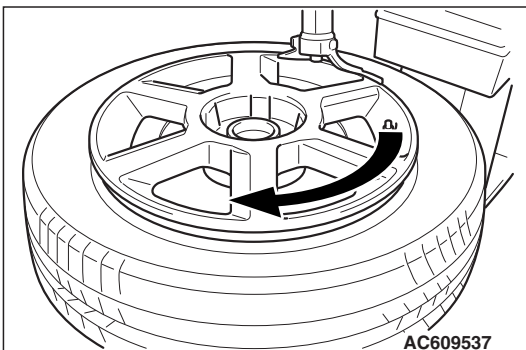

- Turn the wheel in order to engage all of the second side of the tire.
NOTE: The standard shoes can pass over the sensor without damaging it.

>>C<< TIRE PRESSURE INFLATION/NUT RETIGHTENING

⚠ CAUTION

After tire inflation, retighten the valve nut to $8.0 \pm 0.5 \text{ N} \cdot \text{m}$ ($71 \pm 4 \text{ in} \cdot \text{lb}$). This is necessary, because the TPMS transmitter is secured to the wheel with the valve nut and rubber grommet. The rubber grommet will be depressed by tire pressure or deteriorate over a period of time, which requires the valve nut to be retightened.

Inflate tire to required pressure, then retorquer the valve nut to $8.0 \pm 0.5 \text{ N} \cdot \text{m}$ ($71 \pm 4 \text{ in} \cdot \text{lb}$).